

Operating Manual



Universal Radio Communication Tester

R&S® CMU 200

1100.0008.02/10/30/53

R&S® CMU 300

1100.0008.03

Printed in Germany



© 2008 Rohde & Schwarz GmbH & Co. KG

81671 Munich, Germany

Printed in Germany – Subject to change – Data without tolerance limits is not binding.

R&S® is a registered trademark of Rohde & Schwarz GmbH & Co. KG.

Trade names are trademarks of the owners.

The following abbreviations are used throughout this manual:

R&S®CMU is abbreviated as R&S CMU or CMU.

Options R&S®CMU-xxx are abbreviated as R&S CMU-xxx or CMU-xxx (e.g. CMU-B41).

Tabbed Divider Overview

Safety Instructions

Tabbed Divider

| | |
|-----------|---|
| 1 | Chapter 1: Preparing for Use |
| 2 | Chapter 2: Getting Started |
| 3 | Chapter 3: Manual Operation |
| 4 | Chapter 4: Functions and their Application |
| 5 | Chapter 5: Remote Control – Basics |
| 6 | Chapter 6: Remote Control – Commands |
| 7 | Chapter 7: Remote Control – Program Examples |
| 8 | Chapter 8: Maintenance and Interfaces |
| 9 | Chapter 9: Error Messages |
| 10 | Index |

Basic Safety Instructions

Always read through and comply with the following safety instructions!















All plants and locations of the Rohde & Schwarz group of companies make every effort to keep the safety standards of our products up to date and to offer our customers the highest possible degree of safety. Our products and the auxiliary equipment they require are designed, built and tested in accordance with the safety standards that apply in each case. Compliance with these standards is continuously monitored by our quality assurance system. The product described here has been designed, built and tested in accordance with the attached EC Certificate of Conformity and has left the manufacturer's plant in a condition fully complying with safety standards. To maintain this condition and to ensure safe operation, you must observe all instructions and warnings provided in this manual. If you have any questions regarding these safety instructions, the Rohde & Schwarz group of companies will be happy to answer them.

Furthermore, it is your responsibility to use the product in an appropriate manner. This product is designed for use solely in industrial and laboratory environments or, if expressly permitted, also in the field and must not be used in any way that may cause personal injury or property damage. You are responsible if the product is used for any intention other than its designated purpose or in disregard of the manufacturer's instructions. The manufacturer shall assume no responsibility for such use of the product.

The product is used for its designated purpose if it is used in accordance with its product documentation and within its performance limits (see data sheet, documentation, the following safety instructions). Using the product requires technical skills and a basic knowledge of English. It is therefore essential that only skilled and specialized staff or thoroughly trained personnel with the required skills be allowed to use the product. If personal safety gear is required for using Rohde & Schwarz products, this will be indicated at the appropriate place in the product documentation. Keep the basic safety instructions and the product documentation in a safe place and pass them on to the subsequent users.





Observing the safety instructions will help prevent personal injury or damage of any kind caused by dangerous situations. Therefore, carefully read through and adhere to the following safety instructions before and when using the product. It is also absolutely essential to observe the additional safety instructions on personal safety, for example, that appear in relevant parts of the product documentation. In these safety instructions, the word "product" refers to all merchandise sold and distributed by the Rohde & Schwarz group of companies, including instruments, systems and all accessories.

Symbols and safety labels

| | | | | | | | |
|---|---|---|---|--|---|---|---|
|  |  |  |  |  |  |  |  |
| Notice, general danger location Observe product documentation | Caution when handling heavy equipment | Danger of electric shock | Warning! Hot surface | PE terminal | Ground | Ground terminal | Be careful when handling electrostatic sensitive devices |
|  |  |  |  |  |  | | |
| ON/OFF supply voltage | Standby indication | Direct current (DC) | Alternating current (AC) | Direct/alternating current (DC/AC) | Device fully protected by double (reinforced) insulation | | |

Tags and their meaning

The following signal words are used in the product documentation in order to warn the reader about risks and dangers.

| | |
|---|---|
|  | indicates a hazardous situation which, if not avoided, will result in death or serious injury. |
|  | indicates a hazardous situation which, if not avoided, could result in death or serious injury. |
|  | indicates a hazardous situation which, if not avoided, could result in minor or moderate injury. |
|  | indicates the possibility of incorrect operation which can result in damage to the product. In the product documentation, the word ATTENTION is used synonymously. |

These tags are in accordance with the standard definition for civil applications in the European Economic Area. Definitions that deviate from the standard definition may also exist in other economic areas or military applications. It is therefore essential to make sure that the tags described here are always used only in connection with the related product documentation and the related product. The use of tags in connection with unrelated products or documentation can result in misinterpretation and in personal injury or material damage.

Operating states and operating positions

The product may be operated only under the operating conditions and in the positions specified by the manufacturer, without the product's ventilation being obstructed. If the manufacturer's specifications are not observed, this can result in electric shock, fire and/or serious personal injury or death. Applicable local or national safety regulations and rules for the prevention of accidents must be observed in all work performed.

1. Unless otherwise specified, the following requirements apply to Rohde & Schwarz products: predefined operating position is always with the housing floor facing down, IP protection 2X, pollution severity 2, overvoltage category 2, use only indoors, max. operating altitude 2000 m above sea level, max. transport altitude 4500 m above sea level. A tolerance of $\pm 10\%$ shall apply to the nominal voltage and $\pm 5\%$ to the nominal frequency.
2. Do not place the product on surfaces, vehicles, cabinets or tables that for reasons of weight or stability are unsuitable for this purpose. Always follow the manufacturer's installation instructions when installing the product and fastening it to objects or structures (e.g. walls and shelves). An installation that is not carried out as described in the product documentation could result in personal injury or death.
3. Do not place the product on heat-generating devices such as radiators or fan heaters. The ambient temperature must not exceed the maximum temperature specified in the product documentation or in the data sheet. Product overheating can cause electric shock, fire and/or serious personal injury or death.

Electrical safety

If the information on electrical safety is not observed either at all to the extent necessary, electric shock, fire and/or serious personal injury or death may occur.

1. Prior to switching on the product, always ensure that the nominal voltage setting on the product matches the nominal voltage of the AC supply network. If a different voltage is to be set, the power fuse of the product may have to be changed accordingly.
2. In the case of products of safety class I with movable power cord and connector, operation is permitted only on sockets with an earthing contact and protective earth connection.
3. Intentionally breaking the protective earth connection either in the feed line or in the product itself is not permitted. Doing so can result in the danger of an electric shock from the product. If extension cords or connector strips are implemented, they must be checked on a regular basis to ensure that they are safe to use.
4. If the product does not have a power switch for disconnection from the AC supply network, the plug of the connecting cable is regarded as the disconnecting device. In such cases, always ensure that the power plug is easily reachable and accessible at all times (corresponding to the length of connecting cable, approx. 2 m). Functional or electronic switches are not suitable for providing disconnection from the AC supply network. If products without power switches are integrated into racks or systems, a disconnecting device must be provided at the system level.
5. Never use the product if the power cable is damaged. Check the power cable on a regular basis to ensure that it is in proper operating condition. By taking appropriate safety measures and carefully laying the power cable, you can ensure that the cable will not be damaged and that no one can be hurt by, for example, tripping over the cable or suffering an electric shock.
6. The product may be operated only from TN/TT supply networks fused with max. 16 A (higher fuse only after consulting with the Rohde & Schwarz group of companies).
7. Do not insert the plug into sockets that are dusty or dirty. Insert the plug firmly and all the way into the socket. Otherwise, sparks that result in fire and/or injuries may occur.
8. Do not overload any sockets, extension cords or connector strips; doing so can cause fire or electric shocks.
9. For measurements in circuits with voltages $V_{\text{rms}} > 30 \text{ V}$, suitable measures (e.g. appropriate measuring equipment, fusing, current limiting, electrical separation, insulation) should be taken to avoid any hazards.
10. Ensure that the connections with information technology equipment, e.g. PCs or other industrial computers, comply with the IEC60950-1/EN60950-1 or IEC61010-1/EN 61010-1 standards that apply in each case.
11. Unless expressly permitted, never remove the cover or any part of the housing while the product is in operation. Doing so will expose circuits and components and can lead to injuries, fire or damage to the product.
12. If a product is to be permanently installed, the connection between the PE terminal on site and the product's PE conductor must be made first before any other connection is made. The product may be installed and connected only by a licensed electrician.
13. For permanently installed equipment without built-in fuses, circuit breakers or similar protective devices, the supply circuit must be fused in such a way that anyone who has access to the product, as well as the product itself, is adequately protected from injury or damage.

14. Use suitable overvoltage protection to ensure that no overvoltage (such as that caused by a bolt of lightning) can reach the product. Otherwise, the person operating the product will be exposed to the danger of an electric shock.
15. Any object that is not designed to be placed in the openings of the housing must not be used for this purpose. Doing so can cause short circuits inside the product and/or electric shocks, fire or injuries.
16. Unless specified otherwise, products are not liquid-proof (see also section "Operating states and operating positions", item 1. Therefore, the equipment must be protected against penetration by liquids. If the necessary precautions are not taken, the user may suffer electric shock or the product itself may be damaged, which can also lead to personal injury.
17. Never use the product under conditions in which condensation has formed or can form in or on the product, e.g. if the product has been moved from a cold to a warm environment. Penetration by water increases the risk of electric shock.
18. Prior to cleaning the product, disconnect it completely from the power supply (e.g. AC supply network or battery). Use a soft, non-linting cloth to clean the product. Never use chemical cleaning agents such as alcohol, acetone or diluents for cellulose lacquers.

Operation

1. Operating the products requires special training and intense concentration. Make sure that persons who use the products are physically, mentally and emotionally fit enough to do so; otherwise, injuries or material damage may occur. It is the responsibility of the employer/operator to select suitable personnel for operating the products.
2. Before you move or transport the product, read and observe the section titled "Transport".
3. As with all industrially manufactured goods, the use of substances that induce an allergic reaction (allergens) such as nickel cannot be generally excluded. If you develop an allergic reaction (such as a skin rash, frequent sneezing, red eyes or respiratory difficulties) when using a Rohde & Schwarz product, consult a physician immediately to determine the cause and to prevent health problems or stress.
4. Before you start processing the product mechanically and/or thermally, or before you take it apart, be sure to read and pay special attention to the section titled "Waste disposal", item 1.
5. Depending on the function, certain products such as RF radio equipment can produce an elevated level of electromagnetic radiation. Considering that unborn babies require increased protection, pregnant women must be protected by appropriate measures. Persons with pacemakers may also be exposed to risks from electromagnetic radiation. The employer/operator must evaluate workplaces where there is a special risk of exposure to radiation and, if necessary, take measures to avert the potential danger.
6. Should a fire occur, the product may release hazardous substances (gases, fluids, etc.) that can cause health problems. Therefore, suitable measures must be taken, e.g. protective masks and protective clothing must be worn.
7. If a laser product (e.g. a CD/DVD drive) is integrated into a Rohde & Schwarz product, absolutely no other settings or functions may be used as described in the product documentation. The objective is to prevent personal injury (e.g. due to laser beams).

Repair and service

1. The product may be opened only by authorized, specially trained personnel. Before any work is performed on the product or before the product is opened, it must be disconnected from the AC supply network. Otherwise, personnel will be exposed to the risk of an electric shock.
2. Adjustments, replacement of parts, maintenance and repair may be performed only by electrical experts authorized by Rohde & Schwarz. Only original parts may be used for replacing parts relevant to safety (e.g. power switches, power transformers, fuses). A safety test must always be performed after parts relevant to safety have been replaced (visual inspection, PE conductor test, insulation resistance measurement, leakage current measurement, functional test). This helps ensure the continued safety of the product.

Batteries and rechargeable batteries/cells

If the information regarding batteries and rechargeable batteries/cells is not observed either at all or to the extent necessary, product users may be exposed to the risk of explosions, fire and/or serious personal injury, and, in some cases, death. Batteries and rechargeable batteries with alkaline electrolytes (e.g. lithium cells) must be handled in accordance with the EN 62133 standard.

1. Cells must not be taken apart or crushed.
2. Cells or batteries must not be exposed to heat or fire. Storage in direct sunlight must be avoided. Keep cells and batteries clean and dry. Clean soiled connectors using a dry, clean cloth.
3. Cells or batteries must not be short-circuited. Cells or batteries must not be stored in a box or in a drawer where they can short-circuit each other, or where they can be short-circuited by other conductive materials. Cells and batteries must not be removed from their original packaging until they are ready to be used.
4. Keep cells and batteries out of the hands of children. If a cell or a battery has been swallowed, seek medical aid immediately.
5. Cells and batteries must not be exposed to any mechanical shocks that are stronger than permitted.
6. If a cell develops a leak, the fluid must not be allowed to come into contact with the skin or eyes. If contact occurs, wash the affected area with plenty of water and seek medical aid.
7. Improperly replacing or charging cells or batteries that contain alkaline electrolytes (e.g. lithium cells) can cause explosions. Replace cells or batteries only with the matching Rohde & Schwarz type (see parts list) in order to ensure the safety of the product.
8. Cells and batteries must be recycled and kept separate from residual waste. Rechargeable batteries and normal batteries that contain lead, mercury or cadmium are hazardous waste. Observe the national regulations regarding waste disposal and recycling.

Transport

1. The product may be very heavy. Therefore, the product must be handled with care. In some cases, the user may require a suitable means of lifting or moving the product (e.g. with a lift-truck) to avoid back or other physical injuries.

2. Handles on the products are designed exclusively to enable personnel to transport the product. It is therefore not permissible to use handles to fasten the product to or on transport equipment such as cranes, fork lifts, wagons, etc. The user is responsible for securely fastening the products to or on the means of transport or lifting. Observe the safety regulations of the manufacturer of the means of transport or lifting. Noncompliance can result in personal injury or material damage.
3. If you use the product in a vehicle, it is the sole responsibility of the driver to drive the vehicle safely and properly. The manufacturer assumes no responsibility for accidents or collisions. Never use the product in a moving vehicle if doing so could distract the driver of the vehicle. Adequately secure the product in the vehicle to prevent injuries or other damage in the event of an accident.

Waste disposal

1. If products or their components are mechanically and/or thermally processed in a manner that goes beyond their intended use, hazardous substances (heavy-metal dust such as lead, beryllium, nickel) may be released. For this reason, the product may only be disassembled by specially trained personnel. Improper disassembly may be hazardous to your health. National waste disposal regulations must be observed.
2. If handling the product releases hazardous substances or fuels that must be disposed of in a special way, e.g. coolants or engine oils that must be replenished regularly, the safety instructions of the manufacturer of the hazardous substances or fuels and the applicable regional waste disposal regulations must be observed. Also observe the relevant safety instructions in the product documentation. The improper disposal of hazardous substances or fuels can cause health problems and lead to environmental damage.

Informaciones elementales de seguridad

Es imprescindible leer y observar las siguientes instrucciones e informaciones de seguridad!









El principio del grupo de empresas Rohde & Schwarz consiste en tener nuestros productos siempre al día con los estándares de seguridad y de ofrecer a nuestros clientes el máximo grado de seguridad. Nuestros productos y todos los equipos adicionales son siempre fabricados y examinados según las normas de seguridad vigentes. Nuestro sistema de garantía de calidad controla constantemente que sean cumplidas estas normas. El presente producto ha sido fabricado y examinado según el certificado de conformidad adjunto de la UE y ha salido de nuestra planta en estado impecable según los estándares técnicos de seguridad. Para poder preservar este estado y garantizar un funcionamiento libre de peligros, el usuario deberá atenerse a todas las indicaciones, informaciones de seguridad y notas de alerta. El grupo de empresas Rohde & Schwarz está siempre a su disposición en caso de que tengan preguntas referentes a estas informaciones de seguridad.







Además queda en la responsabilidad del usuario utilizar el producto en la forma debida. Este producto está destinado exclusivamente al uso en la industria y el laboratorio o, si ha sido expresamente autorizado, para aplicaciones de campo y de ninguna manera deberá ser utilizado de modo que alguna persona/cosa pueda sufrir daño. El uso del producto fuera de sus fines definidos o sin tener en cuenta las instrucciones del fabricante queda en la responsabilidad del usuario. El fabricante no se hace en ninguna forma responsable de consecuencias a causa del mal uso del producto.

Se parte del uso correcto del producto para los fines definidos si el producto es utilizado conforme a las indicaciones de la correspondiente documentación del producto y dentro del margen de rendimiento definido (ver hoja de datos, documentación, informaciones de seguridad que siguen). El uso del producto hace necesarios conocimientos técnicos y ciertos conocimientos del idioma inglés. Por eso se debe tener en cuenta que el producto solo pueda ser operado por personal especializado o personas instruidas en profundidad con las capacidades correspondientes. Si fuera necesaria indumentaria de seguridad para el uso de productos de Rohde & Schwarz, encontraría la información debida en la documentación del producto en el capítulo correspondiente. Guarde bien las informaciones de seguridad elementales, así como la documentación del producto, y entréguelas a usuarios posteriores.

Tener en cuenta las informaciones de seguridad sirve para evitar en lo posible lesiones o daños por peligros de toda clase. Por eso es imprescindible leer detalladamente y comprender por completo las siguientes informaciones de seguridad antes de usar el producto, y respetarlas durante el uso del producto. Deberán tenerse en cuenta todas las demás informaciones de seguridad, como p. ej. las referentes a la protección de personas, que encontrarán en el capítulo correspondiente de la documentación del producto y que también son de obligado cumplimiento. En las presentes informaciones de seguridad se recogen todos los objetos que distribuye el grupo de empresas Rohde & Schwarz bajo la denominación de "producto", entre ellos también aparatos, instalaciones así como toda clase de accesorios.

Símbolos y definiciones de seguridad

| | | | | | | | |
|--|--|--|--|--|---|--|--|
|  |  |  |  |  |  |  |  |
| Aviso: punto de peligro general Observar la documentación del producto | Atención en el manejo de dispositivos de peso elevado | Peligro de choque eléctrico | Advertencia: superficie caliente | Conexión a conductor de protección | Conexión a tierra | Conexión a masa | Aviso: Cuidado en el manejo de dispositivos sensibles a la electrostática (ESD) |

| | | | | | |
|---|---|---|---|--|---|
|  |  |  |  |  |  |
| Tensión de alimentación de PUESTA EN MARCHA / PARADA | Indicación de estado de espera (Standby) | Corriente continua (DC) | Corriente alterna (AC) | Corriente continua / Corriente alterna (DC/AC) | El aparato está protegido en su totalidad por un aislamiento doble (reforzado) |

Palabras de señal y su significado

En la documentación del producto se utilizan las siguientes palabras de señal con el fin de advertir contra riesgos y peligros.



PELIGRO identifica un peligro inminente con riesgo elevado que provocará muerte o lesiones graves si no se evita.



ADVERTENCIA identifica un posible peligro con riesgo medio de provocar muerte o lesiones (graves) si no se evita.



ATENCIÓN identifica un peligro con riesgo reducido de provocar lesiones leves o moderadas si no se evita.



AVISO indica la posibilidad de utilizar mal el producto y, como consecuencia, dañarlo.

En la documentación del producto se emplea de forma sinónima el término CUIDADO.

Las palabras de señal corresponden a la definición habitual para aplicaciones civiles en el área económica europea. Pueden existir definiciones diferentes a esta definición en otras áreas económicas o en aplicaciones militares. Por eso se deberá tener en cuenta que las palabras de señal aquí descritas sean utilizadas siempre solamente en combinación con la correspondiente documentación del producto y solamente en combinación con el producto correspondiente. La utilización de las palabras de señal en combinación con productos o documentaciones que no les correspondan puede llevar a interpretaciones equivocadas y tener por consecuencia daños en personas u objetos.

Estados operativos y posiciones de funcionamiento

El producto solamente debe ser utilizado según lo indicado por el fabricante respecto a los estados operativos y posiciones de funcionamiento sin que se obstruya la ventilación. Si no se siguen las indicaciones del fabricante, pueden producirse choques eléctricos, incendios y/o lesiones graves con posible consecuencia de muerte. En todos los trabajos deberán ser tenidas en cuenta las normas nacionales y locales de seguridad del trabajo y de prevención de accidentes.

1. Si no se convino de otra manera, es para los productos Rohde & Schwarz válido lo que sigue: como posición de funcionamiento se define por principio la posición con el suelo de la caja para abajo, modo de protección IP 2X, grado de suciedad 2, categoría de sobrecarga eléctrica 2, uso solamente en estancias interiores, utilización hasta 2000 m sobre el nivel del mar, transporte hasta 4500 m sobre el nivel del mar. Se aplicará una tolerancia de $\pm 10\%$ sobre el voltaje nominal y de $\pm 5\%$ sobre la frecuencia nominal.
2. No sitúe el producto encima de superficies, vehículos, estantes o mesas, que por sus características de peso o de estabilidad no sean aptos para él. Siga siempre las instrucciones de instalación del fabricante cuando instale y asegure el producto en objetos o estructuras (p. ej. paredes y estantes). Si se realiza la instalación de modo distinto al indicado en la documentación del producto, pueden causarse lesiones o incluso la muerte.
3. No ponga el producto sobre aparatos que generen calor (p. ej. radiadores o calefactores). La temperatura ambiente no debe superar la temperatura máxima especificada en la documentación del producto o en la hoja de datos. En caso de sobrecalentamiento del producto, pueden producirse choques eléctricos, incendios y/o lesiones graves con posible consecuencia de muerte.

Seguridad eléctrica

Si no se siguen (o se siguen de modo insuficiente) las indicaciones del fabricante en cuanto a seguridad eléctrica, pueden producirse choques eléctricos, incendios y/o lesiones graves con posible consecuencia de muerte.

1. Antes de la puesta en marcha del producto se deberá comprobar siempre que la tensión preseleccionada en el producto coincida con la de la red de alimentación eléctrica. Si es necesario modificar el ajuste de tensión, también se deberán cambiar en caso dado los fusibles correspondientes del producto.
2. Los productos de la clase de protección I con alimentación móvil y enchufe individual solamente podrán enchufarse a tomas de corriente con contacto de seguridad y con conductor de protección conectado.
3. Queda prohibida la interrupción intencionada del conductor de protección, tanto en la toma de corriente como en el mismo producto. La interrupción puede tener como consecuencia el riesgo de que el producto sea fuente de choques eléctricos. Si se utilizan cables alargadores o regletas de enchufe, deberá garantizarse la realización de un examen regular de los mismos en cuanto a su estado técnico de seguridad.
4. Si el producto no está equipado con un interruptor para desconectarlo de la red, se deberá considerar el enchufe del cable de conexión como interruptor. En estos casos se deberá asegurar que el enchufe siempre sea de fácil acceso (de acuerdo con la longitud del cable de conexión, aproximadamente 2 m). Los interruptores de función o electrónicos no son aptos para el corte de la red eléctrica. Si los productos sin interruptor están integrados en bastidores o instalaciones, se deberá colocar el interruptor en el nivel de la instalación.
5. No utilice nunca el producto si está dañado el cable de conexión a red. Compruebe regularmente el correcto estado de los cables de conexión a red. Asegúrese, mediante las medidas de protección y de instalación adecuadas, de que el cable de conexión a red no pueda ser dañado o de que nadie pueda ser dañado por él, p. ej. al tropezar o por un choque eléctrico.
6. Solamente está permitido el funcionamiento en redes de alimentación TN/TT aseguradas con fusibles de 16 A como máximo (utilización de fusibles de mayor amperaje solo previa consulta con el grupo de empresas Rohde & Schwarz).
7. Nunca conecte el enchufe en tomas de corriente sucias o llenas de polvo. Introduzca el enchufe por completo y fuertemente en la toma de corriente. La no observación de estas medidas puede provocar chispas, fuego y/o lesiones.
8. No sobrecargue las tomas de corriente, los cables alargadores o las regletas de enchufe ya que esto podría causar fuego o choques eléctricos.
9. En las mediciones en circuitos de corriente con una tensión $U_{\text{eff}} > 30 \text{ V}$ se deberán tomar las medidas apropiadas para impedir cualquier peligro (p. ej. medios de medición adecuados, seguros, limitación de tensión, corte protector, aislamiento etc.).
10. Para la conexión con dispositivos informáticos como un PC o un ordenador industrial, debe comprobarse que éstos cumplan los estándares IEC60950-1/EN60950-1 o IEC61010-1/EN 61010-1 válidos en cada caso.
11. A menos que esté permitido expresamente, no retire nunca la tapa ni componentes de la carcasa mientras el producto esté en servicio. Esto pone a descubierto los cables y componentes eléctricos y puede causar lesiones, fuego o daños en el producto.

12. Si un producto se instala en un lugar fijo, se deberá primero conectar el conductor de protección fijo con el conductor de protección del producto antes de hacer cualquier otra conexión. La instalación y la conexión deberán ser efectuadas por un electricista especializado.
13. En el caso de dispositivos fijos que no estén provistos de fusibles, interruptor automático ni otros mecanismos de seguridad similares, el circuito de alimentación debe estar protegido de modo que todas las personas que puedan acceder al producto, así como el producto mismo, estén a salvo de posibles daños.
14. Todo producto debe estar protegido contra sobretensión (debida p. ej. a una caída del rayo) mediante los correspondientes sistemas de protección. Si no, el personal que lo utilice quedará expuesto al peligro de choque eléctrico.
15. No debe introducirse en los orificios de la caja del aparato ningún objeto que no esté destinado a ello. Esto puede producir cortocircuitos en el producto y/o puede causar choques eléctricos, fuego o lesiones.
16. Salvo indicación contraria, los productos no están impermeabilizados (ver también el capítulo "Estados operativos y posiciones de funcionamiento", punto 1). Por eso es necesario tomar las medidas necesarias para evitar la entrada de líquidos. En caso contrario, existe peligro de choque eléctrico para el usuario o de daños en el producto, que también pueden redundar en peligro para las personas.
17. No utilice el producto en condiciones en las que pueda producirse o ya se hayan producido condensaciones sobre el producto o en el interior de éste, como p. ej. al desplazarlo de un lugar frío a otro caliente. La entrada de agua aumenta el riesgo de choque eléctrico.
18. Antes de la limpieza, desconecte por completo el producto de la alimentación de tensión (p. ej. red de alimentación o batería). Realice la limpieza de los aparatos con un paño suave, que no se deshilache. No utilice bajo ningún concepto productos de limpieza químicos como alcohol, acetona o diluyentes para lacas nitrocelulósicas.

Funcionamiento

1. El uso del producto requiere instrucciones especiales y una alta concentración durante el manejo. Debe asegurarse que las personas que manejen el producto estén a la altura de los requerimientos necesarios en cuanto a aptitudes físicas, psíquicas y emocionales, ya que de otra manera no se pueden excluir lesiones o daños de objetos. El empresario u operador es responsable de seleccionar el personal usuario apto para el manejo del producto.
2. Antes de desplazar o transportar el producto, lea y tenga en cuenta el capítulo "Transporte".
3. Como con todo producto de fabricación industrial no puede quedar excluida en general la posibilidad de que se produzcan alergias provocadas por algunos materiales empleados, los llamados alérgenos (p. ej. el níquel). Si durante el manejo de productos Rohde & Schwarz se producen reacciones alérgicas, como p. ej. irritaciones cutáneas, estornudos continuos, enrojecimiento de la conjuntiva o dificultades respiratorias, debe avisarse inmediatamente a un médico para investigar las causas y evitar cualquier molestia o daño a la salud.
4. Antes de la manipulación mecánica y/o térmica o el desmontaje del producto, debe tenerse en cuenta imprescindiblemente el capítulo "Eliminación", punto 1.

5. Ciertos productos, como p. ej. las instalaciones de radiocomunicación RF, pueden a causa de su función natural, emitir una radiación electromagnética aumentada. Deben tomarse todas las medidas necesarias para la protección de las mujeres embarazadas. También las personas con marcapasos pueden correr peligro a causa de la radiación electromagnética. El empresario/operador tiene la obligación de evaluar y señalar las áreas de trabajo en las que exista un riesgo elevado de exposición a radiaciones.
6. Tenga en cuenta que en caso de incendio pueden desprenderse del producto sustancias tóxicas (gases, líquidos etc.) que pueden generar daños a la salud. Por eso, en caso de incendio deben usarse medidas adecuadas, como p. ej. máscaras antigás e indumentaria de protección.
7. En caso de que un producto Rohde & Schwarz contenga un producto láser (p. ej. un lector de CD/DVD), no debe usarse ninguna otra configuración o función aparte de las descritas en la documentación del producto, a fin de evitar lesiones (p. ej. debidas a irradiación láser).

Reparación y mantenimiento

1. El producto solamente debe ser abierto por personal especializado con autorización para ello. Antes de manipular el producto o abrirlo, es obligatorio desconectarlo de la tensión de alimentación, para evitar toda posibilidad de choque eléctrico.
2. El ajuste, el cambio de partes, el mantenimiento y la reparación deberán ser efectuadas solamente por electricistas autorizados por Rohde & Schwarz. Si se reponen partes con importancia para los aspectos de seguridad (p. ej. el enchufe, los transformadores o los fusibles), solamente podrán ser sustituidos por partes originales. Después de cada cambio de partes relevantes para la seguridad deberá realizarse un control de seguridad (control a primera vista, control del conductor de protección, medición de resistencia de aislamiento, medición de la corriente de fuga, control de funcionamiento). Con esto queda garantizada la seguridad del producto.

Baterías y acumuladores o celdas

Si no se siguen (o se siguen de modo insuficiente) las indicaciones en cuanto a las baterías y acumuladores o celdas, pueden producirse explosiones, incendios y/o lesiones graves con posible consecuencia de muerte. El manejo de baterías y acumuladores con electrolitos alcalinos (p. ej. celdas de litio) debe seguir el estándar EN 62133.

1. No deben desmontarse, abrirse ni triturarse las celdas.
2. Las celdas o baterías no deben someterse a calor ni fuego. Debe evitarse el almacenamiento a la luz directa del sol. Las celdas y baterías deben mantenerse limpias y secas. Limpiar las conexiones sucias con un paño seco y limpio.
3. Las celdas o baterías no deben cortocircuitarse. Es peligroso almacenar las celdas o baterías en estuches o cajones en cuyo interior puedan cortocircuitarse por contacto recíproco o por contacto con otros materiales conductores. No deben extraerse las celdas o baterías de sus embalajes originales hasta el momento en que vayan a utilizarse.
4. Mantener baterías y celdas fuera del alcance de los niños. En caso de ingestión de una celda o batería, avisar inmediatamente a un médico.
5. Las celdas o baterías no deben someterse a impactos mecánicos fuertes indebidos.

6. En caso de falta de estanqueidad de una celda, el líquido vertido no debe entrar en contacto con la piel ni los ojos. Si se produce contacto, lavar con agua abundante la zona afectada y avisar a un médico.
7. En caso de cambio o recarga inadecuados, las celdas o baterías que contienen electrolitos alcalinos (p. ej. las celdas de litio) pueden explotar. Para garantizar la seguridad del producto, las celdas o baterías solo deben ser sustituidas por el tipo Rohde & Schwarz correspondiente (ver lista de recambios).
8. Las baterías y celdas deben reciclarse y no deben tirarse a la basura doméstica. Las baterías o acumuladores que contienen plomo, mercurio o cadmio deben tratarse como residuos especiales. Respete en esta relación las normas nacionales de eliminación y reciclaje.

Transporte

1. El producto puede tener un peso elevado. Por eso es necesario desplazarlo o transportarlo con precaución y, si es necesario, usando un sistema de elevación adecuado (p. ej. una carretilla elevadora), a fin de evitar lesiones en la espalda u otros daños personales.
2. Las asas instaladas en los productos sirven solamente de ayuda para el transporte del producto por personas. Por eso no está permitido utilizar las asas para la sujeción en o sobre medios de transporte como p. ej. grúas, carretillas elevadoras de horquilla, carros etc. Es responsabilidad suya fijar los productos de manera segura a los medios de transporte o elevación. Para evitar daños personales o daños en el producto, siga las instrucciones de seguridad del fabricante del medio de transporte o elevación utilizado.
3. Si se utiliza el producto dentro de un vehículo, recae de manera exclusiva en el conductor la responsabilidad de conducir el vehículo de manera segura y adecuada. El fabricante no asumirá ninguna responsabilidad por accidentes o colisiones. No utilice nunca el producto dentro de un vehículo en movimiento si esto pudiera distraer al conductor. Asegure el producto dentro del vehículo debidamente para evitar, en caso de un accidente, lesiones u otra clase de daños.

Eliminación

1. Si se trabaja de manera mecánica y/o térmica cualquier producto o componente más allá del funcionamiento previsto, pueden liberarse sustancias peligrosas (polvos con contenido de metales pesados como p. ej. plomo, berilio o níquel). Por eso el producto solo debe ser desmontado por personal especializado con formación adecuada. Un desmontaje inadecuado puede ocasionar daños para la salud. Se deben tener en cuenta las directivas nacionales referentes a la eliminación de residuos.
2. En caso de que durante el trato del producto se formen sustancias peligrosas o combustibles que deban tratarse como residuos especiales (p. ej. refrigerantes o aceites de motor con intervalos de cambio definidos), deben tenerse en cuenta las indicaciones de seguridad del fabricante de dichas sustancias y las normas regionales de eliminación de residuos. Tenga en cuenta también en caso necesario las indicaciones de seguridad especiales contenidas en la documentación del producto. La eliminación incorrecta de sustancias peligrosas o combustibles puede causar daños a la salud o daños al medio ambiente.

Customer Information Regarding Product Disposal

The German Electrical and Electronic Equipment (ElektroG) Act is an implementation of the following EC directives:

- 2002/96/EC on waste electrical and electronic equipment (WEEE) and
- 2002/95/EC on the restriction of the use of certain hazardous substances in electrical and electronic equipment (RoHS).

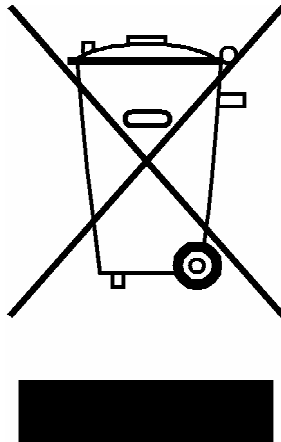

Product labeling in accordance with EN 50419

Once the lifetime of a product has ended, this product must not be disposed of in the standard domestic refuse. Even disposal via the municipal collection points for waste electrical and electronic equipment is not permitted.

Rohde & Schwarz GmbH & Co. KG has developed a disposal concept for the environmental-friendly disposal or recycling of waste material and fully assumes its obligation as a producer to take back and dispose of electrical and electronic waste in accordance with the ElektroG Act.

Please contact your local service representative to dispose of the product.



Certified Quality System

DIN EN ISO 9001 : 2000
DIN EN 9100 : 2003
DIN EN ISO 14001 : 2004

DQS REG. NO 001954 QM UM

QUALITÄTSZERTIFIKAT

Sehr geehrter Kunde,
Sie haben sich für den Kauf eines Rohde & Schwarz-Produktes entschieden. Hiermit erhalten Sie ein nach modernsten Fertigungsmethoden hergestelltes Produkt. Es wurde nach den Regeln unseres Managementsystems entwickelt, gefertigt und geprüft. Das Rohde & Schwarz Managementsystem ist zertifiziert nach:

DIN EN ISO 9001:2000
DIN EN 9100:2003
DIN EN ISO 14001:2004

CERTIFICATE OF QUALITY

Dear Customer,
you have decided to buy a Rohde & Schwarz product. You are thus assured of receiving a product that is manufactured using the most modern methods available. This product was developed, manufactured and tested in compliance with our quality management system standards. The Rohde & Schwarz quality management system is certified according to:

DIN EN ISO 9001:2000
DIN EN 9100:2003
DIN EN ISO 14001:2004

CERTIFICAT DE QUALITÉ

Cher Client,
vous avez choisi d'acheter un produit Rohde & Schwarz. Vous disposez donc d'un produit fabriqué d'après les méthodes les plus avancées. Le développement, la fabrication et les tests respectent nos normes de gestion qualité. Le système de gestion qualité de Rohde & Schwarz a été homologué conformément aux normes:

DIN EN ISO 9001:2000
DIN EN 9100:2003
DIN EN ISO 14001:2004



Customer Support

Technical support – where and when you need it

For quick, expert help with any Rohde & Schwarz equipment, contact one of our Customer Support Centers. A team of highly qualified engineers provides telephone support and will work with you to find a solution to your query on any aspect of the operation, programming or applications of Rohde & Schwarz equipment.

Up-to-date information and upgrades

To keep your instrument up-to-date and to be informed about new application notes related to your instrument, please send an e-mail to the Customer Support Center stating your instrument and your wish. We will take care that you will get the right information.

USA & Canada

Monday to Friday (except US public holidays)
8:00 AM – 8:00 PM Eastern Standard Time (EST)

Tel. from USA 888-test-rsa (888-837-8772) (opt 2)
From outside USA +1 410 910 7800 (opt 2)
Fax +1 410 910 7801

E-mail CustomerSupport@rohde-schwarz.com

East Asia

Monday to Friday (except Singaporean public holidays)
8:30 AM – 6:00 PM Singapore Time (SGT)

Tel. +65 6 513 0488
Fax +65 6 846 1090

E-mail CustomerSupport@rohde-schwarz.com

Rest of the World

Monday to Friday (except German public holidays)
08:00 – 17:00 Central European Time (CET)

Tel. +49 89 4129 13774
Fax +49 (0) 89 41 29 637 78

E-mail CustomerSupport@rohde-schwarz.com



ROHDE & SCHWARZ

Address List

Headquarters, Plants and Subsidiaries

Headquarters

ROHDE & SCHWARZ GmbH & Co. KG
Mühlendorfstraße 15 · D-81671 München
P.O.Box 80 14 69 · D-81614 München

Phone +49 (89) 41 29-0
Fax +49 (89) 41 29-121 64
info.rs@rohde-schwarz.com

Plants

ROHDE & SCHWARZ Messgerätebau GmbH
Riedbachstraße 58 · D-87700 Memmingen
P.O.Box 16 52 · D-87686 Memmingen

Phone +49 (83 31) 1 08-0
+49 (83 31) 1 08-1124
info.rsmb@rohde-schwarz.com

ROHDE & SCHWARZ GmbH & Co. KG
Werk Teisnach
Kaikenrieder Straße 27 · D-94244 Teisnach
P.O.Box 11 49 · D-94240 Teisnach

Phone +49 (99 23) 8 50-0
Fax +49 (99 23) 8 50-174
info.rsdt@rohde-schwarz.com

ROHDE & SCHWARZ závod
Vimperk, s.r.o.
Location Spidrova 49
CZ-38501 Vimperk

Phone +420 (388) 45 21 09
Fax +420 (388) 45 21 13

ROHDE & SCHWARZ GmbH & Co. KG
Dienstleistungszentrum Köln
Graf-Zeppelin-Straße 18 · D-51147 Köln
P.O.Box 98 02 60 · D-51130 Köln

Phone +49 (22 03) 49-0
Fax +49 (22 03) 49 51-229
info.rsdc@rohde-schwarz.com
service.rsdc@rohde-schwarz.com

Subsidiaries

R&S BICK Mobilfunk GmbH
Fritz-Hahne-Str. 7 · D-31848 Bad Münder
P.O.Box 20 02 · D-31844 Bad Münder

Phone +49 (50 42) 9 98-0
Fax +49 (50 42) 9 98-105
info.bick@rohde-schwarz.com

ROHDE & SCHWARZ FTK GmbH
Wendenschloßstraße 168, Haus 28
D-12557 Berlin

Phone +49 (30) 658 91-122
Fax +49 (30) 655 50-221
info.ftk@rohde-schwarz.com

ROHDE & SCHWARZ SIT GmbH
Am Studio 3
D-12489 Berlin

Phone +49 (30) 658 84-0
Fax +49 (30) 658 84-183
info.sit@rohde-schwarz.com

R&S Systems GmbH
Graf-Zeppelin-Straße 18
D-51147 Köln

Phone +49 (22 03) 49-5 23 25
Fax +49 (22 03) 49-5 23 36
info.rssys@rohde-schwarz.com

GEDIS GmbH
Sophienblatt 100
D-24114 Kiel

Phone +49 (431) 600 51-0
Fax +49 (431) 600 51-11
sales@gedis-online.de

HAMEG Instruments GmbH
Industriestraße 6
D-63533 Mainhausen

Phone +49 (61 82) 800-0
Fax +49 (61 82) 800-100
info@hameg.de

Locations Worldwide

Please refer to our homepage: www.rohde-schwarz.com

- ◆ Sales Locations
- ◆ Service Locations
- ◆ National Websites

What's New in this Revision...

This operating manual describes version V5.00 and higher of the R&S CMU base software including *RF* and *Audio* measurements (option R&S CMU-B41), the IQ-IF interface (option R&S CMU-B17) and the FM Stereo Transmitter (option R&S CMU-K14). The new features since firmware version 4.30 are listed below.

| New Features | Description | Refer to... |
|--|---|---|
| Audio extensions (FW V4.30 / V4.50) | Total Harmonic Noise (<i>THD</i>) measurement <i>Stereo</i> applications for <i>Multitone</i> and <i>THD</i> measurements | Chapter 4, → Audio Option (R&S CMU-B41) |
| Generator List Mode (FW V4.51) | Generator can be confined to a sequence of steps within the entire frequency list. | Chapter 4, → RF Measurements |
| Results report mode (FW V4.51) | Display filter, selects only <code>READ...?</code> and <code>FETCH...?</code> commands and results for display in the remote screen. | Chapter 5, → Indications during Rem. Control |
| Subarray commands (FW V5.00) | Subarray commands can also return arithmetic mean values (<code>PAVG</code>) and x-axis values for minima and maxima (<code>XMINimum</code> , <code>XMAXimum</code>). | Chapter 5, → Retrieving Measurement Results |
| Version Manager (FW V5.00) | Redesign and improvements in the Version Manager. | Chapter 1, → R&S CMU Version Manager |
| Utility commands (FW V5.00) | <code>SYSTEM:REBoot</code> reboots the instrument <code>SYSTEM:REBoot:ERRor</code> reboots the instrument when a non-recoverable system error is encountered | Chapter 6, → System Commands |

Frequently Used Abbreviations

| | |
|---------|--|
| AF | Audio Frequency |
| AM | Amplitude Modulation |
| Att. | Attenuation |
| Cnt. | Center |
| DSB | Double Sideband |
| Ext. | External |
| FM | Frequency Modulation |
| Freq. | Frequency |
| FW | Firmware |
| GPIO | General Purpose Interface Bus = IEEE Bus according to standard IEC 625.1/IEEE 488.1 |
| IF | Intermediate Frequency |
| I/Q | In-band and quadrature components (baseband signal) |
| Max. | Maximum (Level) |
| Pk | Peak |
| RBW | Resolution Bandwidth |
| Ref. | Reference |
| Rel. | Relative |
| RF | Radio Frequency |
| SCPI | Standard Commands for Programmable Instruments |
| SSB | Single Sideband |
| SW | Software |
| THD | Total Harmonic Distortion |
| THD + N | Total Harmonic Distortion and Noise |

Supplement to the Operating Manual R&S® CMU 200/300

New Features in Firmware Version 5.10

Dear CMU Customer,

With firmware version V5.10 the frequency-dependent attenuation settings have been extended. The R&S® CMU supports separate RX and TX correction tables, each with up to 100 independent frequency and attenuation values. The extended frequency attenuation settings are available in all function groups. This supplement contains the updated documentation.

The new firmware version also provides a batch file that you can use to write log files to an external storage medium.

Frequency-Dependent External Attenuation

The *Ext. Att. Output* or *Ext. Att. Input* softkeys in the *RF*  tab of the *Connection Control* menu open a popup dialog to define the external input and output attenuation factors as a function of the RF input (analyzer) and output (generator) frequency. The frequency-dependent attenuations have the same meaning and effect as the global (frequency-independent) attenuations *Ext. Att. Input* and *Ext. Att. Output*:

- A positive (negative) output attenuation increases (decreases) the RF generator level so that the generator compensates for the external attenuation or gain.
- A positive (negative) input attenuation increases (decreases) the displayed RF analyzer level so that the displayed result corresponds to the output transmit power of the DUT.

Frequency-dependent attenuations replace the global (frequency-independent) attenuations *Ext. Att. Input* and *Ext. Att. Output*. In contrast to the global attenuations, they are valid for all function groups (in remote control, the commands must be addressed in the R&S CMU base system).

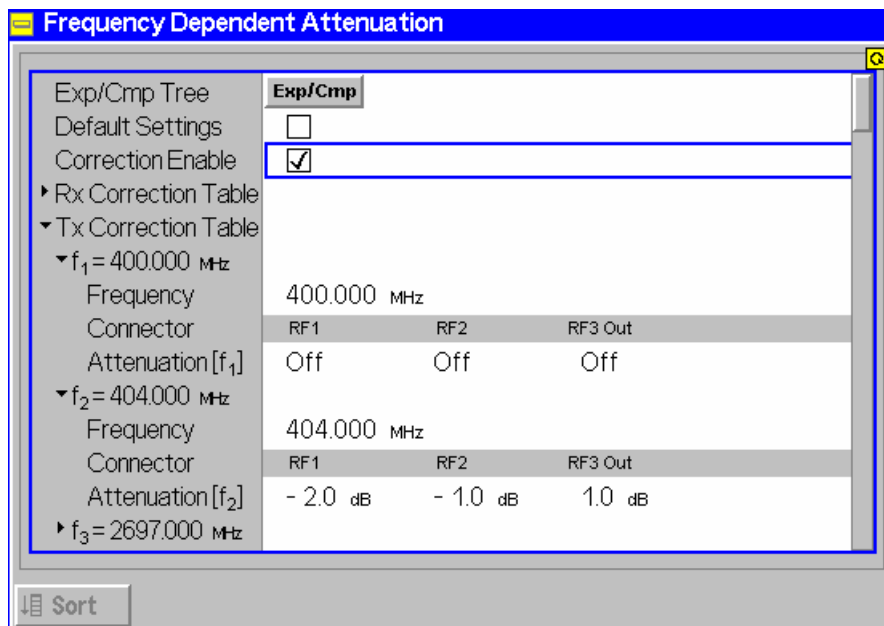



Fig. 4-1 Frequency-dependent attenuation

Default Settings Disables the frequency-dependent correction and sets all frequency values and all external attenuation factors to *Off*.

Correction Enable Enables the frequency-dependent attenuations, causing the global input and output attenuation to be replaced. A red status message in the *RF*  tab indicates that the frequency-dependent attenuations are enabled.

Rx or TX Correction Table – f_1 to f_{100} List of 100 frequency values, to be set to a specific frequency in the RF input (RX) or output (TX) frequency range of the R&S CMU (see data sheet) or to *Off*, if the frequency point is not used. The frequencies in the RX and TX correction tables are independent from each other.

Attenuation [f_n] External input and output attenuation factors at the frequency points f_n .

- The *RX Correction Table* defines input attenuation factors for the RF connectors *RF1, RF2, RF4 IN*.
- The *TX Correction Table* defines output attenuation factors for the RF connectors *RF1, RF2, RF3 OUT*.

The input and output attenuation values for the bidirectional connectors *RF1* and *RF2* in the two correction tables are independent from each other.

The frequency points do not have to be defined in ascending order. Off the specified frequency points the attenuation factors are calculated as follows:

- In an interval between two adjacent frequency points, the attenuations are linearly interpolated.
- The attenuation at the lowest frequency point is valid for all analyzer or generator frequencies below and up to this frequency.
- The attenuation at the highest frequency point is valid for all analyzer or generator frequencies above this frequency.

Following these rules, it is possible to define attenuation factors for the entire frequency range using an arbitrary number of frequency points between zero (no attenuation) and 100. Using a single frequency point is equivalent to the global (frequency-independent) attenuations *Ext. Att. Input* and *Ext. Att. Output*.

Generator RF Level and analyzer Max. Level ranges The frequency-dependent attenuation factors modify the setting ranges for the generator and analyzer level, in analogy to the global attenuation factors *Ext. Att. Input* and *Ext. Att. Output*.

- A positive (negative) output attenuation decreases (increases) the setting range of the RF generator level because the actual generator level must be larger (smaller) than the setting value.
- A positive (negative) input attenuation increases (decreases) the maximum analyzer level (RF Max. Level) because the displayed analyzer level result is larger (smaller) than the actual level at the input connectors of the R&S CMU.

To avoid conflicting level settings at varying input and output frequencies, the R&S CMU restricts the generator and analyzer setting ranges according to the maximum and minimum attenuation settings.



Sorts the frequencies f_1 to f_{100} in ascending order.

Remote control: The commands for the frequency-dependent attenuation are part of the CMU base system:

```

DEFault:USER:CORRection:LOSS
CONFigure:USER:CORRection:LOSS:TABLE...
CONFigure:USER:CORRection:LOSS:TXTable...
CONFigure:USER:CORRection:LOSS:RXTable...
SORT:USER:CORRection:LOSS:TABLE
    
```

Remote Control: Frequency-Dependent External Attenuation

The following commands define the frequency-dependent external input and output attenuation factors. The commands are valid for all function groups.

| DEFault:USER:CORRection:LOSS | | Default Setting | | |
|---|--|-----------------|-----------|----------|
| <Default Setting> | | | | |
| <Default Setting> | Description of parameters | Def. value | Def. unit | FW vers. |
| ON | The parameters are set to default values | ON | – | V3.60 |
| OFF | Some or all parameters are not set to default values | | | |
| Description of command | | | | |
| If used as a setting command with the parameter <i>ON</i> , this command sets all frequency-dependent external attenuation settings to their default values (the setting <i>OFF</i> results in an error message). | | | | |
| If used as a query the command returns whether all parameters are set to their default values (<i>ON</i>) or not (<i>OFF</i>). | | | | |

| CONFigure:USER:CORRection:LOSS:TABLE:ENABLE | | Frequency Dependent Attenuation Enable | | |
|---|---------------------------------------|--|-----------|----------|
| <Enable> | | | | |
| <Enable > | Description of parameters | Def. value | Def. unit | FW vers. |
| ON | The user correction table is active | OFF | – | V3.60 |
| OFF | The user correction table is inactive | | | |
| Description of command | | | | |
| This command enables or disables frequency-dependent attenuations, overwriting the global input and output attenuation factors. | | | | |

```

CONFigure:USER:CORRection:LOSS:TABLE                                RX Correction and TX Correction Tables
<Frequency[1]>,<Correction RF1[f1]>,<Correction RF2[f1]>,<Correction RF3 OUT[f1]>
,<Correction RF4 IN[f1]>
<Frequency[2]>,<Correction RF1[f2]>,<Correction RF2[f2]>,<Correction RF3 OUT[f2]>
,<Correction RF4 IN[f2]>
.....
<Frequency[100]>,<Correction RF1[f100]>,<Correction RF2[f100]>,<Correction RF3 OUT[f100]>
,<Correction RF4 IN[f100]>
    
```

| Parameters | Description of parameters | Def. value | Def. unit | FW vers. |
|---|---|---------------------------------|----------------------------|----------|
| 10 MHz to 2700 MHz OFF, -50 dB ... +90 dB OFF, -50 dB ... +90 dB OFF, -50 dB ... +90 dB OFF, -50 dB ... +90 dB OFF, | f ₁ or OFF if frequency is not used Attenuation for RF1 @ f ₁ Attenuation for RF2 @ f ₁ Attenuation for RF3 OUT @ f ₁ Attenuation for RF4 IN @ f ₁ | OFF OFF OFF OFF OFF | Hz dB dB dB dB | V5.10 |
| 10MHz to 2700MHz OFF , -50dB ... +90dB OFF, -50dB ... +90dB OFF, -50dB ... +90dB OFF, -50dB ... +90dB OFF, | f ₂ or OFF if frequency is not used Attenuation for RF1 @ f ₂ Attenuation for RF2 @ f ₂ Attenuation for RF3 OUT @ f ₂ Attenuation for RF4 IN @ f ₂ | OFF OFF OFF OFF OFF | Hz dB dB dB dB | |
| ... | ... | | ... | |
| 10MHz to 2700MHz OFF, -50dB ... +90dB OFF, -50dB ... +90dB OFF, -50dB ... +90dB OFF, -50dB ... +90dB OFF | f ₁₀₀ or OFF if frequency is not used Attenuation for RF1 @ f ₁₀₀ Attenuation for RF2 @ f ₁₀₀ Attenuation for RF3 OUT @ f ₁₀₀ Attenuation for RF4 IN @ f ₁₀₀ | OFF OFF OFF OFF OFF | Hz dB dB dB dB | |

Description of command

This command sets the whole content of the user correction loss tables. The attenuation factors for the bidirectional connectors RF1 and RF2 are used as input **and** output attenuation factors. Use the `CONFigure:USER:CORRection:LOSS:RXTable...` and `CONFigure:USER:CORRection:LOSS:TXTable...` commands to define different input and output attenuation factors.

The query form is available in firmware versions V3.60 and higher (50 different frequencies in firmware versions <V5.10). It returns the input attenuation factors for RF1, RF2, the output attenuation factor for RF3 OUT, and the input attenuation factor for RF4 IN.

CONFigure:USER:CORRection:LOSS:TXTable TX Correction Table
<Frequency[1]>,<Correction RF1[f1]>,<Correction RF2[f1]>,<Correction RF3 OUT[f1]>
<Frequency[2]>,<Correction RF1[f2]>,<Correction RF2[f2]>,<Correction RF3 OUT[f2]>
 ,....
<Frequency[100]>,<Correction RF1[f100]>,<Correction RF2[f100]>,<Correction RF3 OUT[f100]>

| Parameters | Description of parameters | Def. value | Def. unit | FW vers. |
|---|---|------------|-----------|----------|
| 10 MHz to 2700 MHz OFF, -50 dB ... +90 dB OFF, -50 dB ... +90 dB OFF, -50 dB ... +90 dB OFF, | f_1 or OFF if frequency is not used | OFF | Hz | V5.10 |
| | Attenuation for RF1 @ f_1 | OFF | dB | |
| | Attenuation for RF2 @ f_1 | OFF | dB | |
| | Attenuation for RF3 OUT @ f_1 | OFF | dB | |
| 10MHz to 2700MHz OFF , -50dB ... +90dB OFF, -50dB ... +90dB OFF, -50dB ... +90dB OFF, | f_2 or OFF if frequency is not used | OFF | Hz | |
| | Attenuation for RF1 @ f_2 | OFF | dB | |
| | Attenuation for RF2 @ f_2 | OFF | dB | |
| | Attenuation for RF3 OUT @ f_2 | OFF | dB | |
| ... | ... | | ... | |
| 10MHz to 2700MHz OFF, -50dB ... +90dB OFF, -50dB ... +90dB OFF, -50dB ... +90dB OFF | f_{100} or OFF if frequency is not used | OFF | Hz | |
| | Attenuation for RF1 @ f_{100} | OFF | dB | |
| | Attenuation for RF2 @ f_{100} | OFF | dB | |
| | Attenuation for RF3 OUT @ f_{100} | OFF | dB | |

Description of command

This command sets the whole content of the *TX Correction Table*.

CONFigure:USER:CORRection:LOSS:RXTable RX Correction Table
<Frequency[1]>,<Correction RF1[f1]>,<Correction RF2[f1]>,<Correction RF4 IN[f1]>
<Frequency[2]>,<Correction RF1[f2]>,<Correction RF2[f2]>,<Correction RF4 IN[f2]>
 ,....
<Frequency[100]>,<Correction RF1[f100]>,<Correction RF2[f100]>,<Correction RF4 IN[f100]>

| Parameters | Description of parameters | Def. value | Def. unit | FW vers. |
|---|---|------------|-----------|----------|
| 10 MHz to 2700 MHz OFF, -50 dB ... +90 dB OFF, -50 dB ... +90 dB OFF, -50 dB ... +90 dB OFF, | f_1 or OFF if frequency is not used | OFF | Hz | V5.10 |
| | Attenuation for RF1 @ f_1 | OFF | dB | |
| | Attenuation for RF2 @ f_1 | OFF | dB | |
| | Attenuation for RF4 IN @ f_1 | OFF | dB | |
| 10MHz to 2700MHz OFF , -50dB ... +90dB OFF, -50dB ... +90dB OFF, -50dB ... +90dB OFF, | f_2 or OFF if frequency is not used | OFF | Hz | |
| | Attenuation for RF1 @ f_2 | OFF | dB | |
| | Attenuation for RF2 @ f_2 | OFF | dB | |
| | Attenuation for RF4 IN @ f_2 | OFF | dB | |
| ... | ... | | ... | |
| 10MHz to 2700MHz OFF, -50dB ... +90dB OFF, -50dB ... +90dB OFF, -50dB ... +90dB OFF | f_{100} or OFF if frequency is not used | OFF | Hz | |
| | Attenuation for RF1 @ f_{100} | OFF | dB | |
| | Attenuation for RF2 @ f_{100} | OFF | dB | |
| | Attenuation for RF4 IN @ f_{100} | OFF | dB | |

Description of command

This command sets the whole content of the *RX Correction Table*.

| CONFigure:USER:CORRection:LOSS:TABLE:LINE<nr> | | RX / TX Correction at Specified Frequency | | |
|---|---|---|----------------------------|----------|
| <Frequency[<nr>],<Correction RF1[<nr>],<Correction RF2[<nr>],<Correction RF3 OUT[<nr>],<Correction RF4 IN[<nr>] | | | | |
| <Default Setting> | Description of parameters | Def. value | Def. unit | FW vers. |
| 10MHz to 2700MHz OFF, -50dB ... +90dB OFF, -50dB ... +90dB OFF, -50dB ... +90dB OFF, -50dB ... +90dB OFF | Frequency <nr> in the lists Attenuation for RF1 <nr>. Attenuation for RF2 <nr>. Attenuation for RF3 OUT <nr>. Attenuation for RF4 IN <nr> | OFF OFF OFF OFF OFF | Hz dB dB dB dB | V3.60 |
| Description of command | | | | |
| <p>This command defines the attenuation factors for each of the RF connectors and at the frequency specified by means of the numeric suffix <nr> = 1 to 100. The attenuation factors for the bidirectional connectors RF1 and RF2 are used as input and output attenuation factors. Use the <code>CONFigure:USER:CORRection:LOSS:RXTable...</code> and <code>CONFigure:USER:CORRection:LOSS:TXTable...</code> commands to define different input and output attenuation factors.</p> <p>In firmware versions <V5.10, the command supports 50 different frequencies (<nr> = 1 to 50). The query form returns the input attenuation factors for RF1, RF2, the output attenuation factor for RF3 OUT, and the input attenuation factor for RF4 IN.</p> | | | | |
| Note: Setting the frequency to <code>OFF</code> means that the frequency and the attenuation values are not used. | | | | |

| CONFigure:USER:CORRection:LOSS:TXTable:LINE<nr> | | TX Correction at Specified Frequency | | |
|---|---|--------------------------------------|----------------------|----------|
| <Frequency[<nr>],<Correction RF1[<nr>],<Correction RF2[<nr>],<Correction RF3 OUT[<nr>] | | | | |
| <Default Setting> | Description of parameters | Def. value | Def. unit | FW vers. |
| 10MHz to 2700MHz OFF, -50dB ... +90dB OFF, -50dB ... +90dB OFF, -50dB ... +90dB OFF | Frequency <nr> in the lists Attenuation for RF1 <nr>. Attenuation for RF2 <nr>. Attenuation for RF3 OUT <nr> | OFF OFF OFF OFF | Hz dB dB dB | V5.10 |
| Description of command | | | | |
| <p>This command defines the output attenuation factors for each of the RF connectors and at the frequency specified by means of the numeric suffix <nr> = 1 to 100.</p> | | | | |
| Note: Setting the frequency to <code>OFF</code> means that the frequency and the attenuation values are not used. | | | | |

| CONFigure:USER:CORRection:LOSS:RXTable:LINE<nr> | | RX Correction at Specified Frequency | | |
|--|--|--------------------------------------|----------------------|----------|
| <Frequency[<nr>],<Correction RF1[<nr>],<Correction RF2[<nr>],<Correction RF4 IN[<nr>] | | | | |
| <Default Setting> | Description of parameters | Def. value | Def. unit | FW vers. |
| 10MHz to 2700MHz OFF, -50dB ... +90dB OFF, -50dB ... +90dB OFF, -50dB ... +90dB OFF | Frequency <nr> in the lists Attenuation for RF1 <nr>. Attenuation for RF2 <nr>. Attenuation for RF4 IN <nr> | OFF OFF OFF OFF | Hz dB dB dB | V5.10 |
| Description of command | | | | |
| <p>This command defines the input attenuation factors for each of the RF connectors and at the frequency specified by means of the numeric suffix <nr> = 1 to 100.</p> | | | | |
| Note: Setting the frequency to <code>OFF</code> means that the frequency and the attenuation values are not used. | | | | |

| SORT:USER:CORRection:LOSS:TABLE | | Sort Table |
|---|--|------------|
| Description of command | | FW vers. |
| This command sorts the frequency table. Sorting has no effect to the user correction. | | V3.60 |

Saving and Copying Log Files

The R&S[®] CMU can generate a set of log files containing useful information for error diagnosis. A batch file for copying the log files to an external storage medium (e.g. a PCMCIA card) is available. Log files may be written during normal operation or after a software crash:

- On a running R&S[®] CMU, use an external keyboard and press ALT-F4.
- After a software crash (red box), simply press ENTER on the front panel. Do **not** use the ON/STANDBY key or the mains switch at the rear panel to shut down the instrument.

In both scenarios, the R&S[®] CMU writes log files to its internal hard disk and shuts down, taking you to the DOS command prompt. To copy the log files to a PCMCIA card, proceed as follows:

1. Insert the PCMCIA card into the right-hand PCMCIA slot of the R&S[®] CMU.
2. Type `get_log` to execute the `get_log.bat` file.

The batch file will generate an error message if no log files are available. Otherwise, you can send the log directory on the PCMCIA card to your local R&S representative.

Contents

| | |
|---|-------------|
| 1 Preparing the R&S CMU for Use | 1.1 |
| Front View | 1.1 |
| Rear View | 1.8 |
| Putting the Instrument into Operation | 1.11 |
| Unpacking the Instrument | 1.11 |
| Setting up the Instrument | 1.11 |
| Bench Top Operation | 1.11 |
| Mounting in a Rack | 1.12 |
| Connecting the Instrument to the AC Supply | 1.13 |
| Switching on the Instrument / Startup Test | 1.13 |
| Switching off the Instrument | 1.15 |
| How to Ensure EMC | 1.15 |
| Input Level | 1.15 |
| Connecting the CMU to the Test Setup | 1.16 |
| Connecting a Controller | 1.16 |
| Connecting an External Keyboard | 1.18 |
| Connecting a Monitor | 1.18 |
| Connecting a Printer | 1.19 |
| Synchronization with External Devices; Connection of Further Components | 1.19 |
| Software Update and Version Management | 1.20 |
| R&S Remote Service Tool | 1.20 |
| Remote Control of the R&S CMU | 1.27 |
| File <i>Versions.new</i> | 1.28 |
| CMU VersionManager | 1.29 |
| RF User Correction | 1.39 |
| Compiling and Loading User Correction Tables | 1.40 |
| File Format for User Correction Tables | 1.42 |
| Ranges of Values and Limitations | 1.42 |
| Interpolation Rules | 1.43 |

1 Preparing the R&S CMU for Use

This chapter describes the controls and connectors of the Universal Radio Communication Tester CMU and gives all information that is necessary to put the instrument into operation and connect external devices. Notes on reinstallation of the CMU software and a description of the *VersionManager* appear at the end of this chapter.

Caution!



Please observe the instructions of the following sections so that you cannot cause damage to the instrument or endanger people. This is of particular importance when you use the instrument for the first time. Also observe the general safety instructions at the beginning of this manual.

A more detailed description of the hardware connectors and interfaces can be found in chapter 8 of the complete operating manual. Chapter 2 of the operating manual provides an introduction to the operation of the CMU by means of typical examples of configuration and measurement; for a description of the operating concept refer to Chapter 3.

For remote control of the CMU refer to the general description of the SCPI commands, the instrument model, the status reporting system, and measurement control in Chapter 5 of the operating manual.

Front View

The front panel of the CMU consists of the VGA display with the softkey area (left side) and the hardkey area (right side, see Fig. 1-1). Brief explanations on the controls and connectors of the hardkey area and the rear panel are to be found on the next pages. Operation by means of softkeys is described in Chapter 3 of the operating manual, *Manual Operation*.

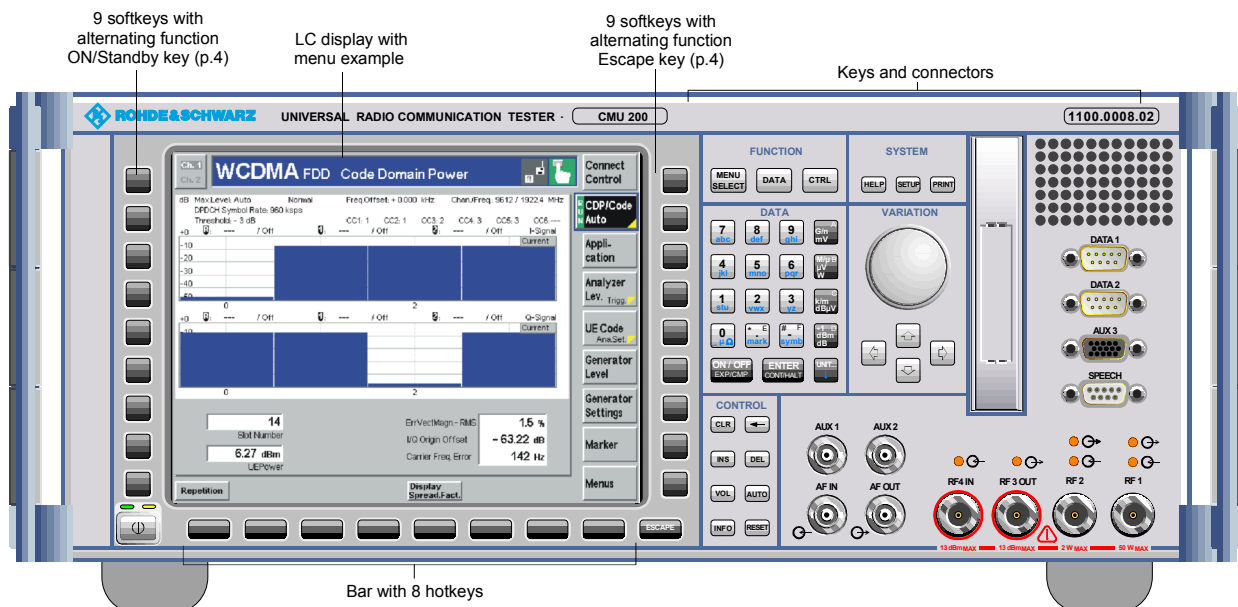

Fig. 1-1 CMU front view

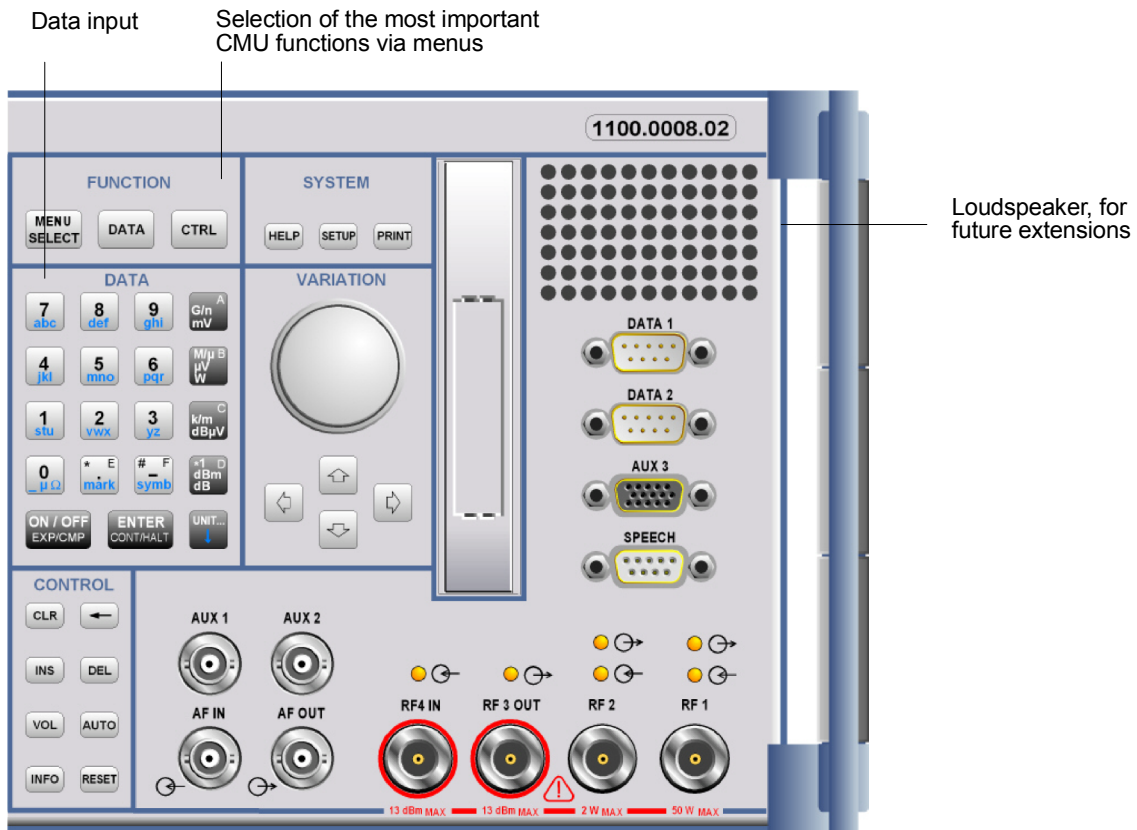

Fig. 1-2 CMU front view – hardkeys

FUNCTION

Operating manual



Preselection of the menus:

- MENU SELECT* Menu selection
- DATA* File manager
- CTRL* For GSMxxx-MS Signalling tests: Measurement Wizard

👉 Chap. 3
Chap. 4

DATA

Operating manual



Data input:

- 0 ... 9* Numerical input (letters for string editors)
- * . E* Special characters, dec. point, hex value "E"
- # - F* Spec. characters, sign change, hex value "F"
- G/n mV A* Factor $10^9/10^{-9}$, unit, hex value "A"
- M/μ μV W* Factor $10^6/10^{-6}$, unit, hex value "B"
- k/m dB μV* Factor $10^3/10^{-3}$, unit, hex value "C"
- *1 dBm dB* Factor 10^0 , unit, hex value "D"
- ON / OFF* Switching on/off editors/measurements
EXP/COMP
- ENTER* Confirmation of entry in editors
- CONT/HALT* Calling/quitting editors, measurement control
- UNIT ↕* For future extensions

👉 Chap. 3

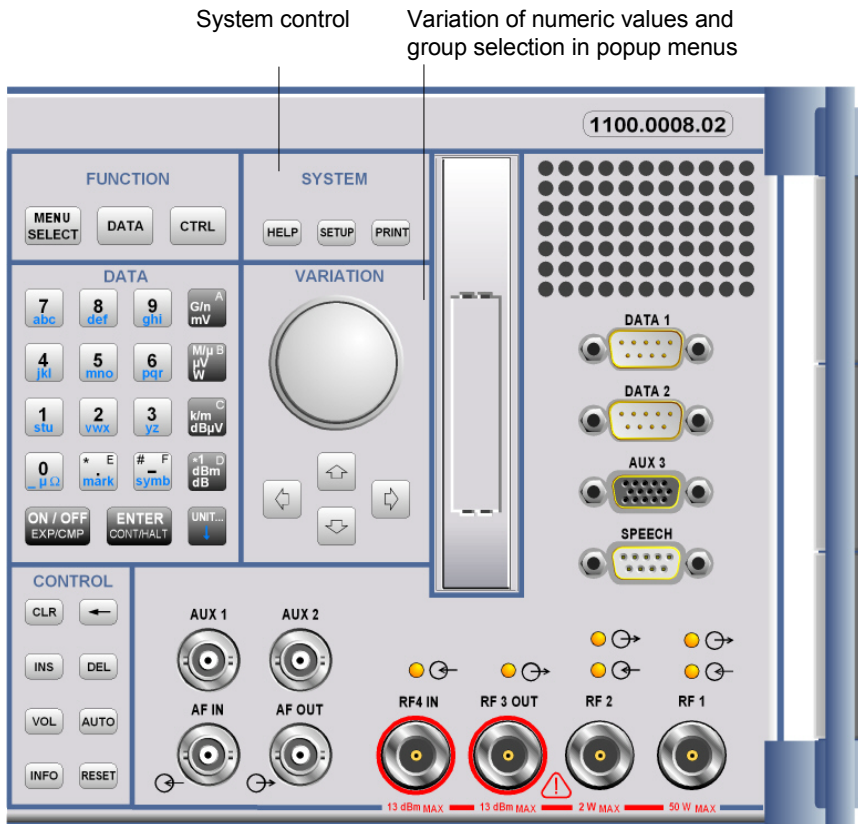

Fig. 1-3 CMU front view – hardkeys

SYSTEM

Operating manual



System control:

- HELP Displays online help
- SETUP Instrument settings
- PRINT Initialize printing of a screenshot

👉 Chap. 3

VARIATION

Operating manual



Value variation and group selection:

- Rotary knob Value variation in input fields and parameters, line selection in tables, field selection in popup menus. Press to expand/compress tables and pull-down lists and to confirm entries and selections.
- Cursor key vertical Group selection in popup menu (vertical)
- Cursor key horizontal Group selection in popup menu (horizontal), Cursor positioning in editors and tables

👉 Chap. 3

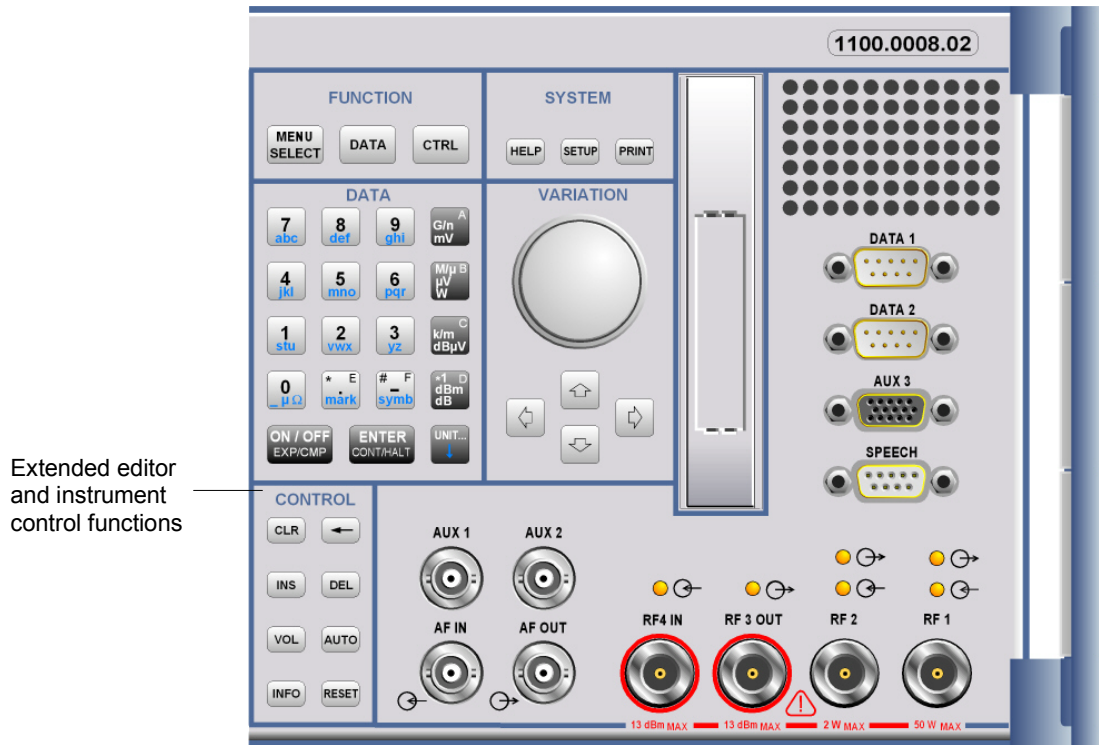

Fig. 1-4 CMU front view – hardkeys

CONTROL

Operating manual



Extended control functions:

- CLR** Clears the complete editor string
- ↵** Deletes the character to the left of the cursor (back space)
- INS** Changes between insertion and overwriting in the editor
- DEL** Deletes the character marked by the cursor
- VOL** For future extensions
- AUTO** For future extensions
- INFO** System info and hardware diagnosis
- RESET** Resets to default values

👉 Chap. 3

Further Keys

Operating manual



- ESCAPE** Quits popup menus, closes an editor discarding the entries made

👉 Chap. 3



- ON/STANDBY** Switches between operation (green LED) and standby (orange LED)

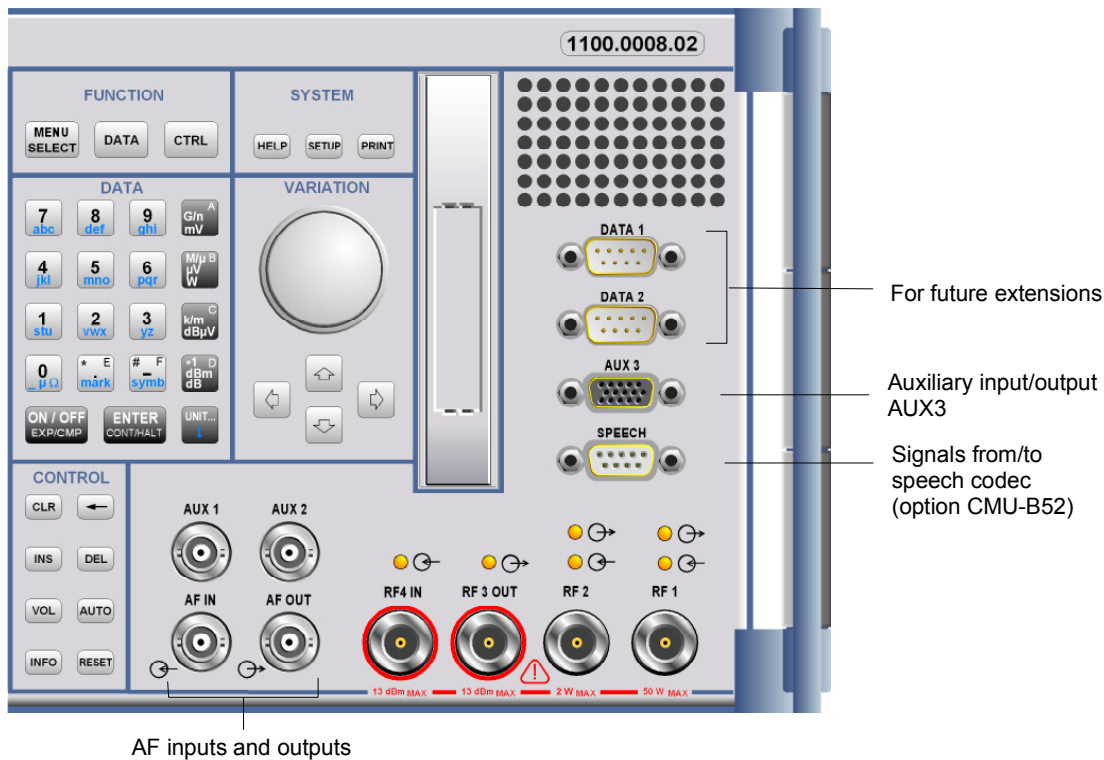
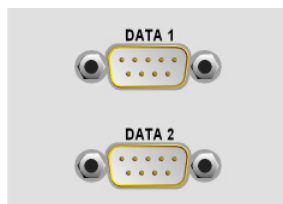

Fig. 1-5 CMU front view connectors

DATA1, DATA2

Operating manual



For future extensions



Chapter 8, "Hardware connectors"

AUX 3 and SPEECH

Operating manual

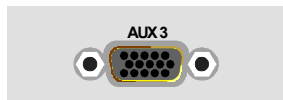

Input and output for status, control, and trigger signals:
CMU 300: External trigger signal for wired synchronization



Chapter 8, "Hardware connectors"

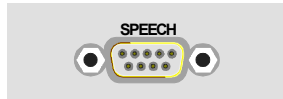

Signals from/to speech codec (option CMU-B52)



Chapter 8, "Hardware connectors"

AF connectors

Operating manual

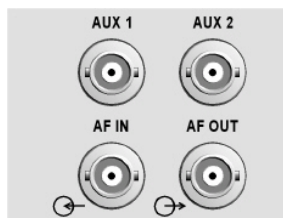

Connectors for audio signals:

AUX1/2 Additional input/output for audio signals that may be used in remote control (secondary audio analyzer)



Chapter 4, "Audio Generator and Analyzer";

AF IN/OUT Standard input/output for the (primary) audio analyzer

Chapter 8, "Hardware connectors"

Caution: Note the maximum permissible input levels for all AF connectors according to the data sheet in order to prevent damage to the instrument!

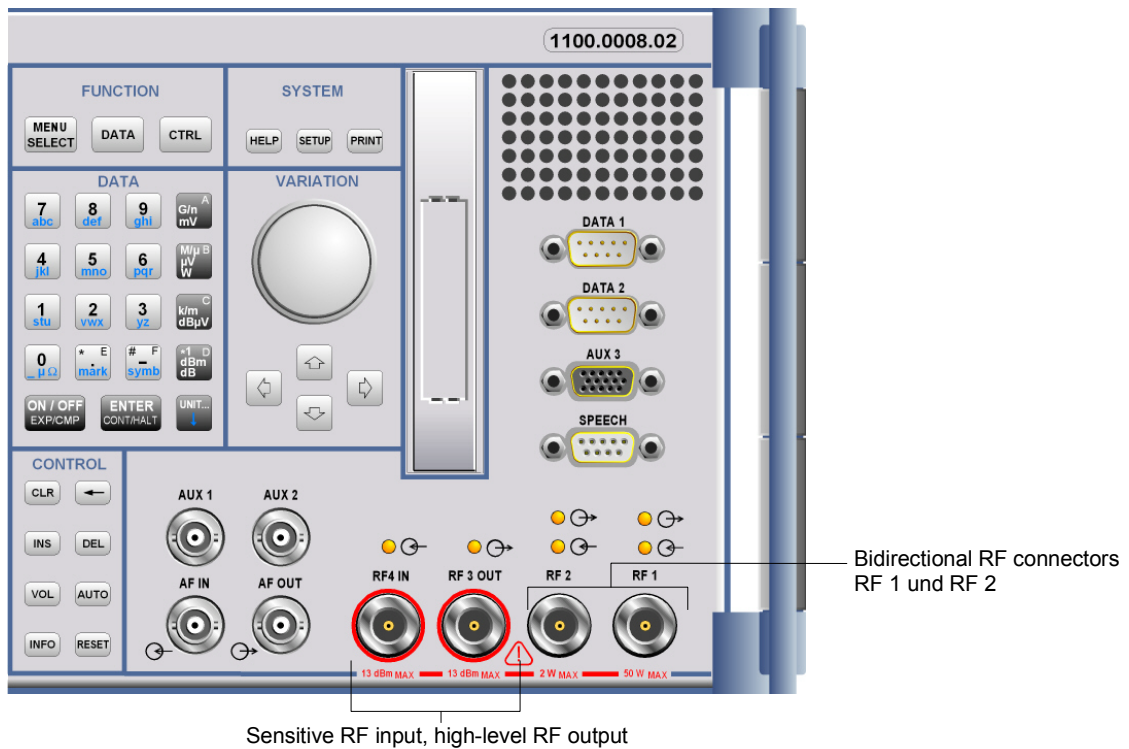
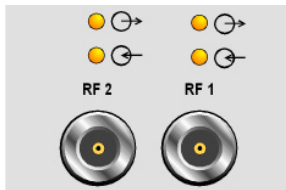

Fig. 1-6 CMU front view– connectors

RF connectors

Operating manual



Bidirectional RF connectors for various power ranges according to the data sheet.

The two LEDs above the connectors are illuminated as long as the CMU sends signals or is ready for reception .



Chapter 8, "Hardware connectors "

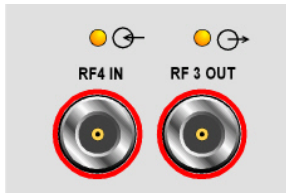

Connector with high output level and connector for sensitive RF measurements (antennas). Power ranges according to the data sheet. Maximum permissible input and output level according to the label on the front panel.

The two LEDs above the connectors are illuminated as long as the CMU sends signals or is ready for reception .



Chapter 8, "Hardware connectors"



Caution:

Note the maximum permissible input levels for all RF connectors according to the label on the front panel or the data sheet in order to prevent damage to the instrument!
RF connectors may warm up very much when high RF power is fed in!



Fig. 1-7 CMU front view – Compact Flash card slot

Compact Flash (CF) Card Slot

Operating manual



CF or PCMCIA card reader.

- PCMCIA slots are available on instruments equipped with a front module controller version FMR6 or earlier. These instruments also support an alternative floppy disk drive (option R&S CMU-U61).
- CF card slots are installed on instruments equipped with a front module controller version FMR7.

Chap. 1
Chap. 4

Front module controller version FMR7 provides a larger RAM size. This can speed up measurements because it avoids swapping of software modules.

Note: *The CF card must be inserted in the slot **before** the R&S CMU is started. To be read by the R&S CMU, CF cards must support the True IDE mode.*

Attention! Risk of CF slot malfunctions



To avoid EMC problems and ensure failure-free operation, do not place external cables close to the compact flash card .

If the CF card is temporarily removed while the R&S CMU is switched on, the screen may freeze for a few seconds, and instrument may not be able to read the card any more (error message "Drive is not ready").

Always switch R&S CMU to standby mode before removing the CF card. To cure the symptoms described above, power off the instrument and then power it on again.

Rear View

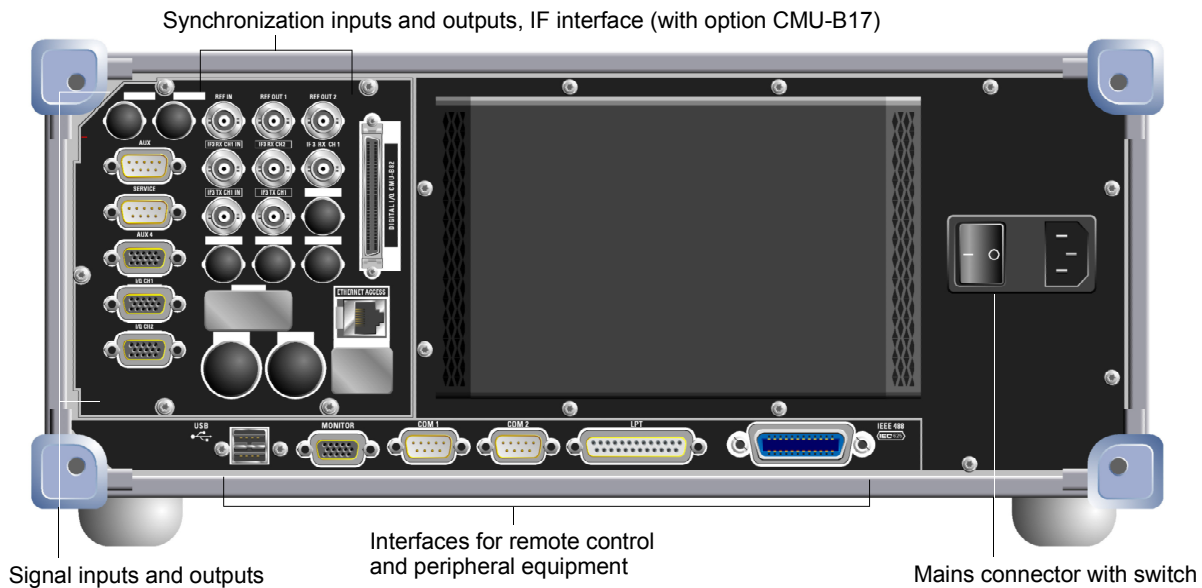
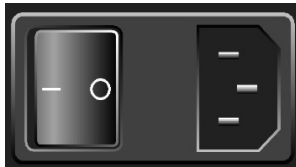

Fig. 1-7 CMU rear view

Mains switch

Operating manual



Mains power switch



Chapter 1, "Switching on the Instrument, Startup test"

Mains connector



Chapter 1, "Connecting the instrument to the AC supply"

Interfaces

Operating manual

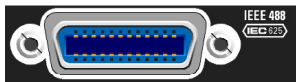

GPIB-bus connector (IEEE 488 / IEC 625),



Chapter 8, "Hardware Interfaces "

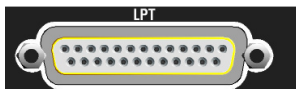

Parallel interface: 25-contact printer connector, Centronics-compatible



Chapt. 1, "Connecting an Output Device" Chapter 8, "Hardware Interfaces"



Connector for serial interface 1: 9-contact Sub-D connector



Chapter 8, "Hardware Interfaces"



Connector for serial interface 2: 9-contact Sub-D connector



Chapter 8, "Hardware Interfaces"

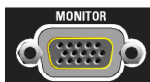

Connector for an external VGA monitor: 15-contact Sub-D connector



Chapter 1, "Connecting a Monitor" Chapter 8, "Hardware Interfaces"



USB connector for external keyboard only (not for other pointing or storage devices)



Chapter 1, "Connecting an External Keyboard" Chapter 8, "Hardware Interfaces"

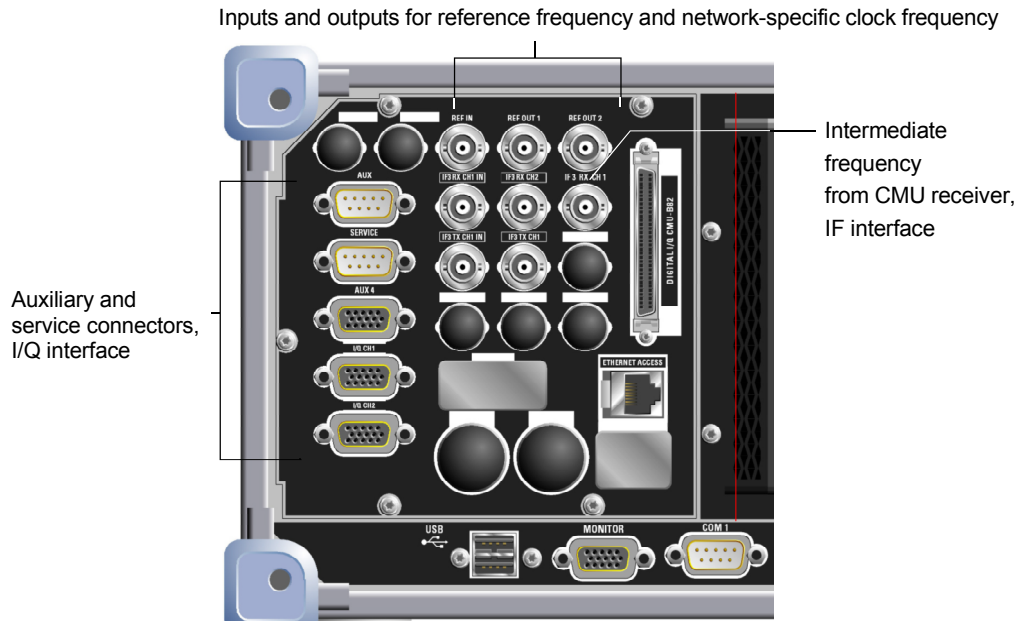

Fig. 1-8 CMU rear view – signal inputs and outputs

Intermediate frequency Operating manual



IF3 RX CH 1 (BNC connector) from CMU receiver



Chapter 8, "Hardware Connectors"

Reference frequency Operating manual



REF IN Input for external reference frequency



Chapter 8, "Hardware Connectors"

REF OUT 1 Output of reference frequency of CMU: 10 MHz or the signal of input REF IN

REF OUT 2 Output for network-specific clock frequency



Chapter 3, "RF Connection Control"



Caution!

Do not use open or unshielded cables in order to comply with EMC directives!

AUX, SERVICE, AUX4, extensions Operating manual

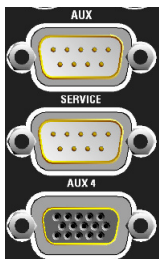

Two 9-contact and one 15-contact SUB-D connectors:



Chapter 8, "Hardware Connectors"

AUX Auxiliary connector providing a DC voltage to supply external equipment such as CMU-Z6

SERVICE Service connector for RXTX board (only for internal test purposes)

AUX4 Bidirectional input/output for digital status, control, and trigger signal

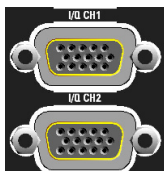

The remaining 15-contact SUB-D connectors are reserved for future extensions.



Chapter 8, "Hardware Connectors"

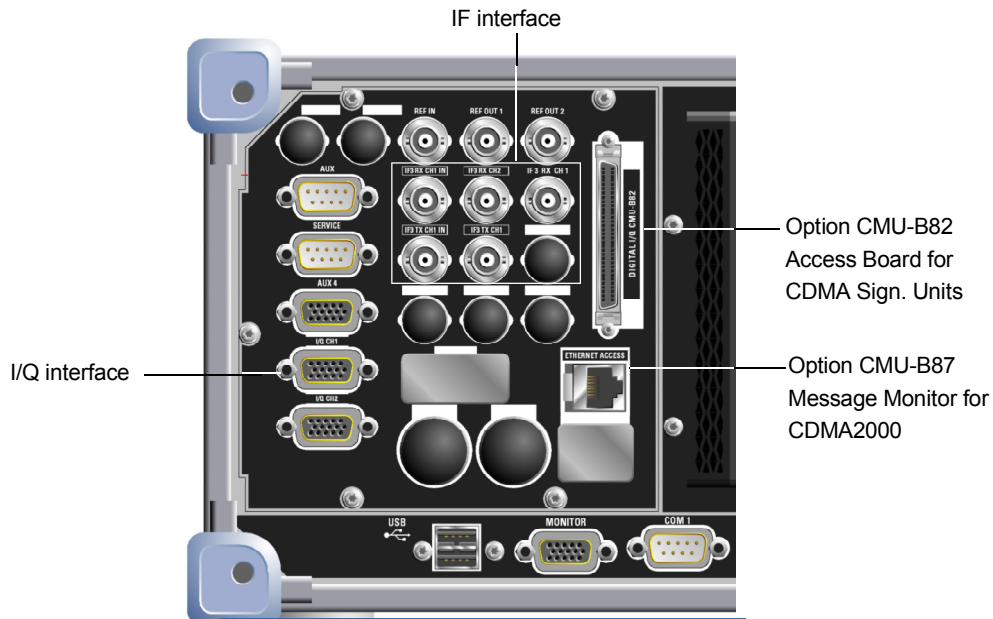
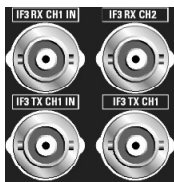

Fig. 1-9 CMU rear view – I/Q-IF inputs and outputs

I/Q-IF Interface (CMU 200 with option CMU-B17) Operating manual



Four 50 Ω BNC connectors for option CMU-B17, I/Q and IF Interface:

- IF3 RX CH1 IN RX path, IF IN
- IF3 RX CH1 OUT RX path, IF OUT
- IF3 TX CH1 IN TX path, IF IN
- IF3 TX CH1 OUT TX path, IF OUT

Chapter 4, "Hardware Connectors"
Chapter 8, "Hardware Connectors"



15-contact SUB-D connector for input and output of I/Q signals (option CMU-B17, I/Q and IF Interface)

The SUB-D connector below IQ CH 1 is not used.

Chapter 8, "Hardware Connectors"

Optional interfaces for data applications (CMU 200)



Digital I/Q connector for option R&S CMU-B82, Access Board for CDMA Signalling Units

Installation instructions for options



Ethernet connector e.g. for option R&S CMU-B87, Message Monitor for CDMA2000

An additional Ethernet connector can be fitted below, e.g. for option R&S CMU-Z46, WCDMA Message Analyzer and Recorder.

Installation instructions for options

Note: Some options require additional rear panel connectors. E.g. the Abis connectors for R&S CMU 300 with option R&S CMU-B71 are described in Chapter 8 of this operating manual and in the CMU 300 Quick Start Guide.

Putting the Instrument into Operation

This section describes the basic steps to be taken when setting up the R&S CMU for the first time.



Caution!

Please make sure to observe the instructions of the following sections so that you cannot cause damage to the instrument or endanger people. This is of particular importance when you use the instrument for the first time.

Please also observe the general safety instructions at the beginning of this manual.

Unpacking the Instrument

When receiving your instrument, first perform the following steps.

1. Remove the instrument from its packaging and check the equipment for completeness using the delivery note and the accessory lists for the various items.
2. First, pull off the polyethylene protection pads from the instrument's rear feet and then carefully remove the pads from the instrument handles at the front.
3. Pull off the corrugated cardboard cover that protects the rear of the instrument.
4. Carefully unthread the corrugated cardboard cover at the front that protects the instrument handles and remove it.
5. Check the instrument for any damage. If there is damage, immediately contact the carrier who delivered the instrument. In this case, make sure not to discard the box and packing material.

It is advisable to keep the original packing material in order to prevent control elements and connectors from being damaged in case the instrument is to be transported or shipped at a later date.

Setting up the Instrument

The R&S CMU is designed for use under laboratory conditions, either on a bench top or in a rack. The general ambient conditions required at the operating site are as follows:

- The ambient temperature must be in the ranges specified for operation and for compliance with specifications (see data sheet).
- All fan openings including the rear panel perforations must be unobstructed. The distance to the wall should be at least 10 cm.

Notes: *For safe and convenient operation of the instrument note the following:*

- Avoid moisture condensation. If it occurs, the instrument must be wiped dry before switching on.
- Note the warm-up time of the temperature-controlled OCXO reference oscillator (Option CMU-B11/B12), see data sheet.

Bench Top Operation

Permissible operating positions of the R&S CMU:

- Horizontal position, standing on the feet.

- For applications in the laboratory or on a work bench, it is recommended that the support feet on the bottom of the instrument be extended. For the LCD display, this provides the optimum viewing angle which typically ranges from perpendicular to the display front to approximately 30° below.

Warning! Danger of injury



The feet may fold in if they are not folded out completely or if the instrument is shifted. The feet may break if they are overloaded. Fold the feet completely in or completely out to ensure stability of the instrument and personal safety. To avoid injuries, never shift the instrument when its feet are folded out.

The overall load (the instrument's own weight plus that of the instruments stacked on top of it) on the folded-out feet must not exceed 500 N.

Place the instrument on a stable surface. Secure the instruments stacked on top of it against slipping (e.g. by locking their feet on the top front frame).

When the instrument is standing on its folded-out feet, do not work under the instrument and do not put anything under it, otherwise injuries or material damage could occur.

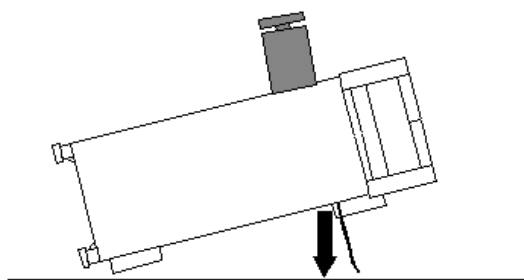

<500N

The instrument can be used in each of the positions shown here.

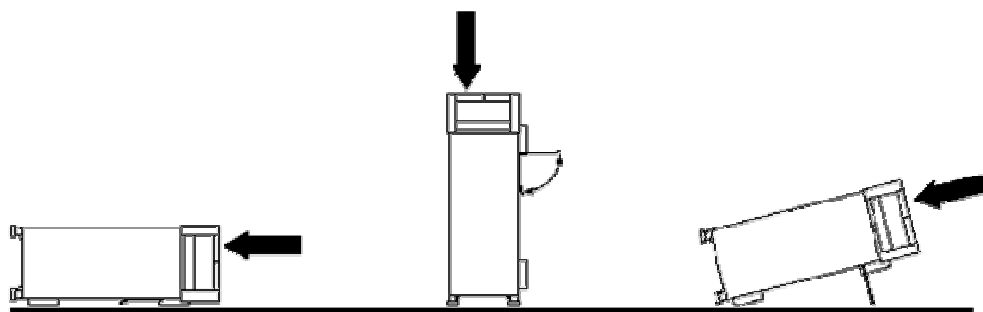

Mounting in a Rack

Using the adapter ZZA-411 (order number 1096.3283.00) the instrument can be mounted in 19" racks according to the mounting instructions supplied with the rack adapter.

Note: For convenient operation of the instrument note the following:

- Allow for sufficient air supply in the rack.
- Make sure that there is sufficient space between the ventilation holes and the rack casing.

Connecting the Instrument to the AC Supply



Caution!

After moisture condensation, allow the instrument to dry before switching on.

Note the permissible ambient temperature according to the data sheet.

Do not cover the lateral and rear ventilation holes.

The CMU may be connected to one-phase AC supplies with nominal voltages ranging from 100 V to 240 V and nominal frequencies ranging from 50 Hz to 400 Hz (see inscription on the rear panel and data sheet). Depending on the options installed, the power consumption ranges from 120 W to 230 W.

Note: *The CMU is automatically adapted to the AC supply voltage applied. External switchover or adaptation of the fuses are not necessary.*

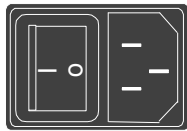

Mains
connector

For the mains connection use the supplied mains connector.

As the instrument is designed according to the regulations for safety class EN61010, it must be connected to a grounded power outlet.

Switching on the Instrument / Startup Test

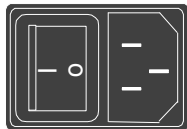

Mains
switch

The CMU can be switched on using the mains switch at the rear of the instrument and the ON/STANDBY key at the bottom left of the instrument front.

The *mains switch* can be set to two positions:

- 0** The 0 position implies an all-pole disconnection of the instrument from the mains.
- I** In the I position, the instrument is in standby mode or in operation, depending on the position of the ON/STANDBY key at the front of the instrument.

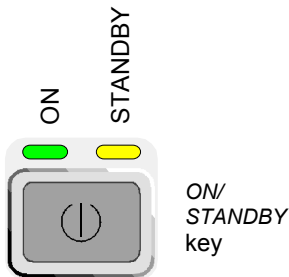

ON/
STANDBY
key

The ON/STANDBY key activates two different operating modes indicated by colored LEDs:

- Standby** Only the OCXO reference frequency oscillator (Option CMU-B11/B12), if installed, is supplied with operating voltage. The orange LED (STANDBY) on the right is illuminated.
- Operation** In this operating mode, all modules of the instrument are supplied with operating voltage. The green LED (ON) on the left is illuminated.

Start procedure

- To switch on the CMU set the mains switch to the position I.

The CMU enters standby mode.

- Set the CMU to operating mode by pressing the ON/STANDBY key once.

Note: *To be read by the R&S CMU, a compact flash card must be inserted in the slot **before** the R&S CMU is started and not be removed during operation. Refer to the description of the CF card slot earlier in this chapter.*

Startup menu

After activation of the operating mode, the startup menu appears for a few seconds. While it is displayed the CMU performs a startup test.

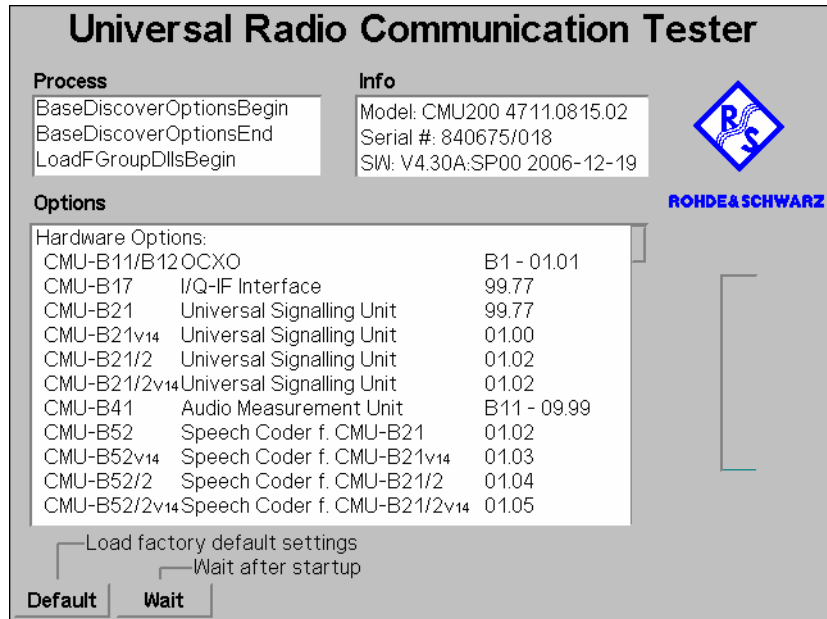

Displays in startup menu

The display windows of the startup menu provide information on

- The startup procedure (*Process*)
- Instrument model, serial number and version of the CMU base software (*Info*).
- Installed hardware and software options and equipment (*Options*). Available software options are listed with their version numbers.
- Progress of the startup procedure (*Startup* bar graph).

After terminating the startup procedure, the instrument changes to the last main menu or graphical measurement menu of the previous session.

Switching off the Instrument

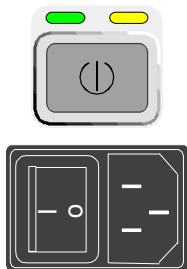

To keep all settings that have been made, proceed in the following order to switch off the CMU:

- **Shortly** press **ON/STANDBY** to initiate the shutdown process and save the current data to the internal hard disk.
- Wait until the shutdown process has been terminated before setting the mains switch at the rear to the 0 position.

In standby mode, it is safe to remove a compact flash card from the card reader. Refer to the description of the CF card slot earlier in this chapter.

Note: *Instruments equipped with a Front Module controller FMR 6 display the message Shutdown in Progress after the ON/STANDBY key has been pressed. Keeping ON/STANDBY pressed for about 4 s on those instruments initiates a hardware shutdown where data may be lost.*

How to Ensure EMC

In order to avoid electromagnetic interference, the instrument may only be operated when it is closed and with all shielding covers fitted.

REF OUT 1 and REF OUT 2: Use double shielded cables and match signal with 50 Ω in order to comply with EMC directives!

Input Level



Caution!

- In order to prevent damage to the instrument note the maximum permissible input levels at the AF inputs AF IN and AUX 1 as well as for the RF inputs RF 1, RF 2 and RF 4 IN at the front of the instrument.

Connecting the CMU to the Test Setup



Warning:

Connect external devices and peripherals only when the instrument is switched off or in STANDBY mode. Otherwise, future errors cannot be excluded.

Connecting a Controller

The CMU can be connected to an external controller via the GPIB bus (IEEE bus according to standard IEEE 488; throughout this documentation we will primarily use the term GPIB bus which is also used in the operating menus and in the SCPI command syntax) or via serial interface:

Connection via GPIB bus

The CMU is connected to the GPIB interface of the controller via the GPIB bus connector (IEEE 488 / IEC 625) at the rear of the instrument and a shielded cable. The technical specifications of the GPIB interface are listed in section "Hardware Interfaces " in Chapter 8.

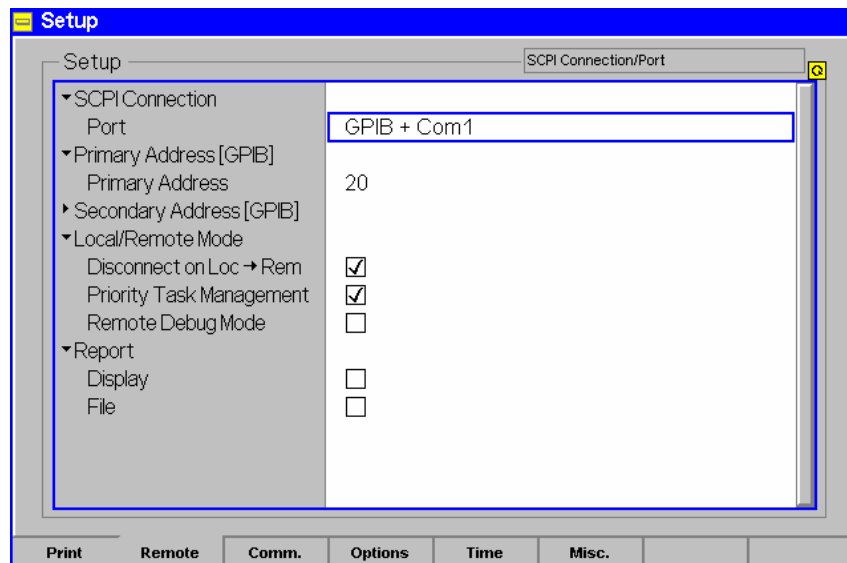
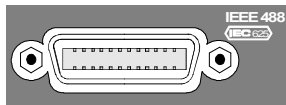

GPIB Bus Configuration

In the default configuration the CMU accepts commands from either the GPIB or COM 1 interface. The parameters for GPIB bus control of the CMU are set in the *Remote* tab of the *Setup* popup menu (in the following abbreviated by *Setup – Remote*, see also chapter 4, *Settings for Remote Control*).

- To open the *Setup - Remote* menu, press the *SETUP* key at the front of the instrument and activate the *Remote* hotkey at the lower edge of the screen.
- Use the rotary knob to move the focus onto the *SCPI Connection* section of the *Setup* table. If necessary, press the rotary knob or the *ON/OFF* key to expand the parameters in the table (see Chapter 3).
- In the *Port* table row select either *GPIB + Com 1* or *GPIB* bus interface for transmission.

The bus address is factory-set to 20. It can be changed in the *Primary Address* input field.

Connection via serial interface

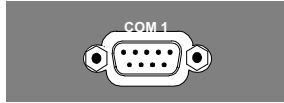

The CMU can be connected to the serial interface of a controller via one of the serial interfaces COM 1 or COM 2 and a so-called null-modem cable. The pin assignment and wiring of a null-modem cable are described in section *Handshake* of chapter 8. The technical specifications of the serial (RS-232-C) interface are also discussed in chapter 8 (refer to section *Hardware Interfaces*).

Either a 25-pin or a 9-pin connector can be used on the controller side. It may be necessary to use an appropriate adapter (see chapter 8, *Hardware Interfaces*).

Selection

In the default configuration the CMU accepts commands from either the GPIB or COM 1 interface. The COM 2 interface must be selected explicitly.

- Proceed as described above to activate the *Remote* tab of the *Setup* menu.
- In the *Port* table row, select *GPIB + Com 1* or *COM 1* or *COM 2* to activate one of the RS-232 interfaces for data transfer.

Configuration

After selection of a serial interface, the transmission parameters must be set to comply with the parameters of the addressed device. This is done in the *Comm.* (*communications*) tab of the *Setup* menu:

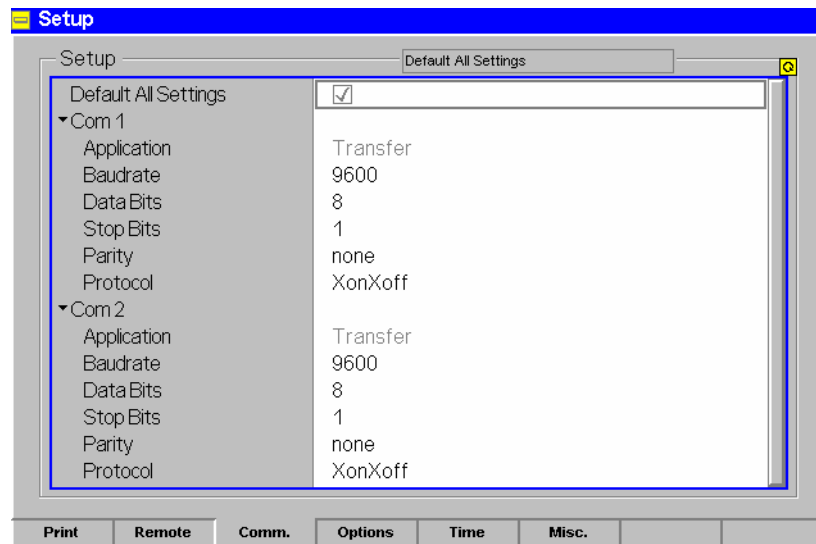

- To open the *Setup – Comm.* tab press the *SETUP* key at the front of the instrument and activate the *Comm.* hotkey at the lower edge of the screen.
- In the table section corresponding to the selected COM port check the settings for the *Baudrate*, *Data Bits*, *Parity*, and *Protocol*.

Connecting an External Keyboard



An external PC keyboard to the CMU can be connected to the USB connector at the rear of the instrument. An external keyboard facilitates the input of numbers and texts.

For the interface description see section "Hardware Interfaces" in chapter 8.

The key assignment can be changed in the *Misc.* tab of the *Setup* menu:

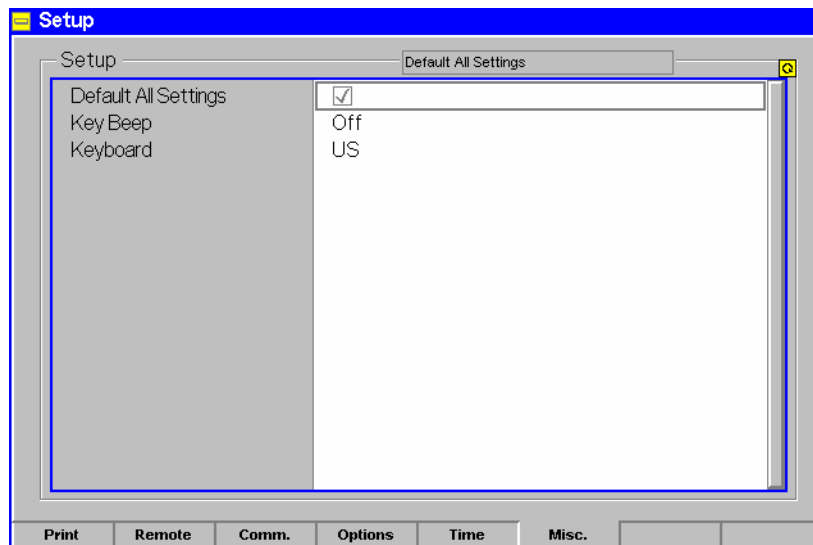

- Language assignment**
- To open the *Setup – Misc.* tab press the *SETUP* key at the front of the instrument and activate the *Misc.* hotkey at the lower edge of the screen.
 - Use the rotary knob to select *Keyboard* and set the desired language (*US* or *German*).

Connecting a Monitor

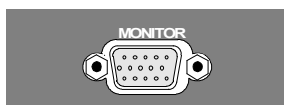

An external VGA monitor can be connected to the 15-contact Sub-D connector at the rear of the instrument.

For the interface description see section "Hardware Interfaces" in chapter 8.

Connecting a Printer

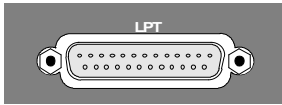

A printer can be connected via the 25-contact parallel interface *LPT* at the rear of the instrument (recommended) or one of the serial interfaces COM 1 or COM 2. For the interface description see section "Hardware Interfaces" in chapter 8.

The printer type and port must be set in the *Print* tab of the *Setup* menu:

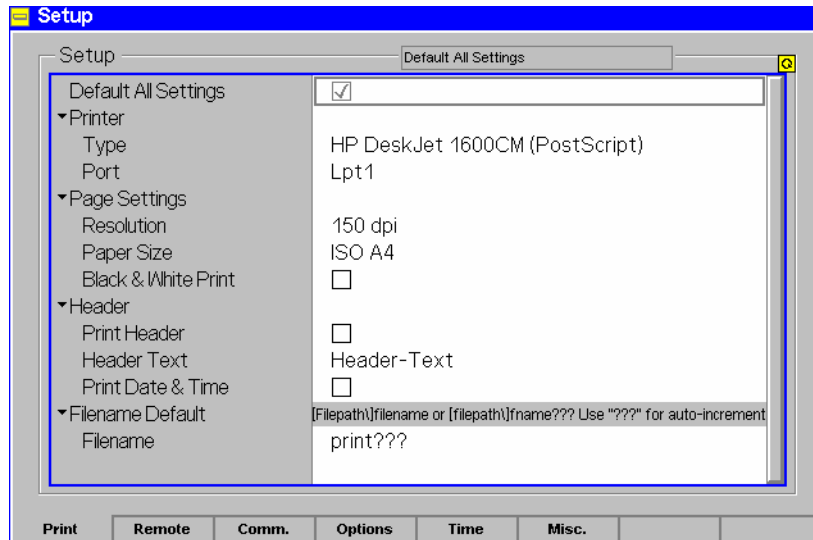

- To open the *Setup – Print* tab press the *SETUP* key at the front of the instrument and activate the *Print* hotkey at the lower edge of the screen.
- In the *Printer* section set the printer type and port (*COM 1* or *COM 2* for the serial (RS-232) ports; *LPT 1* for the parallel printer port).

It is recommended to connect the output device to the parallel interface *LPT*, if possible: With this selection, configuration of the interface is not necessary; besides, the serial connectors may be used for GPIB bus etc.

Synchronization with External Devices; Connection of Further Components

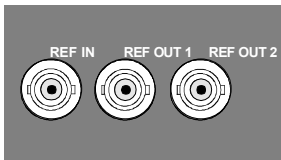

The three BNC female connectors REF IN, REF OUT 1, REF OUT 2 are provided for synchronization of the CMU with external devices.

Software Update and Version Management

Your CMU was delivered with the latest software and firmware version available. New firmware can be easily installed via the CF card / PCMCIA slot or floppy disk drive (option CMU-U61) on the front of the instrument.

Note: *When copying an installation version to a CF / PCMCIA card or floppy, ensure that all folders containing a base system version or network option (the lowest-level folders in Fig. 1-9 below) are in the root directory. Otherwise the CMU will not be able to detect the firmware and start the installation. If a Versions.new text file (see section [File Versions.new](#) on p. 1.28 ff.) is used, it must also be in the root directory of the external storage medium.*

New software options must be enabled by means of a key code entered in the Setup – Options menu (see chapter 4). This is necessary only once; all options remain enabled after a software update.

Installation of new firmware versions and the use of different applications and versions on the same instrument is made easier by the following tools:

- The R&S *Remote Service Tool* (see p. 1.20 ff.) transfers software versions to the instrument.
- The *VersionManager* (see p. 1.29 ff.) is designed to manage different software versions stored on the instrument.

Installation instructions are also given in Chapter 1 of the operating manuals for the individual software options.

Is not required to perform a recalibration of the R&S CMU200/300 after a software upgrade or downgrade. To ensure that the R&S CMU TX and RX is working according to the specification after a software change the following tests are performed during the type approval of every new software release:

Test 1:

- Adjustment (measurement of correction values) and verification with the latest official software.
- Upgrade to the new software and verification.

Test 2:

- Adjustment and verification with the new software.
- Downgrade to the latest official software and verification.

The tests are passed if all verification results show comparable values. Rohde & Schwarz is certified according to ISO 9001 since May 1995.

R&S Remote Service Tool

The R&S Remote Service Tool organizes the exchange of data between the R&S CMU and an external PC or laptop, in particular to:

- Copy software versions and install them on the R&S CMU.
- Copy or move data files (e.g. screenshots created with the Print menu of model R&S CMU).
- Send remote control commands to the instrument.

The tool is available for download on the CMU Customer Web (<https://gloris.rohde-schwarz.com/gloris/1cmp/cmucustomer/index.html>). It consists of a single *.exe file which can be copied to any directory. When the executable file is started (double-clicked), the R&S Remote Service Tool opens the following main application window.

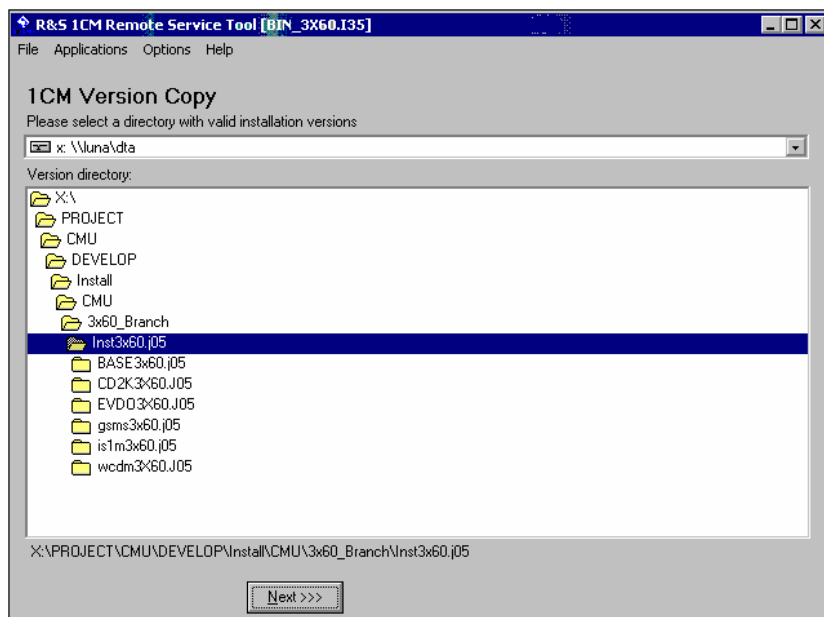

Fig. 1-9 Remote Service Tool main screen (example)

Connecting the R&S CMU

The R&S Remote Service Tool can communicate with the R&S CMU via the GPIB (IEEE 488) or a RS-232 interface. To ensure fast transmission, it is recommended to use the GPIB interface, connecting the GPIB cable to the *IEEE 488 / IEC 625* connector on the rear panel of the instrument.

Note: *The GPIB settings of the Remote Service Tool and of the R&S CMU must be the same. Refer to section [Connecting a Controller](#) on p. 1.16 to learn how to configure the R&S CMU's GPIB settings.*

6. Connect the GPIB cable to the *IEEE 488 / IEC 625* connector on the rear panel of the instrument.
7. Start the *Remote Service Tool*.
8. Click the *Options* menu and make sure that *Use GPIB* is selected.
9. Click *Options – GPIB Options* and check that the *Board Index* and *Primary Address* settings are equal to the R&S CMU configuration (CMU default settings: board index GPIB0, primary address 20).

Installing software versions

To copy a new software version to the CMU...

1. Switch on and start up your R&S CMU.
2. Select *Applications – Version Copy* from the menu bar of the *Remote Service Tool*.
3. In the *Version directory* of the main application window, select the folder from where you want to copy your software version and click *Next >>>*.

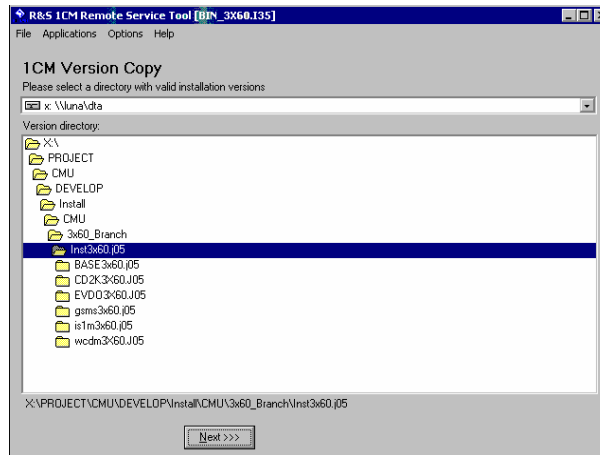

4. Select the software version you wish to install and click *Start >>>*.

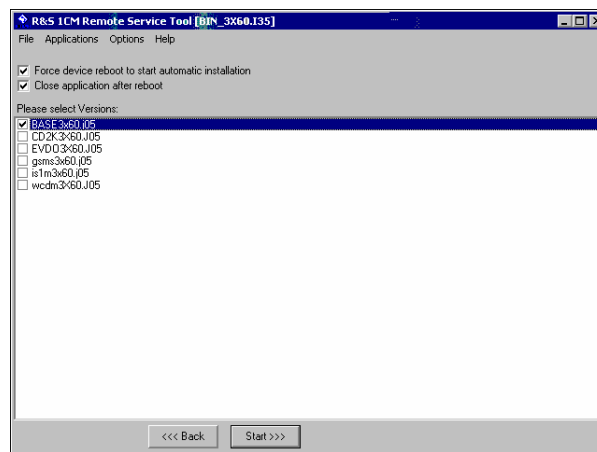

The software version is copied to the internal drive `C:\INTERNAL\INSTALL` of your R&S CMU. In addition, a text file named *Versions.new* (see section [File Versions.new](#) on p. 1.28 ff.) is generated and copied to the same directory. With default installation options (see figure above), the following happens after the file transfer is completed:

- The CMU is rebooted and the new software version is installed and activated (a key code must be entered once when a new software package is installed; see section *Hardware and Software Options* in chapter 4).
- The *Remote Service Tool* is closed automatically.

Old software versions are not affected. You can delete or activate an old software version using the *VersionManager* (see p. 1.29 ff.).

Note: *You can also copy a software version to the internal hard disk and use the *VersionManager* for the installation.*

Listing and modifying software versions

The *Remote Service Tool* can not only install firmware versions but also display and modify the installed firmware configurations.

To list the firmware configurations installed on your CMU...

- Click Application – List Software.

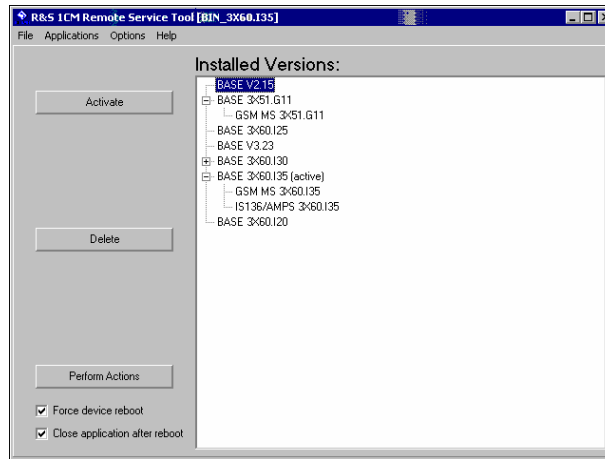

The list of installed versions has a tree structure. Each expandable node  contains a software configuration consisting of one base system version and one or more network options. The active configuration is marked as *(active)* and also displayed in the title bar of the *Remote Service Tool*. You can use the controls on the left side to do the following:

- Select a configuration in the list and click *Activate* to label the configuration active.
- Select a configuration in the list which is not the active configuration and click *Delete* to label the configuration deleted. Repeat this for all configurations you wish to delete.

Labeled configurations are not deleted immediately. You can simply *Restore* any configuration that you labeled inadvertently.

➤ Click *Perform Actions* to activate and/or delete the labeled configurations.

The labeled configurations are written to the *Versions.new* text file (see section [File Versions.new](#) on p. 1.28 ff.) which is copied to the internal drive *C:\INTERNAL\INSTALL* of your R&S CMU. In the default configuration where *Force device reboot* is enabled, the R&S CMU is rebooted immediately so that the *VersionManager* can activate and delete the labeled configurations.

Tip: *Disable Force device reboot in case you wish to postpone the actions until next time you switch on your instrument.*

Copying files

To transfer a file from the CMU to the PC or vice versa...

1. Switch on and start up your R&S CMU.
2. Select *Applications – File Transfer* from the menu bar of the *Remote Service Tool*.

The main application window shows the directories and files on your PC and on the *INTERNAL* directory of the CMU's hard disk.

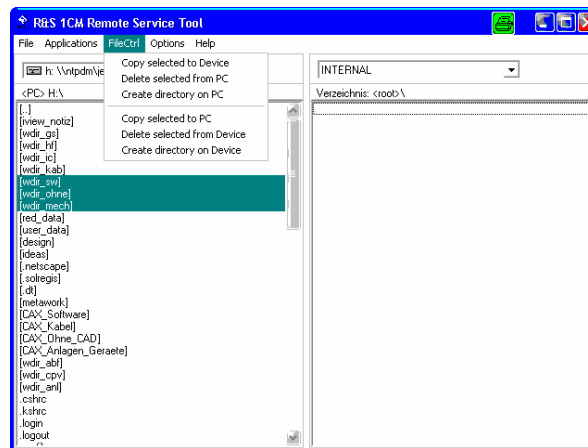

3. Select a directory, a file or several files and use the commands in the *FileCtrl* menu to initiate the file transfer. You can also right-click the file list to open the equivalent context menu.

Extracting screenshots

A screenshot transferred by means of the *Remote Service Tool* can be viewed and copied to the clipboard so that you can use it in another application.

To generate, transfer and further process a screenshot...

1. Press the *PRINT* button on the front panel of the CMU to open the *Print* dialog, select *Internal WMF* as a destination and specify a file name <file>.wmf for the generated image file (without adding a path).
2. Press *OK* to write the file to the *INTERNALUSERDATA\PRINT* directory of the CMU.
3. Proceed as described above to transfer the file <file>.wmf from the CMU to your PC.
4. Double-click the transferred file (alternative: select the file and press *Enter*).

The *Remote Service Tool* acts as a viewer for the file:

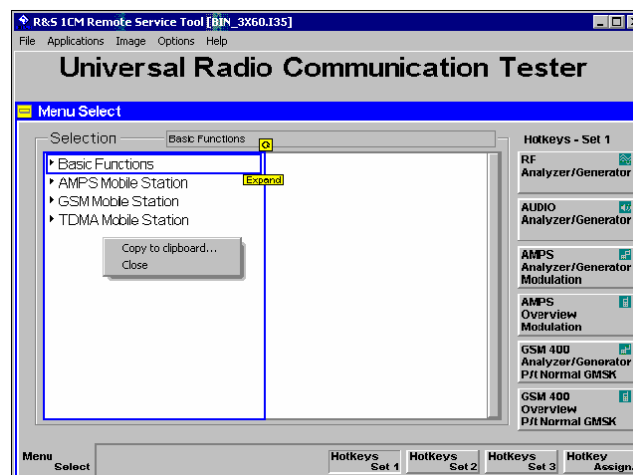

5. Right-click to open a context menu and either copy or close the file.

Remote control of the R&S CMU

You can use the *Remote Service Tool* to transfer remote control commands or command scripts to be executed on the R&S CMU.

To transfer a single command or command sequence...

1. Click *Applications – Command* to activate the remote control screen.

2. Select the appropriate function group in the *Secondary address mapping* panel.
3. Enter a command in the *Enter remote command...* input field and press *Enter*.
4. Repeat steps 2 and 3 for all commands you wish to execute.

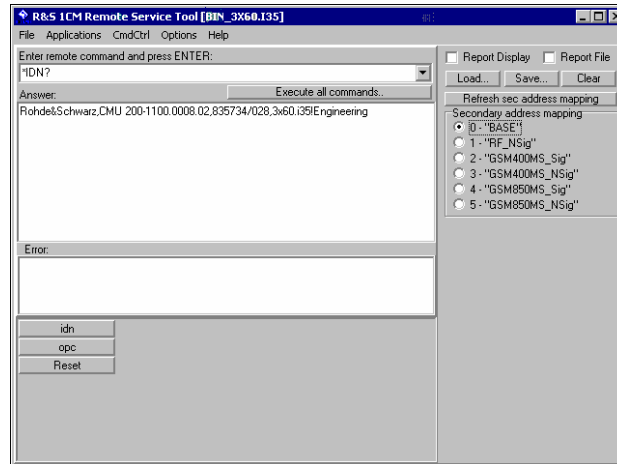

To execute a command script...

5. Generate an ASCII text file of remote control commands, either manually or by saving a previously transferred command sequence (*Save...* button in the remote control screen).
6. In the remote control screen, click *Load...* and open the file.

The script is transferred and executed automatically. The remote control screen provides further control elements to make the command transfer more convenient; see section [Remote Control of the R&S CMU](#) on p. 1.27 ff.

Table 1 Overview of R&S Remote Service Tool functions

| Menu | Command | Function |
|--------------------|---------------|--|
| File | Close | Close the Remote Service Tool. |
| Application | Version Copy | Copy a software version to the R&S CMU. See the application example <i>Installing software versions</i> above. |
| | List Software | Display of all software configurations installed on the R&S CMU and activate and/or delete configurations. See the application example <i>Listing and modifying software versions</i> above. |
| | Command | Transfer of remote control commands or command scripts to be executed on the R&S CMU. This command activates an additional <i>Cmd Ctrl</i> menu to generate log files and customize the screen. See application example <i>Transferring remote control commands</i> above and section Remote Control of the R&S CMU on p. 1.27 ff. |
| | File Transfer | Transfer of data between a PC and the R&S CMU. This command activates an additional <i>FileCtrl</i> menu to create directories, copy or delete files. See application examples <i>Copying files</i> and <i>Extracting screenshots</i> above. |
| | Error Reports | For future extensions |

| Menu | Command | Function |
|----------------|---------------|--|
| Options | Use GPIB | Use the GPIB bus for communication with the R&S CMU. Note: This communication mode is recommended. |
| | USE RS232 | Use the RS232 bus for communication with the R&S CMU. Note: Use the <i>RS 232 Options</i> quoted below if you choose this communication mode. |
| | GPIB Options | Change GPIB connection parameters. The default settings for the R&S CMU are: Board Index: 0 Primary Address: 20 Note: The GPIB settings of the Remote Service Tool and of the R&S CMU must be the same. Refer to section Connecting a Controller on p. 1.16 to learn how to configure the R&S CMU's GPIB settings. |
| | RS232 Options | Change RS232 transmission parameters. The following settings ensure a reliable connection: Baud Rate: 115200 Data Bits: 8 Stop Bits: 1 Parity: None Protocol: CtsRts (do not change!) Note: The RS232 settings of the Remote Service Tool and of the R&S CMU must be the same. Refer to section Connecting a Controller on p. 1.16 to learn how to configure the R&S CMU's RS232 settings. Should you experience any problems with the data transfer, first check and possibly exchange the connecting cable. |
| | Device Clear | Clear the screen. |
| | Go to Local | Exit remote control mode and return to manual operation. |
| | Device Reboot | Reboot the R&S CMU. |
| Help | About | Shows an information box with the current version of the Remote Service Tool. |

Remote Control of the R&S CMU

The remote control screen transfers remote control commands or command scripts to be executed on the R&S CMU; see application example [Remote control of the R&S CMU](#) on p. 1.24. It is opened by clicking *Application – Command*.

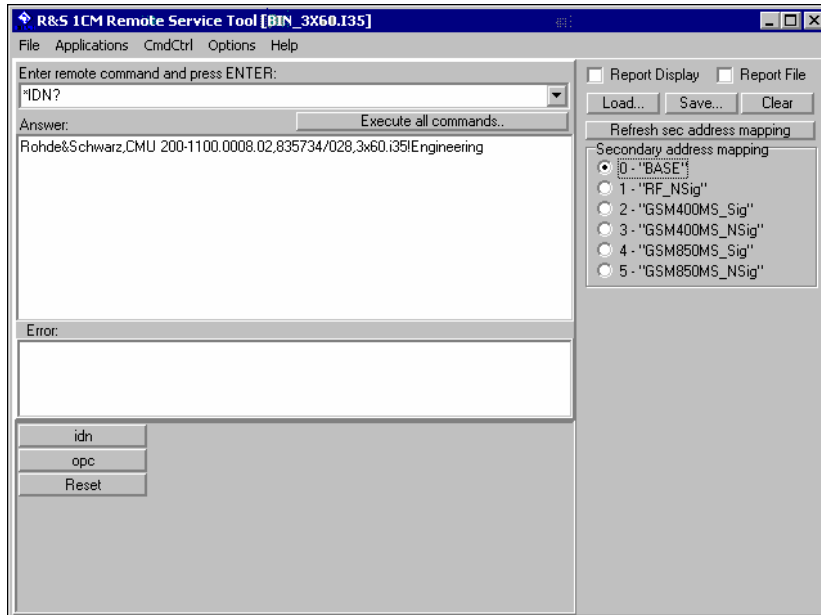

Fig. 1-10 Remote control screen

The commands to be executed are entered in the *Enter remote command...* input field; the responses of the R&S CMU and possible error messages are displayed below. Besides the remote control screen provides the following control elements:

| | |
|-------------------------------------|--|
| Execute all commands | Execute all commands entered since the <i>Remote Service Tool</i> was started or since the list was cleared. The complete command list appears in a pull-down list associated with the <i>Enter remote command...</i> input field. |
| Report Display / Report File | Display the remote report on the R&S CMU's remote screen and create a report file. These functions are identical with the <i>Report Display</i> and <i>Report File</i> hotkeys in the CMU's remote screen. |
| Load / Save | Load an ASCII text file (default extension: *.lst, can be changed at will), with a command script to be executed or save the current command list to a text file. |
| Clear | Clear the current command list. |
| Refresh sec. address mapping | Refresh the list of assigned secondary addresses and function groups, e.g. after the mapping was changed on the R&S CMU. Commands are sent to the secondary address selected in the list. |

While the remote control screen is active, an additional *Cmd Ctrl* menu is available:

Table 2 Overview of Cmd Ctrl menu in the Remote Service Tool

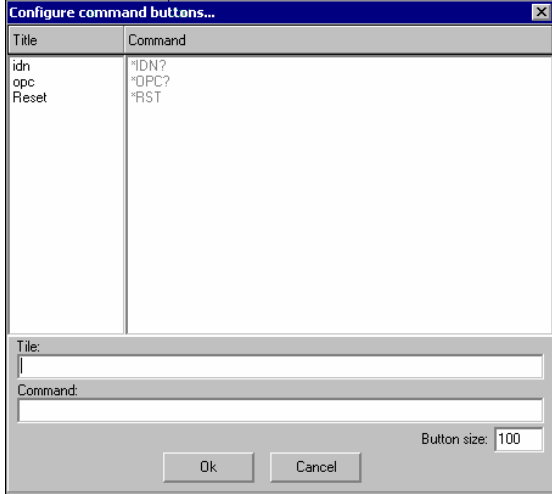
| Command | Function |
|--------------|--|
| Filename... | Call up an <i>Open File</i> dialog to define the name and location of a log file containing all executed commands and device responses. The responses can be up to 2 MByte in size, so the log file information is often more complete than the remote report displayed on the instrument's remote screen. |
| Logging | Toggle function: Enable or disable logging. |
| Append File | Toggle function: If enabled, new information is appended at the end of the log file. Otherwise the log file is overwritten at the beginning of each <i>Remote Service Tool</i> session. |
| Button Setup | Open a dialog to create command buttons, to be used as shortcuts for manual entry of frequently used commands. The command buttons <i>idn</i> , <i>opc</i> , and <i>Reset</i> in Fig. 1-10 on p. 1.27 are created as follows:  |

File *Versions.new*

The *Versions.new* file stores the software configurations that the R&S CMU *VersionManager* has to install, delete, or activate. The following *Versions.new* file initiates the installation of a software configuration containing a base system, a GSM network option package, and a IS136 package:

```

BASE3x60.i35
GSMS3x60.i35
IS1M3x60.i35
Automatic Install
    
```

Creating a *Versions.new* file

The file is most conveniently created using the *Remote Service Tool*; see application examples [Installing software versions](#) on p. 1.21 and [Listing and modifying software versions](#) on p. 1.22. The *Remote Service Tool* also copies the file to its location on the CMU's internal hard disk (*C:\INTERNAL\INSTALL*) so that it will be executed when the *VersionManager* is started.

Alternatively, the file can be created manually and copied to the *C:\INTERNAL\INSTALL* directory or to the root directory of an external storage medium

Restrictions

The information in the *Versions.new* file must be unambiguous: Only one software configuration with 1 base system software can be installed at once.

Alternatively, the file may list several network options to be combined with an already installed, compatible base system version.

Only one software configuration can be active, however, several configurations can be deleted together. To avoid errors, it is recommended to use different files for installation and deletion/activation.

- Typical application** ➤ Copy a *Versions.new* file to the root directory of a CF / PCMCIA card containing several installation versions and insert the card into the R&S CMU's card slot.

After the instrument is booted, the *VersionManager* is started automatically and installs the software packages listed in the file.

CMU VersionManager

The *VersionManager* is a tool designed to activate, delete, install, combine, or list different software versions in a convenient way. Moreover, it provides information on the hardware and software configuration of the instrument (*Edit service tables*, *Scan disk*), resets the startup settings stored in the *non volatile ram*, copies information to an external storage medium (*Write log files to disk*, *List all versions to disk*), and loads and activates user correction tables (see section [RF User Correction](#) on p. 1.39 ff.).

The *VersionManager* is part of each CMU firmware version. It is opened automatically after the boot-up process if the CMU detects a storage medium in its floppy disk drive/card reader that contains an installation version of the CMU firmware. Alternatively, it can be called up by pressing the *Menu Select* key after the boot-up sequence is terminated (from the moment when the CMU display turns black until the end of the 3-beep acoustic signal).

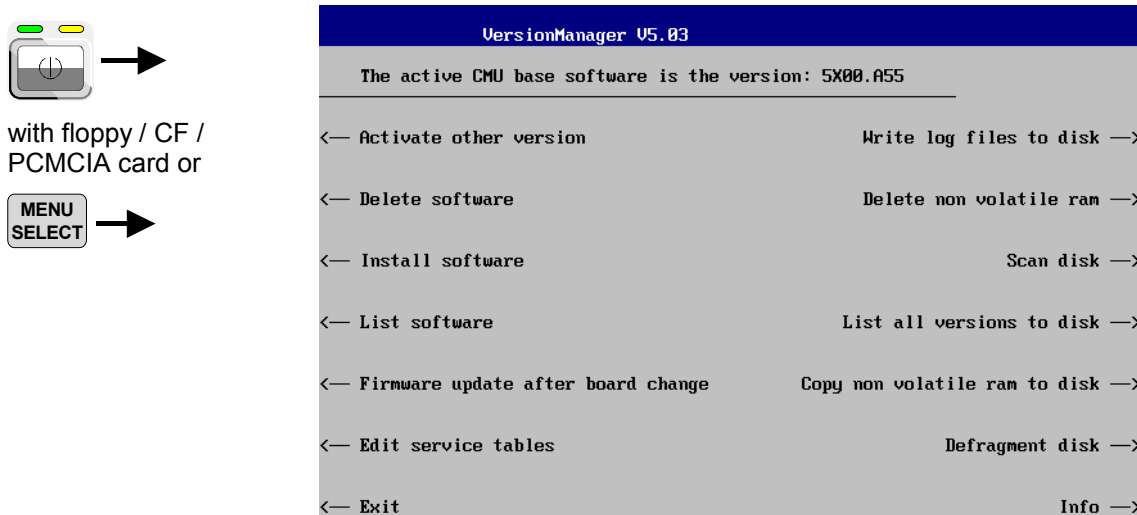
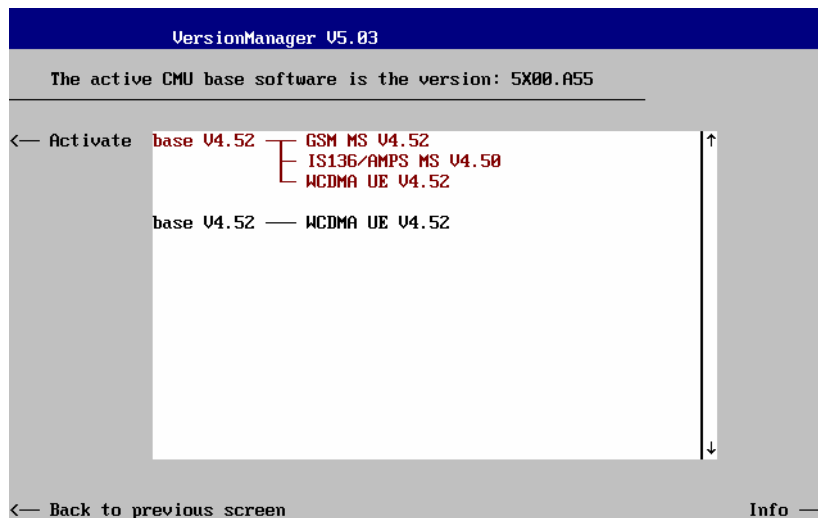

Fig. 1-9 VersionManager main screen (example)

The different functions of the *VersionManager* are activated by pressing the corresponding softkeys. Some of them (labeled optional below) are available in a particular configuration of the hard disk only. The upper two softkeys in both softkey bars are not assigned.

- Activate other version (optional)** *Activate other version* opens a list of all firmware configurations stored on the CMU hard disk except the current configuration. Therefore, this function is not available if the hard disk contains only a single configuration (to retrieve information, *List software* can be used instead).



Each entry in the list corresponds to a firmware configuration consisting of exactly one CMU base software version (top level on the left side) plus a set of associated options¹ (network tests, second level). The version to be activated is displayed in red color on top of the list. To select another version, the list can be scrolled using the rotary knob or the cursor keys.

- Activate** Activate the current firmware configuration.
- Back to previous screen** Close the current screen and go back to the main screen. This option is identical in all *VersionManager* submenus.
- Info** Open the *Info* screen associated with the current screen; see *Info* on p. 1.37. This option is identical in all *VersionManager* submenus.

Delete software (optional)

Delete software opens a list of all firmware configurations stored on the CMU hard disk. The dialog can be operated as explained above; see *Activate software*. The last firmware configuration can not be deleted, so this function is not available if the hard disk contains only a single configuration.

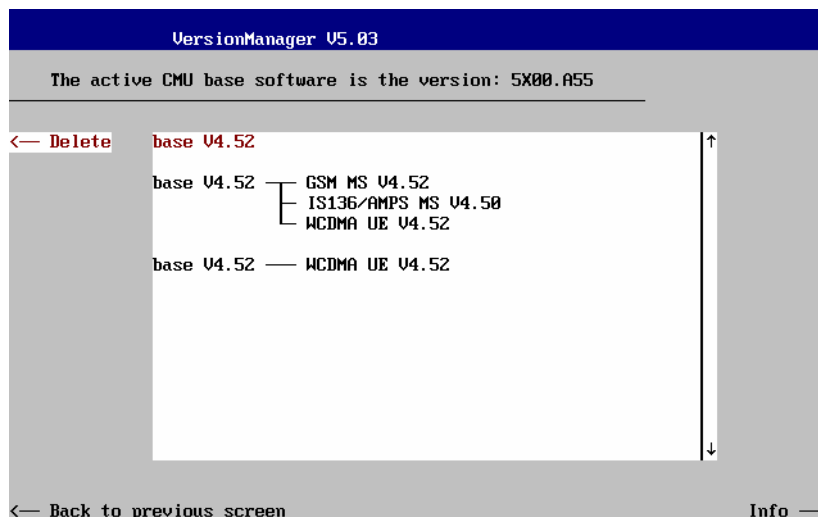

- Delete** Delete the current firmware configuration.

¹ Several related options may be displayed in a single line. These combinations of options can be installed together and will be simply referred to as "options" through the remainder of this section.

If the active firmware configuration is deleted, the CMU asks which of the remaining versions shall be activated:

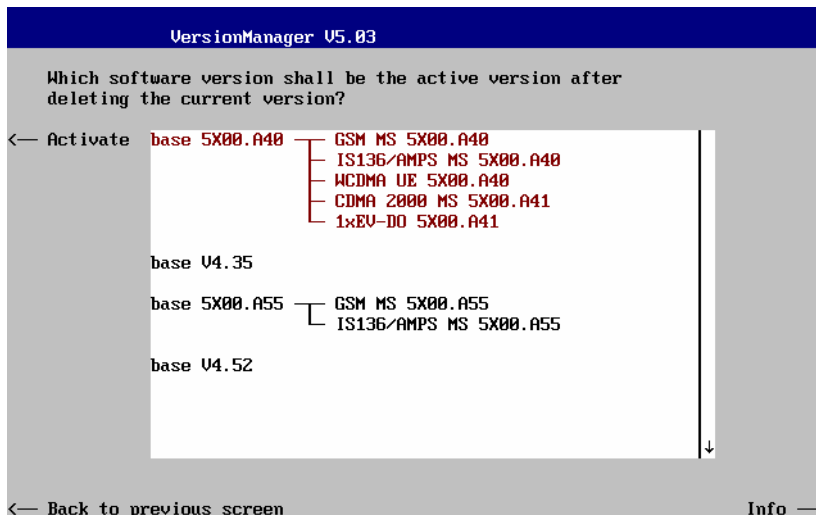

Activate Activate the current firmware configuration.

Install software

Install software opens a list of all firmware installation versions available on an internal or external storage medium that is accessible from the R&S CMU (floppy disk, CF or PCMCIA card). As explained in [Table 1-3](#), this function depends on the type and number of storage media and on the number of installation versions available.

Table 1-3 Software installation with the *VersionManager*

| Storage medium with FW installation version ² | Number of FW installation versions | VersionManager function |
|--|------------------------------------|---|
| Floppy | 1 | <i>Install software version <version> from floppy</i> |
| | several | <i>Install software from floppy</i> → Open software version selection dialog (see below). |
| CF / PCMCIA card in slot 0 or 1 (right or left side) | 1 | <i>Install software version <version> from PC-card slot <slot_no></i> |
| | several | <i>Install software from PC-card slot <slot_no></i> → Open software version selection dialog (see below). |
| CF / PCMCIA card in slot 0 and in slot 1 | 1 (per PC-card) | <i>Install software version <version> from PC-card</i> → Open PC-card selection dialog (see below). |
| | several | <i>Install software from PC-card</i> → Open PC-card selection dialog (see below). |
| Internal drive | 1 | <i>Install software version <version> from internal drive</i> → Open PC-card selection dialog (see below). |
| | several | <i>Install software from internal drive</i> → Open PC-card selection dialog (see below). |

PC-card The *PC-card* selection dialog selects either CF / PCMCIA card slot 0 (right selection dialog: side) or slot 1 (left side) for installation.

² Media without FW installation versions are ignored.

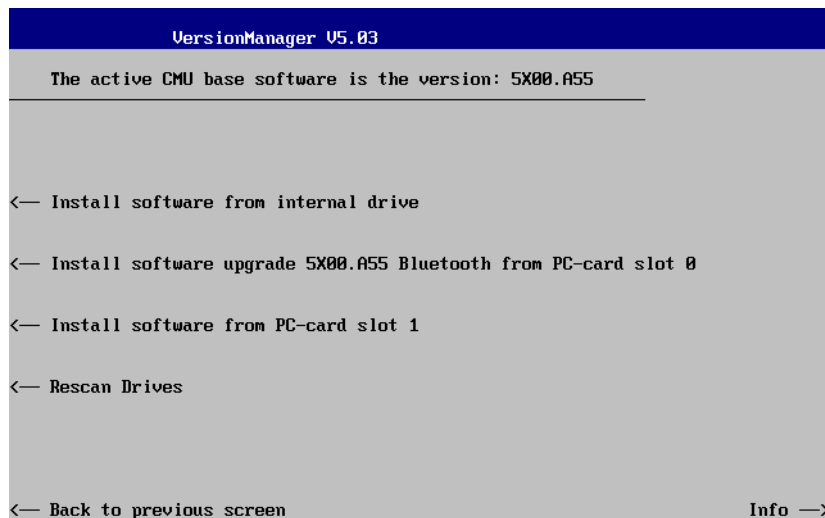

Install software... Select the card in slot 0 or slot 1 as an installation medium. If the medium contains several installation versions, the *software version* selection dialog is called up, see below.

Rescan Drives... Rescans the external and internal drives in order to detect new software installation versions and update the screen accordingly.

Software version selection dialog: The *software version* selection dialog lists all installation versions on the current medium (floppy, CF / PCMCIA card). The dialog can be operated as explained above; see *Activate software*.

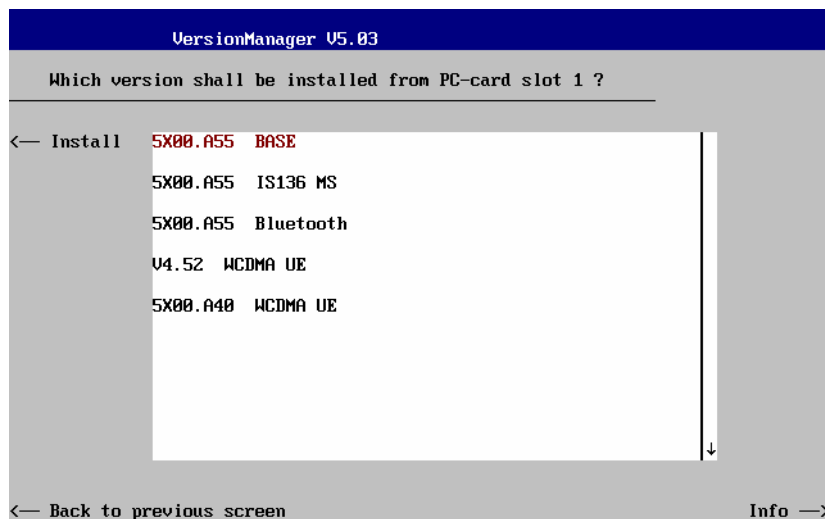

Install Install the current firmware version.

Upgrade options: In contrast to the *Activate software* dialog, the software selection dialog handles base software versions and network options separately. As a consequence, different versions of the base software can be combined with different options to create new firmware configurations. For example, it is possible to update the base software without affecting the associated network options or vice versa. Moreover, the same base software version can be installed several times and combined with different network options (and vice versa), so it may enter into several firmware configurations. The

following simple rules apply:

- With a new version of a network option, it is only possible to update one of the existing configurations. The following selection dialog is automatically skipped.
- With a new base software version, it is possible to either update an existing configuration or create a new one. A dialog selecting between the two alternatives is opened:

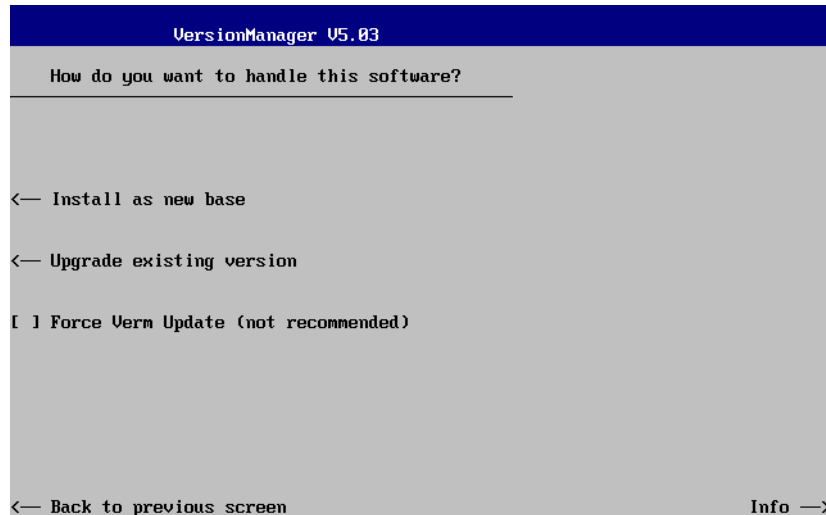

Note: *This dialog is skipped if the new base software version is not compatible with any of the existing configurations. An incompatible new base software must be installed as a new base software.*

Install as new base Create a new configuration based on the base software to be installed. The upgrade selection dialog described below is skipped. Network options can be assigned to this base software in a second stage of the installation.

Upgrade existing v. Select an existing configuration and replace the base software of this version. To this end, the upgrade selection dialog described below is opened.

Force Verm update If the option is checked the current *VersionManager* is overwritten every time that a new base system is installed, even if this means a downgrade of the *VersionManager* version. This feature is primarily for service purposes.

After selection of an upgrade software version compatible with one of the configurations stored on the hard disk, the upgrade selection dialog is called up:

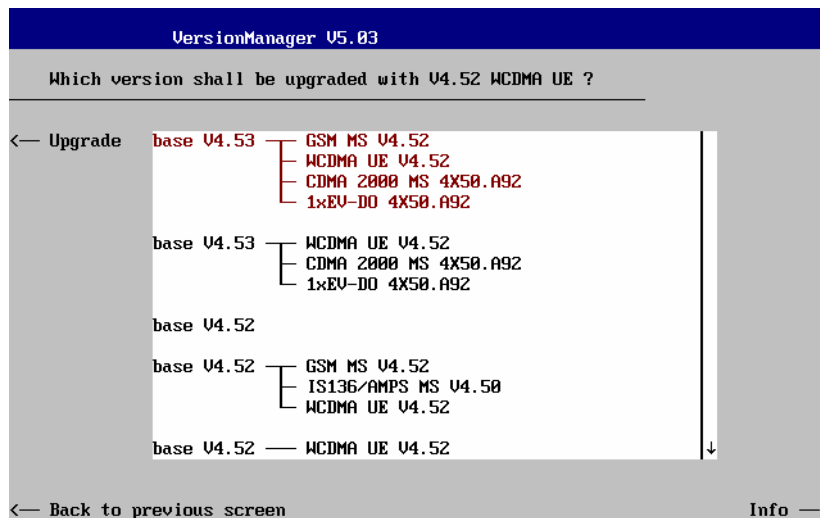

Upgrade Replace the base software version or network option selected in the *software version* selection dialog.

Alternatively, if none of the configurations stored on the hard disk is compatible with the software version selected, an error message is displayed. E.g., for an incompatible Bluetooth version:

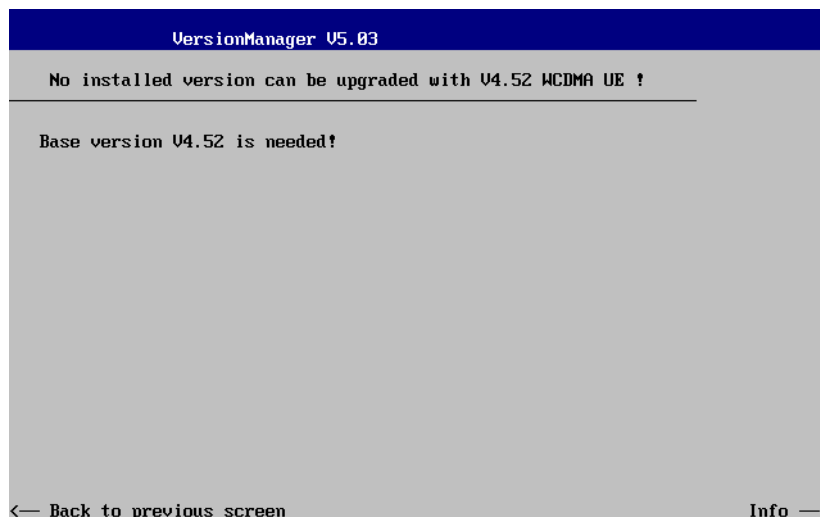

Back to... Close the current screen and go back to the *software version* selection dialog to select a compatible software version.

Terminating the software update: After successful installation of each software version the CMU displays the following screen:

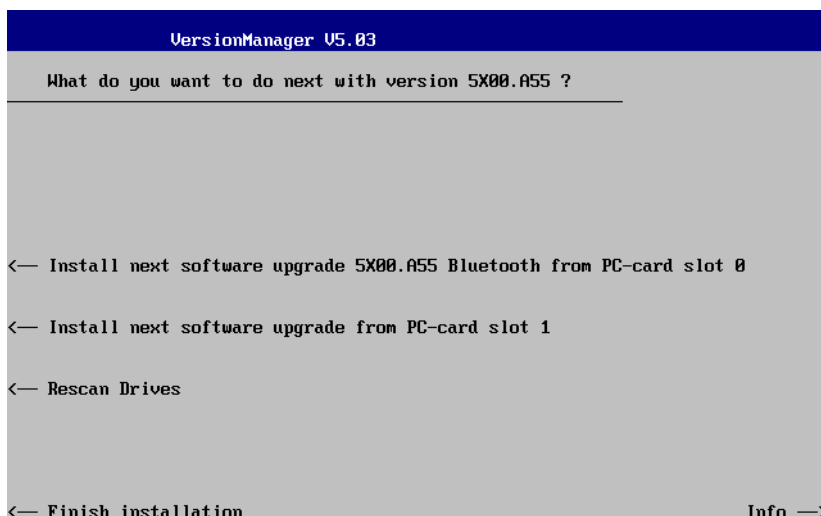

Install next software... Go back to the *software version* selection dialog to select additional software modules to be installed in the same *VersionManager* session. This function depends on the storage media and the number of software installation versions available; see [Table 1-3](#) on page [1.31](#).

Rescan Drives... Rescans the external and internal drives in order to detect new software installation versions and update the screen accordingly.

Finish installation Close the *VersionManager* and reboot the CMU (remove the external disk from the disk drive). The installed firmware configurations are then operational. The last configuration installed is taken as the active configuration in the subsequent measurement session.

Note: **Notice messages after firmware updates**

In most cases firmware updates do not affect the accuracy of the measurements. There are some exceptions where a correction procedure must be executed in the Maintenance menu after the firmware update. The R&S CMU displays a notice message whenever this happens. The box contains the name of the required correction procedure and appears during startup until the correction has been performed.

Lack of disk space: Before installing the next software version, the CMU checks whether there is enough disk space on the hard disk. If not, the following dialog is displayed:

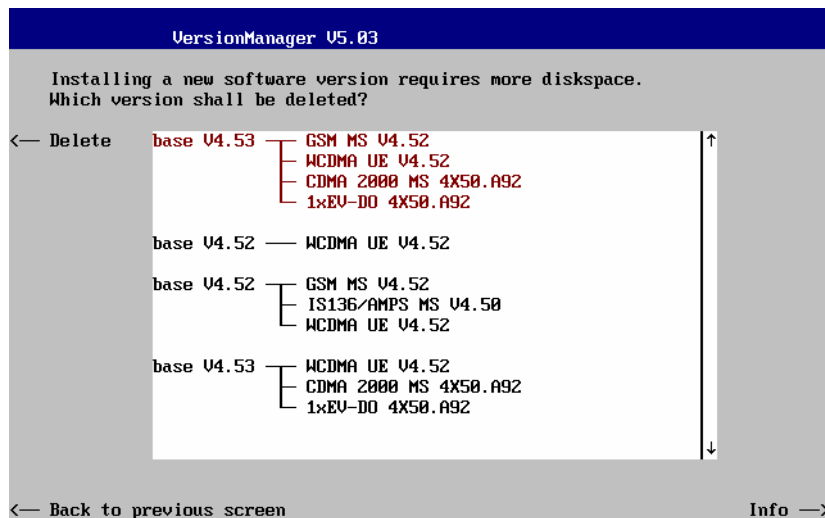

Delete Delete the current version and return back to the previous screen.

List software

List software opens a list of all available firmware configurations. It is possible to activate and delete configurations from the list; see description of *Activate software* and *Delete software* functions above.

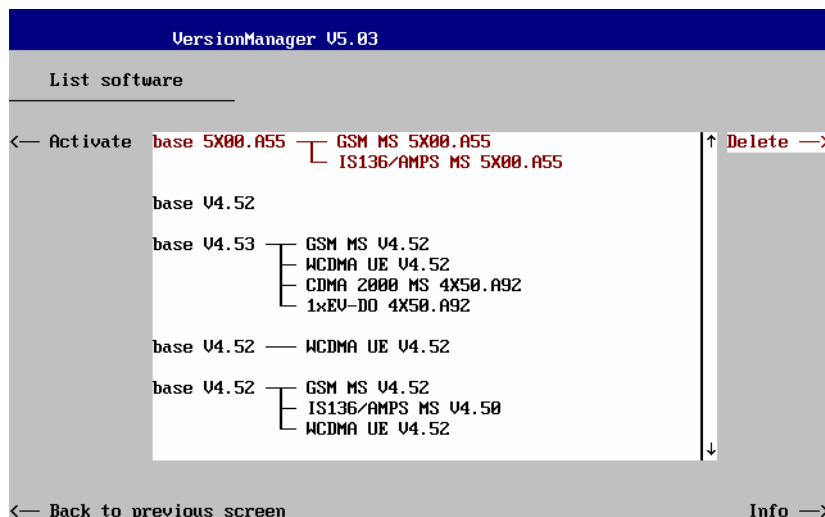

Firmware update after board change(...)

This function depends on whether a user correction file named *USERCOR1.DAT* is stored in the directory *INTERNAL\USERCOR* of the internal hard disk.

- If no user correction file is available, *Firmware update after board change* performs an update of the current firmware including a complete CMU hardware detection. No external installation disk is required. The update takes some time and should be attempted in case of problems or after a modification of the CMU hardware configuration only (also after a combined hardware/software exchange).
- If a user correction file is found, *Firmware update after board change...* opens a submenu to activate or deactivate the RF user correction; see section [Compiling and Loading User Correction Tables](#) on p. 1.40 ff.

Edit service tables

Edit service tables calls up the *Service Table Editor* menu showing all hardware modules that are possibly fitted in your instrument. For service

purposes, further information can be obtained by typing a particular board name and board index in the two lines below the table.

| | |
|--------------------------------------|---|
| Exit | <i>Exit</i> closes the <i>VersionManager</i> and resumes the CMU start-up procedure. |
| Write log files to disk | <i>Write log files to disk</i> copies all *.log files stored on the CMU hard disk to an external storage medium (floppy or CF / PCMCIA card). The *.log source files on the hard disk are not deleted. The <i>Write log files to disk</i> function opens a blue message box indicating the storage capacity of the external disk needed. The *.log files can be distributed over several disks. If no disk is available, the <i>VersionManager</i> displays a warning and does not start copying. |
| Delete non volatile ram | <i>Delete non volatile ram</i> deletes all entries stored in the non volatile ram of the CMU. This memory contains particular settings of the last CMU session that can be reused in the next session (e.g. the last active function group and measurement menu, special configuration etc.). Deleting the non volatile ram can be useful after an abnormal termination of a CMU measurement session. Note: <i>The settings stored in the non volatile ram can also be written to a configuration file and reused in later sessions; see Chapter 3, section Saving Configurations.</i> |
| Scan disk | <i>Scan disk</i> closes the <i>VersionManager</i> , executes the MS <i>Scan Disk</i> program and finally returns you to the <i>VersionManager</i> . Refer to your <i>Scan Disk</i> documentation for further information. Note: <i>This function is not available while a base software version <V3.00 is active.</i> |
| List all versions to disk | <i>List all versions to disk</i> writes the software configurations indicated via <i>List software</i> to an ASCII text file that is stored on the external disk. |
| Copy non volatile ram to disk | <i>Copy non volatile ram to disk</i> copies the contents of the non volatile ram to the external disk (floppy, CF / PCMCIA). In this way, the settings stored in the non volatile ram can be used on another CMU. |
| Defragment disk | <i>Defragment disk</i> closes the <i>VersionManager</i> , executes the MS <i>Defrag.exe</i> program and finally returns you to the <i>VersionManager</i> . Defragmenting the hard disk is suitable to improve performance after installing and deleting many different software versions. Refer to your <i>Defrag.exe</i> documentation for further information. Note: <i>This function is not available while a base software version <V3.00 is active.</i> |
| Info | <i>Info</i> opens an output window displaying information on the current screen. Separate <i>Info</i> windows are provided for the different <i>VersionManager</i> dialogs. |

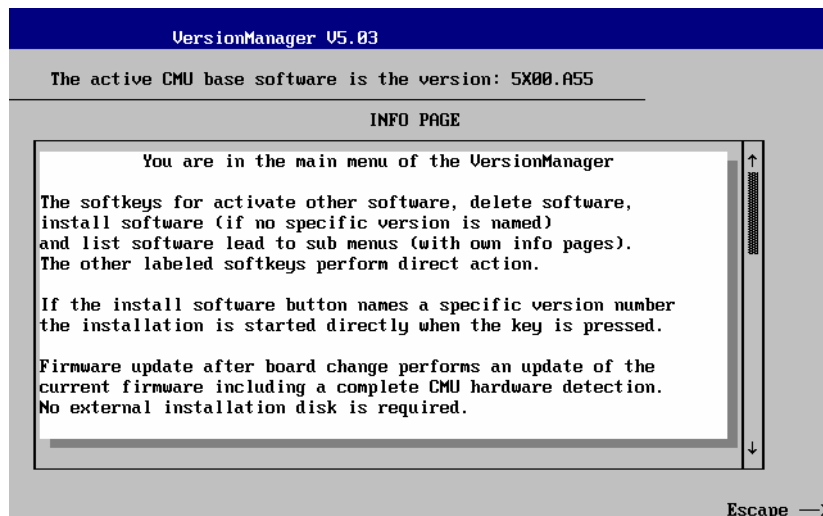

Escape Close the Info screen and return to the previous screen.

Error and notify message

During operation, the *VersionManager* can display two different types of messages:

- Error messages indicating that an action could not be successfully performed are displayed in yellow boxes. All error messages with possible reasons and remedial actions are explained in Chapter 9 of this manual.

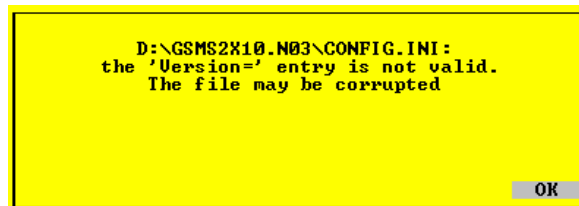

- Notify messages describing ongoing processes of the instrument are displayed in blue boxes. These messages are self-explanatory and do not require an action to be taken by the user.

RF User Correction

The purpose of the RF user correction is to compensate for an inevitable frequency and level-dependent attenuation in the test setup (frequency and level response correction). Level correction values are determined by means of a signal generator or power meter connected to the CMU's input and output ports and stored to a file, which is transferred to the CMU in order to modify its RF generator level and to correct its RF analyzer results.

The correction values must be acquired independently for the input and output connectors of the instrument.

Note: In addition to the RF user correction described here, the instrument provides a frequency-dependent input and output attenuation for each function group. The frequency-dependent attenuation is defined in the RF \odot tab of the Connection Control menu; refer to Chapter 4 in this manual or in the manuals for the relevant network options.

Output level correction

The correction values for output signals (connectors RF1, RF2 or RF3 OUT) modify the RF generator level so that the actual RF signal power at the input of the DUT is equal to the nominal RF generator level.

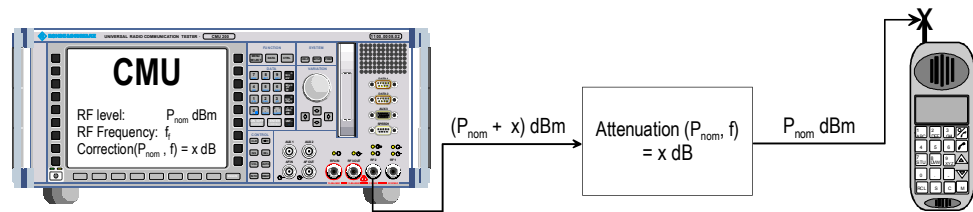

Input level correction

The correction values for input signals (connectors RF1, RF2 or RF4 IN) modify the measured analyzer level so that the result for the RF signal power is equal to the power transmitted by the DUT.

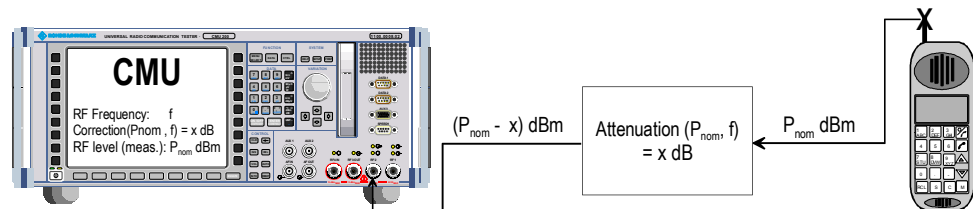

Once the correction tables have been transferred to the instrument, the RF user correction is an internal procedure. There are several advantages of using this internal correction method rather than post-processing the CMU results by means of an external measurement program:

- The input level correction affects all acquired RF power results³ including derived quantities (e.g. the results of the limit check) without slowing down the speed of the measurements. Evaluating derived quantities by means of an external program can be tedious. The RF user correction ensures that all results, including the derived ones, are consistent.
- The user correction is included in all results displayed in the measurement menus.
- Correction data can be acquired individually for each instrument and stored to its internal hard disk. If several testers are used in a production measurement system, the individual units are independent from each other and interchangeable.

³ Exception: The wideband power, which is provided in the *Analyzer/Generator* menu of the *RF* function group and in many network test applications, is always uncorrected.

Compiling and Loading User Correction Tables

To generate user correction tables and activate the user correction proceed as follows:

To deactivate old user correction (if available)...

1. Start the CMU and press the *Menu Select* key after the boot-up sequence is terminated (from the moment when the CMU display turns black until the end of the 3-beep acoustic signal) to activate the *VersionManager*.
2. Select *Firmware update after board change...*
3. In the submenu opened, select *Firmware update after board change without user correction* and *Back to previous screen*.

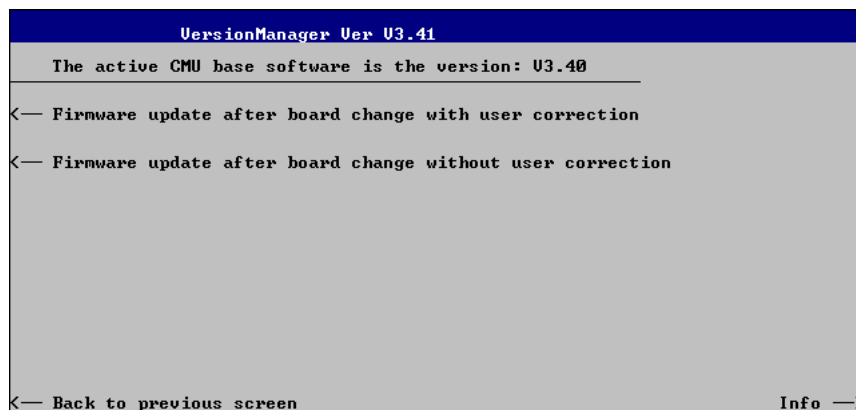

The CMU closes the *VersionManager* and resumes the start-up procedure.

4. Open the *Data* menu and access the *Arrange* tab. Delete or rename the old user correction file stored in the directory *INTERNAL\USERCOR\USERCOR1.DAT*.
5. Press *Menu Select* to close the *Data* menu and access the *Menu Select* menu.

Settings for acquiring correction values

The following settings and precautions will ensure maximum accuracy of the user correction:

6. From the *Menu Select* menu, access the *RF* function group or one of the network test options that will be used for the corrected measurements.
7. In the *RF* \oplus tab of the *Connection Control* menu, select the external input and output attenuation factors (*Ext. Att. Input*, *Ext. Att. Output*) that will be used for the corrected measurements.
8. In the *Analyzer* tab of the *Connection Control* menu, select the RF input path attenuation (*Analyzer Level – RF Attenuation: Normal, Low Noise or Low distortion*) that will be used for the corrected measurements and set the *RF Mode* to *Manual*.

Note: The CMU provides a various mechanisms for automatic input level control, e.g. the *Analyzer Level – RF Modes Auto (autoranging)* and *PCL (in GSM-MS networks)*. To avoid unexpected effects, it is recommended to deactivate these control mechanisms and always measure the correction values at constant (Manual) maximum input level.

To acquire the input correction values...

9. Apply the RF output signal of an external signal generator to one of the RF input connectors RF1, RF2, or RF4 IN of the CMU using the test setup (cables, power splitters, antenna coupler...) that will be used for the corrected measurements.
10. Vary the level and frequency of the signal generator and calculate the correction values as the difference between the external generator level and the measurement result at the CMU. If necessary, adapt the external input attenuation (see step 7) to force the correction values into the allowed range of [-1.2 dB, +1.2 dB].

To acquire the output correction values...

11. Apply the RF generator signal of the CMU to one of the RF output connectors RF1, RF2, or RF3 OUT of the CMU and feed it to a power meter, using the test setup (cables, power splitters, antenna coupler...) that will be used for the corrected measurements.
12. Vary the level and frequency of the CMU generator signal and calculate the correction values as the difference between the generator level and the measurement result at the external power meter. If necessary, adapt the external output attenuation (see step 7) to force the correction values into the allowed range of [-1.2 dB, +1.2 dB].

To activate the user correction...

13. Repeat the steps no. 9 and 11 for all input and output connectors needed and write the acquired correction values into a common file named *USERCOR1.DAT* with the format specified in section [File Format for User Correction Tables](#) on p. 1.42 ff.
14. Transfer the file to the CMU using the IEEE bus, the serial interface or the CF / PCMCIA slot and copy it to the directory *INTERNAL\USERCOR*.
15. Shutdown and re-start the CMU and press the *Menu Select* key after the boot-up sequence is terminated (from the moment when the CMU display turns black until the end of the 3-beep acoustic signal) to activate the *VersionManager* again.
16. Select *Firmware update after board change...*
17. In the submenu opened (see step no. 3), select *Firmware update after board change with user correction*.

The CMU checks the file *USERCOR1.DAT* for compatibility with the file format specification and generates a message, should an error be detected. Afterwards, the CMU closes the *VersionManager* and resumes the start-up procedure. A message indicates that the user correction is active.

Final test

18. Repeat the steps no. 9 and 11 with active user correction to make sure that the entire procedure was performed without errors.

File Format for User Correction Tables

The user correction file is an ASCII file named *USERCOR1.DAT* that is stored in the directory C:\INTERNALUSERCOR\ on the internal hard disk of the CMU. The file contains up to 6 independent tables to store the correction values for the 3 RF output connectors and the 3 RF input connectors of the instrument. Each table has the following structure:

```
[PortID]:          [Freq1]           [Freq2]           ...           [Freqn]
[Level1]:          [Dev11]           [Dev12]           ...           [Dev1n]
[Level2]:          [Dev21]           [Dev22]           ...           [Dev2n]
...
[Levelm]:          [Devm1]           [Devm2]           ...           [Devmn]
```

Comments in the file must be introduced by a double dagger #. Spaces and indentations are allowed for easier readability of the file. The first character in a line can be a minus sign but must not be a plus sign. The following example shows a valid user correction file:

```
# This is a comment
# (any number of spaces is allowed)
#   indentations are allowed,
# spaces and TAB are used for separation
RF2in:  500   1000   1500   2000
10:     1.20  -1.2   -0.23  -0.5   # comments are allowed at the end of a line
0:      0.34   1.14   1.20   -1.2
-10:    1.19  -1.19  -1.12   1.00
-14:   -0.32  +1.11  -0.50   1.10

RF1in:   200     800     1500
10:     +1.20   -.91     .5
0:      -0.12  +1.11   -0.50

RF3OUT:  400   1000   1555   2500
10:     1.20  -1.20  -0.23  -0.5
0:      0.34   1.14   1.20  -1.2
-10:    1.19  -1.19  -1.12   1.00
-14:   -0.12  +1.11  -0.50   1.10
```

Note: *In general RF user correction tables are no longer valid after an update of the path correction data, e.g. by means of the automatic calibration system R&S ACS. To ensure that outdated user correction data are not used inadvertently, the ACS renames all files c:\internal\usercor*.dat ➔ c:\internal\usercor*.bak after a change of the path correction data. Existing *.bak files are overwritten.*

Ranges of Values and Limitations

The table contains the following elements:

- PortID** Identifier for the RF connector, written in upper or lower case letters and followed by a colon. The following port IDs are valid:
RF1IN, RF2IN, RF4IN for the 3 RF input connectors (input level correction)
RF1OUT, RF2OUT, RF3OUT for the 3 RF output connectors (output level correction)
- Frequency points** Frequency of the measured or generated signal in MHz, to be arranged in ascending order, starting in column 2 (lowest frequency). The frequency points must be integer numbers (i.e. integer multiples of 1 MHz) and can be distributed across the entire RF input and output frequency range of the instrument (see data sheet).

| | |
|--------------------------|--|
| Level points | Level of the measured or generated signal in dBm, to be arranged in descending order, starting in row 2 (highest level). The level points must be positive or negative integer numbers, followed by a colon, and can be distributed across the entire RF input and output power range of the connectors (see data sheet). Negative levels must be preceded by a minus sign “-”; using a plus sign “+” for positive numbers is not allowed. |
| Correction values | <p>n times m level correction values for the measured or generated signal in dB (if n is the number of frequency points, which is equal to the number of correction values per table row, and m is the number of level points). The total number of correction values n times m must not exceed 120 (it is possible though to choose m=120 and n=1 and vice versa).</p> <p>The level correction values must be in the range between -1.20 dB and +1.20 dB. This is sufficient to compensate for a frequency response or level response caused by the test setup. Larger, correction factors can be defined by combining the user correction with a constant external input or output attenuation (see section <i>RF Connectors</i> in Chapter 4). Two consecutive correction values may be separated by any number of spaces or tabs.</p> <p>Positive (negative) correction values for an output signal compensate for an external attenuation (gain) and increase (decrease) the generator level. Positive (negative) correction values for an input signal are added to (subtracted from) the measured RF signal levels.</p> |

Interpolation Rules

The CMU uses the values in the correction tables to interpolate correction factors at arbitrary frequency and level values. The following rules apply:

- At constant frequency, the correction value associated with the level point P_m is valid in the level range between $(P_{m+1} + P_m)/2$ and $(P_{m-1} + P_m)/2$: The ranges with constant value adjoin each other in the middle between two consecutive level points.
- At constant level, the correction factors are linearly interpolated between consecutive frequency points.

Contents

- 2 Getting Started 2.1**
 - A Short Tutorial on CMU Operation.....2.1**
 - Condensed Operating Instructions.....2.1
 - How to access and close menus.....2.2
 - How to use dialog elements in the menus2.3
 - Startup of the CMU2.4**
 - RF Measurements.....2.8**

2 Getting Started

The following chapter presents a sample session with the universal radio communication tester CMU. It is intended to provide a quick overview of the settings provided in the base system and the *RF* function group. No specific device under test is required. For an introduction to mobile network tests (e.g. tests of GSM900/1800/1900 mobile phones) please refer to the relevant operating manuals.

Before starting any measurement with the CMU, please note the instructions given in Chapter 1 for putting the instrument into operation. In this chapter and in Chapters 3 to 4 of the complete operating manual you will find detailed information on customizing the instrument and the display according to your personal preferences.

The steps to perform are explained on the left side of each double-page together with the results obtained on the CMU screen. On the right side, additional information is given. We also point out alternative settings and related measurements which could not be reported in detail.

For a systematic explanation of all menus, functions and parameters and background information refer to the reference part in Chapter 4 of the operating manual.

A Short Tutorial on CMU Operation

The principles of manual operation – controls, operating menus, dialog elements and measurement control – are discussed in Chapter 3 of the operating manual. Below we list some essentials for first users:

Condensed Operating Instructions

1. Press the *RESET* key on the front panel to set the instrument to the default state before you configure a new measurement.
2. Press *ENTER* to confirm selections, even if *No* or *Yes* is displayed.
3. The *MENU SELECT* front panel key can be pressed in any state of the unit. A large popup menu is then displayed in which the function group (network etc.), signalling mode, and measurement menus can be selected. Activate by pressing *ENTER*.
4. A front-panel LED indicates which of the RF connectors is configured as output. In the menu, the RF generator can be activated or deactivated with *ON/OFF* (green/red). The front-panel LED goes out if the generator is in the *OFF* position.
5. A front-panel LED indicates which of the RF connectors is configured as input. In the menu, the measurement can be controlled via the *ON/OFF* and *CONT/HALT* keys (*ON* (green), *OFF* (red) and *HLT* (yellow) states). In the *OFF* state, the LED goes out.
6. The *SETUP* hardkey allows to make static, measurement-independent default settings such as *Remote* or *Time*, to check which options are installed and to activate new software options.
7. The softkeys to the right of the menus are used to change the hotkeys across the bottom and their functions. Pressing the *Menus* softkey (bottom right) allows a fast switchover between related menus using the hotkeys.

How to access and close menus

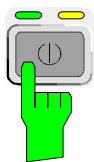

A startup menu is displayed automatically when the CMU is switched on.



Some general configuration and selection menus can be opened via the *MENU SELECT*, *RESET*, *INFO*, *PRINT*, *HELP* or *SETUP* keys on the front panel.

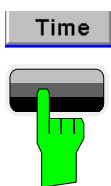

The hotkeys displayed across the bottom of a main menu or graphical measurement menu are used to switch over between different main menus or graphical measurement menus. Tabs in popup menus are also accessible via hotkeys.

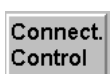

The *Connect. Control* softkey (always at the top right) is available in all measurement menus. This softkey opens a popup menu defining the input and output connectors, the external attenuation, the reference frequency as well as many network-specific settings.

In the *Signalling* test modes of many network options, the *Connection Control* menu is also used to set up and terminate a connection between the CMU and the DUT.

The *Connection Control* menu also contains the input path and the trigger settings for the current function group and signalling state.



If a special configuration menu exists for a measurement or for a generator the corresponding softkey is marked with a yellow arrow. The configuration menu is opened by pressing the softkey twice.



All CMU popup menus can be closed with the *ESCAPE* key.

Main menus and graphical measurement menus are closed on switching to another main or graphical measurement menu.

How to use dialog elements in the menus



The dialog elements assigned to a softkey are selected by pressing the softkey.



Different input fields can be selected by means of the 4 cursor keys (blue frame shows active input field).



One of several elements in a list or toggle switch can be selected with the rotary knob.



Numeric values can be either incremented/decremented using the rotary knob or entered via the numeric keypad or an external keyboard.

For a comprehensive introduction to manual operation of the CMU refer to Chapter 3 of the operating manual.

Startup of the CMU

This section describes how to customize the CMU and perform simple RF measurements. As a prerequisite for starting the session, the instrument must be correctly set up and connected to the AC power supply as described in Chapter 1.

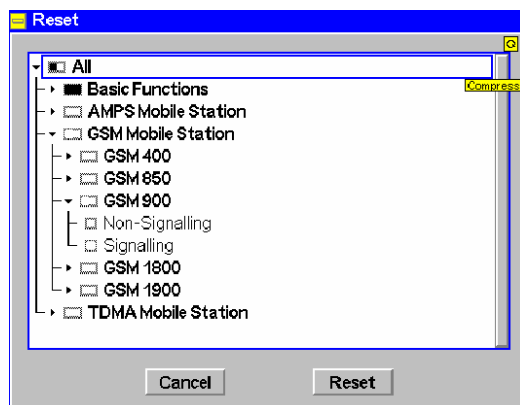
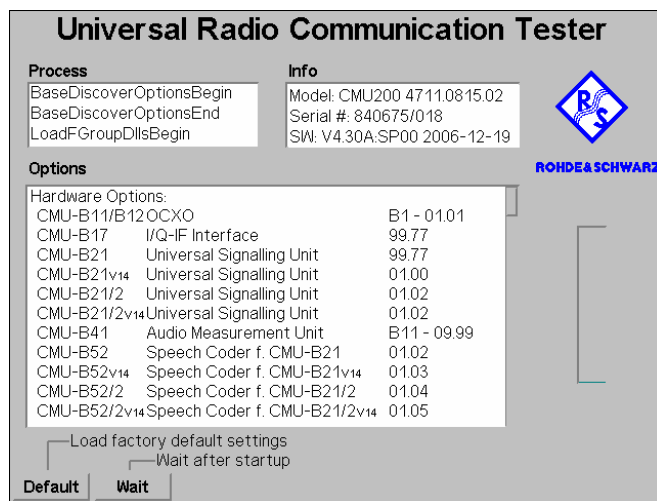
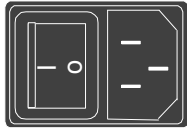

Step 1

- Switch on the CMU using the mains switch at the rear. ①
- Check the operating mode of the instrument at the *ON/STANDBY* key on the front panel. If the CMU is in standby mode, press the *ON/STANDBY* key. ②

Step 2

The CMU is booted and after a short while displays the startup menu. This menu is usually closed as soon as the instrument software is loaded and the startup test is finished. ③

- Press the *Wait* hotkey to prevent the instrument from switching to another menu. ④

The *Wait* hotkey changes to *Cont.* with the additional message *Change to last menu* displayed on top.

- Press the *Cont.* hotkey to resume the startup process.

Step 3

- Press the *RESET* key to open the *Reset* popup menu.
- Proceed as described in Chapter 4 of the operating manual, section *Reset of Instrument Settings*, to expand the tree of function groups.
- Select the function groups *Base* and *RF* to be reset (the corresponding nodes must be black).
- Use the cursor keys to activate the *Reset* button and press *ENTER*.
- In the popup window opened (*Are you sure?*), select *Yes* to confirm the instrument reset.

The CMU indicates that it performs a partial reset of the two selected function groups and is then ready to carry out the following steps. The *Reset* popup menu is closed automatically.

Additional Information...

... on Step 1

① Mains switch on the rear panel

When the mains switch at the rear is set to the *O* position, the complete instrument is disconnected from the power supply. When the mains power switch is set to the *I* position, the instrument is in standby mode or in operation, depending on the position of the *ON/STANDBY* key on the front panel.

② ON/STANDBY key on the front panel

The *ON/STANDBY* key at the front of the instrument determines whether the instrument is in standby mode or in operation.

Standby mode:

Only the OCXO reference frequency oscillator (option CMU-B11/B12), if installed, is supplied with operating voltage. The orange LED (*STANDBY*) is illuminated.

Operation:

The green LED (*ON*) is illuminated and all modules of the instrument are supplied with operating voltage.

... on Step 2

③ Startup menu

The startup menu displays the following information:

- The startup procedure (*Process*)
- Instrument model, serial number and version of the CMU base software (*Info*).
- Installed hardware and software options and equipment (*Options*). Available software options are listed with their version numbers.
- Progress of the startup procedure (*Startup bar graph*).

④ Wait hotkey

By default the CMU switches to the last main menu of the previous session after terminating the startup process. This is convenient if an interrupted session is to be resumed or if the instrument is generally used in a definite operating mode.

On the other hand, the *Wait* function can be used to access the configuration menus which can be opened by means of the front panel keys before the actual measurement is started.

While the *Wait* hotkey is active, a reset of the instrument is not possible.

Alternative Settings and Measurements

☞ Chapter 1

The CMU is automatically set to the AC supply voltage and frequency applied. Note the permissible ranges of AC voltages and frequencies indicated at the rear of the instrument and in the data sheet.

☞ Chapter 1

The behavior of the CMU when it is switched off depends on the Front Module controller type installed.

☞ Chapter 4 of the operating manual

The *Default* hotkey can be used to load the factory default settings for all function groups. Settings made and stored in the previous session are overwritten.

The CMU's user interface has been optimized with the aim of facilitating fast and easy switch-over between the menus and measurement modes. This includes the general configurations which can be accessed from any measurement menu.

The most important selection and configuration menus such as *Reset*, *Setup*, *Menu Select* etc. are directly accessible via front panel keys.

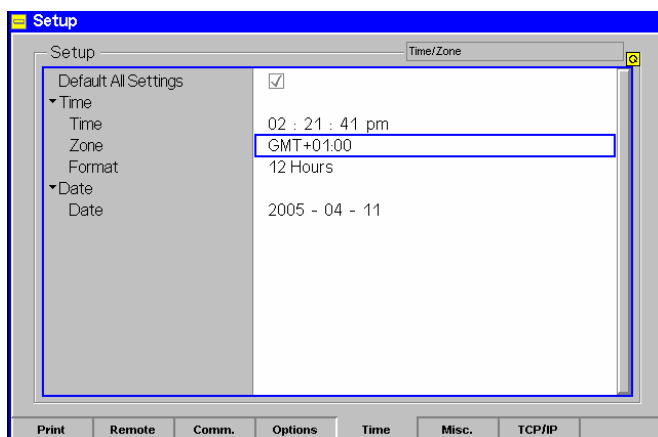

Step 4

- Press the *SETUP* key to access general device settings.

- Press the *Time* hotkey to switch over to the *Time* tab of the *Setup* menu. ①

Step 5

The *Time* tab of the *Setup* menu displays the current time zone, time and date. ②

- Use the rotary knob to move the focus onto the *Time* section of the *Setup* table. If necessary, press the rotary knob or the *ON/OFF* key to expand the parameters in the table (see Chapter 3 of the operating manual).
- Move to one of the input fields associated to the *Time* parameter, select with *ENTER* and use the rotary knob or the numeric keypad to correct the settings for the current time. Hours, minutes and seconds can be edited separately.
- Press *ENTER* to confirm the entries and quit the input fields.
- Move to *Zone* select field, activate with *ENTER*, and use the rotary knob to choose your own time zone.
- In the same way, activate the *Format* select field and use the rotary knob to switch over between European and North American time conventions.

Additional Information...**... on Step 4****① Softkeys and hotkeys**

Softkeys and hotkeys are activated by pressing the associated keys on both sides and across the bottom of the display. The general purpose of softkeys is to provide settings, control the generator and the measurements. Hotkeys are used to switch over between different menus and different tabs belonging to a popup menu.

... on Step 5**② Setup menu**

The *Setup* menu comprises several tabs providing general instrument settings. It is advisable to check and adjust the factory settings when you operate the CMU for the first time.

To switch over between the tabs of the setup menu use the hotkeys displayed at the bottom of the display.

Alternative Settings and Measurements

Chapter 3 of the operating manual



Chapter 4 of the operating manual

The different types of menus and control elements of the graphical user interface is explained in Chapter 3 of the operating manual. In the same chapter you can find a short tutorial on the entry of numbers and characters.

RF Measurements

In the *RF* function group, a continuous or pulsed RF signal can be generated and a RF signal with definite frequency characteristics can be analyzed. The signal level can be plotted in oscillographical (*Power*) or spectral (*Spectrum*) representation.

MENU
SELECT

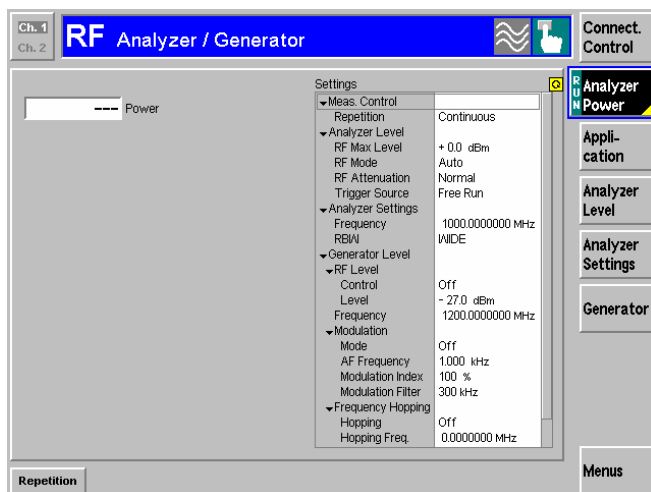
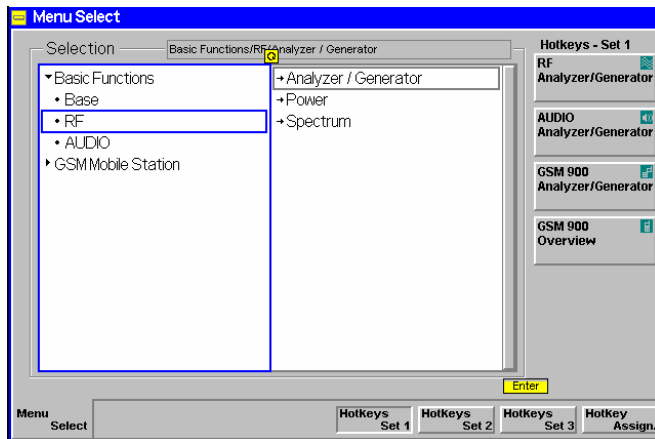

Step 1

- Press the *Menu Select* key to open the *Menu Select* menu. ①
- Use the cursor keys and the rotary knob to select the *RF* function group in the left half of the *Selection* table.
- In the right half of the table, select the *Analyzer/Generator* menu.
- Press the *Enter* key to activate the measurement selected and open the *RF Analyzer/Generator* menu.

Step 2

In the *Settings* table the *Analyzer/Generator* menu indicates the parameters of the signal generated and those of the signal received and analyzed. ②

At present, all parameters have been reset to factory default values. Different soft-key/hotkey combinations and popup menus are provided to change the settings. User-defined parameters will be saved for later sessions when the CMU is switched off.

The *Power* output field in the *Analyzer/Generator* menu shows an invalid result ("----") because at present no RF input signal is applied to the CMU.

Additional Information...

... on Step 1

① Menu Select menu

The *Menu Select* menu shows all function groups installed on your CMU. If a function group is selected the available test modes and measurement menus are indicated. Function groups representing digital network tests (such as *GSM400/850/900/1800/1900-MS*) are generally subdivided in the two test modes *Non Signalling* and *Signalling*, each containing a number of measurement menus.

The *RF* function group is available on any CMU regardless of the software options purchased. It comprises the three measurement menus *Analyzer/Generator*, *Power* and *Spectrum*. All three measurement menus are directly accessible from the *Menu Select* menu.

... on Step 2

② Analyzer/Generator menu

The *Analyzer/Generator* menu contains several softkeys to

- Control the RF signals received and analyzed (*Analyzer Level*, *Analyzer Settings*)
- Control the RF signals generated (*Generator*)

Defining a level and frequency via the *Generator* softkey and the associated hotkeys implies that a continuous signal (CW) with this level and frequency is generated.

The *RF Max. Level* defined via *Analyzer Level*, however, denotes the maximum input power which can be measured. This is identical with the upper edge of the *Power* diagram (see below). The permissible range of *Max. Level* depends on the input connector and external attenuation used (see section *Analyzer Settings* in Chapter 4).

Defining a (center) *Analyzer Settings – Frequency* implies that only signals around this frequency are analyzed.

The *Analyzer Settings – RBW* hotkey defines the resolution bandwidth of the analyzer.

③ The status of the *Analyzer Power* measurement is shown in the corresponding softkey. For ongoing measurements, the result in the *Power* output field is constantly updated.

At present no input signal is available so that the *Power* output field shows an invalid result “--”

Once the softkey is selected, the *Analyzer Power* measurement can be switched off and on by means of the *ON/OFF* key. In contrast, the *CONT/HALT* toggle key halts the measurement after the next valid result has been obtained.

Alternative Settings and Measurements



Chapter 4 of the operating manual

For digital network tests refer to the relevant operating manuals. e.g. *GSM400/850/900/1800/1900-MS*.



Chapter 4 of the operating manual

The *Generator* softkey provides the most important settings of the *Generator* tab of the *Connection Control* menu.

The *Analyzer Level* and *Analyzer Settings* softkeys correspond to the *Analyzer* tab of the *Connection Control* menu.



Ch. 4 and Ch. 5

The options for the measurement status are *ON*, *OFF*, or *HLT*. The *HLT* state is reached after the end of a single shot measurement (see the section about measurement control in Chapter 5 of the operating manual).

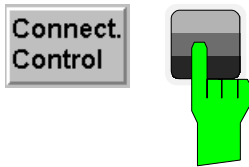

Step 3

- Press the *Connect. Control* softkey and use the *Generator* hotkey to open the *Generator* tab. ①

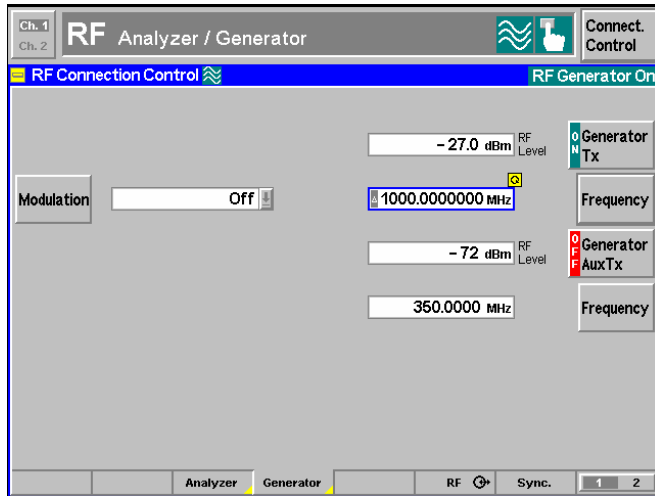

The *Generator* tab controls the RF generator and defines the *Frequency* and *Modulation* of the generated RF signal.

- Select the *Generator* softkey by pressing once.
- Press the *ON/OFF* key to switch the RF generator on. ③
- Set the generator frequency equal to the default frequency of the RF analyzer frequency as shown in the figure.
- Press the *RF* hotkey to open the tab defining the signal connectors and external attenuation.

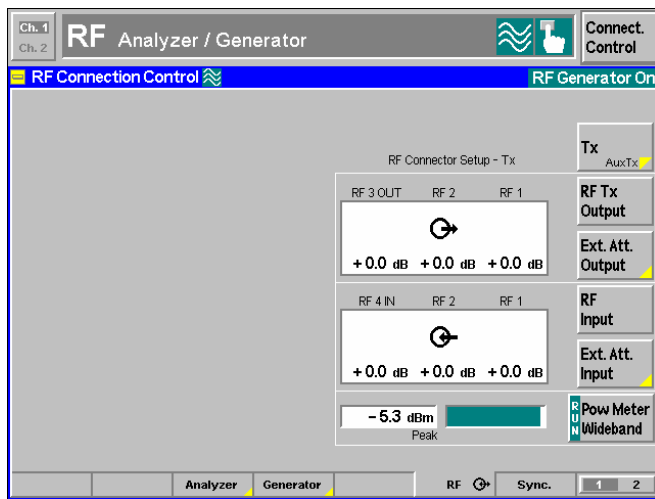

- Select RF 2 as output connector, RF 4 IN as input connector. Do not define any external attenuation (all values equal to 0.0 dB).

Two yellow LEDs on the front panel indicate the input and output connectors selected.

- Use a coax cable to connect RF 2 to RF 4 IN.
- Press the *ESCAPE* key to close the popup menu and return to the *RF Analyzer/Generator* main menu.

The RF level measured is now indicated next to the *Analyzer Power* softkey. Due to the loss in the signal path it should be slightly below the generator power selected. ②

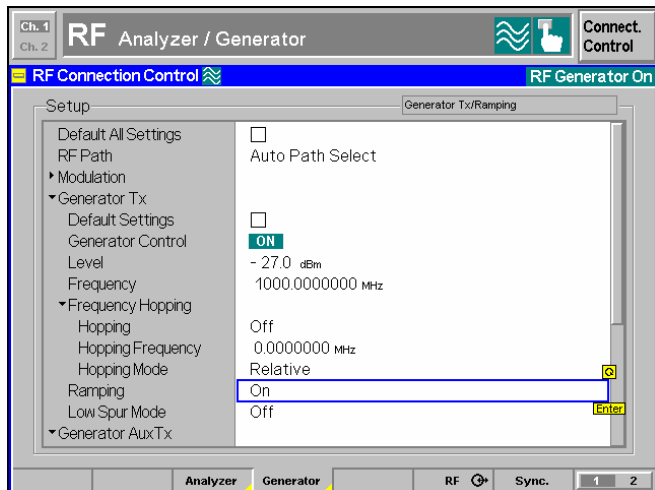

- Reopen the *Connection Control* menu and press the *Generator* softkey twice.

The table-oriented version of the *Generator* tab is opened.

- Press *ON/OFF* to expand the parameter tree, use the rotary knob to select the *Ramping* parameter, press *Enter* and use the rotary knob again to switch the power ramping *ON*.

Now the generator transmits a pulsed (instead of a continuous) signal.

Press the *Connect. Control* softkey again or the *ESCAPE* key to close the popup menu.

Additional Information...

... on Step 3

① RF connectors

The *RF Connection Control* menu configures the input and output connectors in the *RF* function group. The four connectors on the front panel differ by their permissible range of input and output powers (see Chapter 4 of the operating manual and data sheet). The values quoted on the left side are compatible with the rated specifications.

② External attenuation

An external attenuation can be reported to the CMU in order to compensate for known losses between the signal source and the device under test or the analyzer.

In our example, the (positive) difference between the analyzer power measured and the generator power can be reported as an external output attenuation at RF 2. The RF generator increases its level to maintain the commanded power of -27 dBm at the analyzer. The nominal generator power set in the RF level field is thus measured and indicated next to the *Analyzer Power* softkey.

Note: RF User Correction

In addition to the static external attenuation settings, the CMU provides systematic, frequency and level-dependent correction mechanisms of the generated and measured RF power:

- *In many function groups (e.g. the present RF group) a frequency-dependent attenuation can be defined after pressing Ext. Att. Output or Ext. Att. Input twice.*
- *Global, frequency and level-dependent correction tables can be loaded using the VersionManager; see section RF User Correction in Chapter 1 of the complete R&S CMU operating manual.*

Alternative Settings and Measurements

☞ Chapter 4 of the operating manual

Settings made in the *Connect. Control* menus apply to the entire function group *RF Non Signalling*.

☞ Chapter 4 of the operating manual

Note that an external attenuation reported to the CMU shifts the nominal permissible ranges of input and output levels.

Power

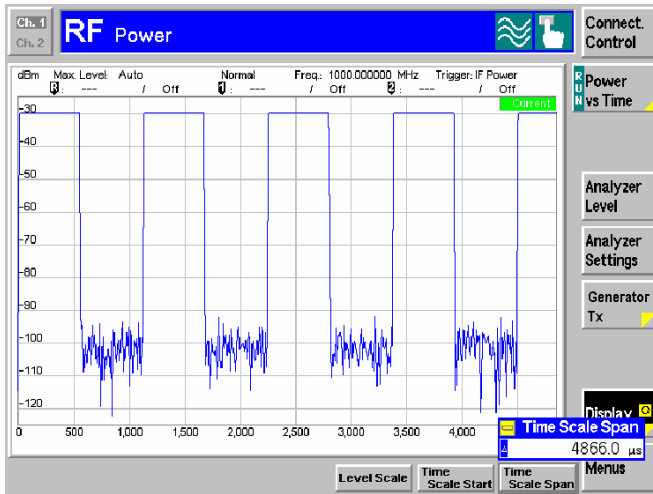

Spectrum

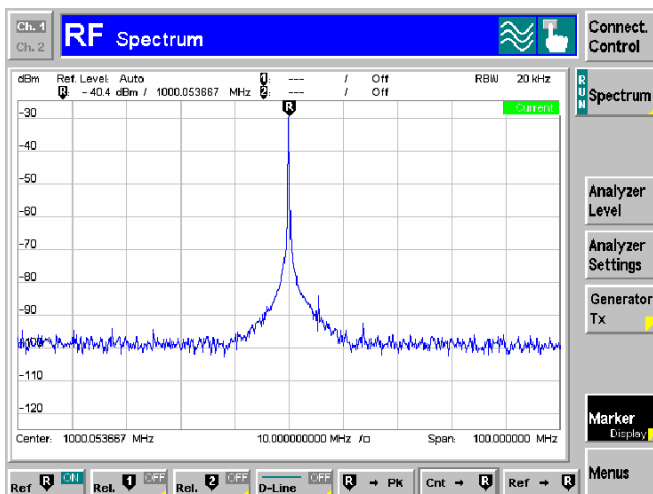

Step 4

- Press the *Power* hotkey to switch over to the graphical menu *Power*.

The *Power* menu shows the RF signal power measured as a function of time at a particular frequency and resolution bandwidth. An appropriate trigger condition must be selected to obtain a stable display. ①

Settings (default settings or the ones made in the *Analyzer/Generator* menu) and scalar results are displayed in two parameter lines above the diagram.

Various tools allowing to take a closer look at the measurement results are provided in the graphical measurement menu. ②

- Press the *Marker/Display* softkey twice and vary the *Time Scale* to display several pulses in the diagram.
- Press the *Analyzer Settings* softkey and vary the resolution bandwidth (hotkey *RBW*). ③
- Press the *Menu* softkey to display the hotkeys used to change over to the other measurement menus.
- Press the *Spectrum* hotkey to switch over to the graphical menu *Spectrum*.

Step 5

The *Spectrum* menu shows the signal power in spectral representation, i.e. as a function of the frequency.

The settings and results displayed in the two parameter lines above the diagram are analogous to the ones shown in the *Power* menu.

- Press the *Marker* softkey and use the *R to Pk* and the *Cnt to R* hotkeys to center the diagram. ④
- Press the *Analyzer Settings* softkey to scale the diagram and adjust the resolution bandwidth.
- To close your session set the CMU to standby mode using the power switch on the front panel or use the mains switch at the rear.

Additional Information...

... on Step 4



① Trigger mode

The trigger mode is set in the *Analyzer* tab of the *Connection Control* menu or via the *Trigger* softkey in the graphical measurement menus. With the default setting *Free Run* the measurement is not synchronized to the frequency of the incoming pulses: The trace is permanently shifted in horizontal direction.

To show a signal consisting of rectangular pulses (bursts) it is recommended to trigger by either the rising or falling edge of the IF power.

② Markers

Markers are a graphical tool used to locate points on a trace and read out their coordinates. A reference marker and two delta markers may be defined in the *Power* menu.

The reference marker  measures the absolute level of the trace, the delta markers  and  measure the distance between their position and the reference marker. All marker coordinates are shown in the two parameter lines above the diagram.

③ Resolution bandwidth

A spectrum analyzer can differentiate two spectral lines separated by a minimum distance corresponding to the bandwidth of the resolution filter.

The smaller the bandwidth the better the resolution and the larger the signal-to-noise ratio. If the resolution bandwidth is too large only the envelope of the spectrum can be measured.

In the *Power* measurement, the signal-to-noise ratio improves but the time resolution **deteriorates** when the resolution bandwidth is reduced.

... on Step 5

④ Scaling of the spectral diagram

The tools provided in the *Spectrum* menu are particularly suitable for scaling a spectral diagram with a sharp main lobe and symmetric, lower side lobes:

- The *R to Pk* hotkey (*Marker* softkey) places the reference marker to the maximum (i.e. the main lobe) of the diagram.
- The *Cnt to R* hotkey (*Marker* softkey) centers the diagram to the frequency of the main marker.
- Equivalently, the *Center* hotkey (*Frequency/RBW* softkey) can be used to center the diagram.

Alternative Settings and Measurements

 Chapter 4 of the operating manual

The *Frequency* softkey defines the frequency of the measured signal and the resolution bandwidth. The *Input Level* softkey configures the input level, the power range and an attenuation factor. The *Time* softkey configures the time axis.

 Chapter 4 of the operating manual

In addition to markers, a D-line can be used to measure a particular level in the diagram.

 Chapter 4 of the operating manual

 Chapter 4 of the operating manual

Contents

| | |
|--|-------------|
| 3 Manual Operation | 3.1 |
| Controls | 3.1 |
| Rotary Knob..... | 3.2 |
| Front Panel Keys | 3.2 |
| Softkeys..... | 3.2 |
| Hotkeys | 3.3 |
| Operating Menus | 3.4 |
| Measurement Menu | 3.4 |
| Graphical Measurement Menus | 3.6 |
| Popup Menu | 3.7 |
| Operation of Popup Menu | 3.8 |
| Dialog Elements in the Menu | 3.9 |
| Input Fields | 3.9 |
| Input of Numbers | 3.9 |
| Input of alphanumerical characters | 3.11 |
| Select Fields in Popup Menu | 3.13 |
| Measurement Control | 3.15 |
| Configurations | 3.15 |
| Measurement Groups | 3.16 |
| General Settings..... | 3.17 |

3 Manual Operation

This chapter provides a survey of the R&S® CMU's operating concept. It includes a description of the basic menu types, the selection and setting of parameters, and a general discussion of measurement control. The operating menus in the R&S® CMU basic system, the RF function group, and optional extensions are described in greater detail in Chapter 4.

Operating concept The R&S® CMU was designed for easy, intuitive operation. All menus rely upon a limited number of controls with analogous or identical function. Basic settings are discussed in section *Measurement Control* on page 3.15 and in Chapter 5.

Basic elements The R&S® CMU is operated via softkeys and tables. Softkeys provide fast access to the instrument functions. Tables facilitate the management of larger amounts of data.

Flexibility and uniformity The R&S® CMU can switch between various operating modes (multi-mode operation). For this purpose, it is possible to navigate between menus in almost any instrument state. The different function groups (*RF, Base, GSMxxx-MS* etc.; see also separate manuals for network test applications) operate in the same way; with measurements of the same type belonging to different applications being standardized.

Controls

The R&S® CMU is operated under menu control via keys, softkeys and hotkeys:

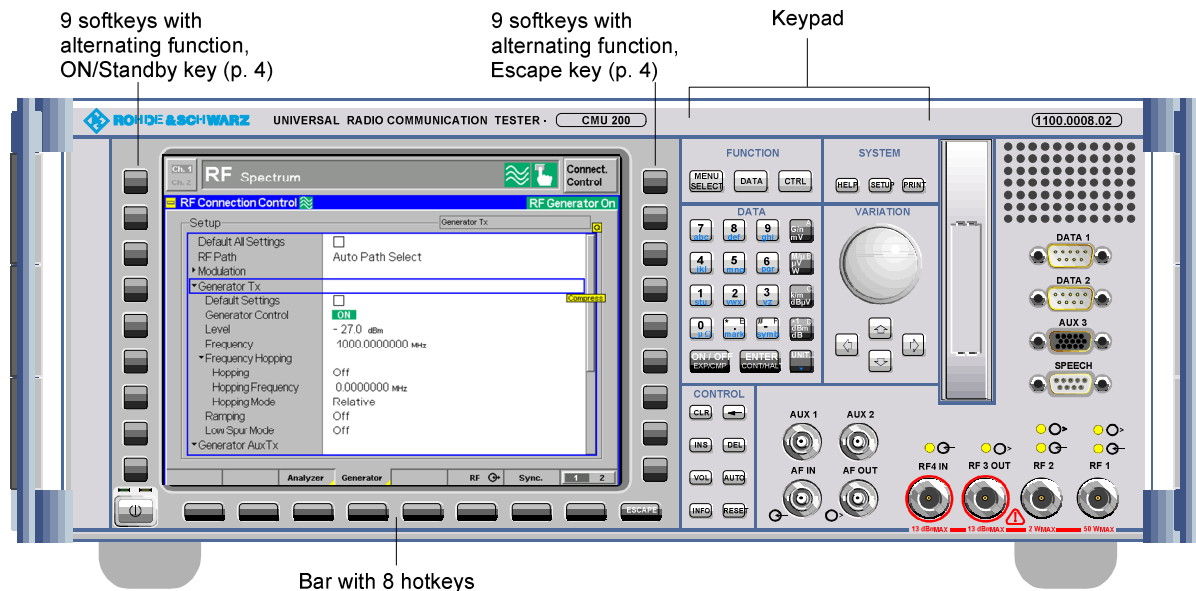

Fig. 3-1 Keys, softkeys and hotkeys

Rotary Knob

The rotary knob can be used in two different ways:

- It is **turned** to select entries in list fields and tables and to vary (increment/decrement) numerical and alphanumeric entries.
- It is **pressed** to expand or compress table sections (thus replacing the *ON/OFF* key), to expand pull-down lists, to open auxiliary input fields, and to confirm numerical entries or selections (thus replacing the *ENTER* key).

Front Panel Keys

The keys located in the right-hand part of the front panel are combined to form groups according to their functions. They control

- Data input and variation
- Pre-selection of the menus
- Settings of the instrument, editor, help file and output

The keys are described with their function in Chapter 1, section *Front and Rear View*.

Softkeys

Softkeys are assigned to the nine keys located both at the left and at the right edge of the screen. To simplify the display, only the softkeys which are actually assigned in a menu are indicated (see menu example in [Fig. 3-1](#)).



Selection of softkeys:

The R&S® CMU provides selectable and non-selectable softkeys. A softkey is selected by pressing the associated key.

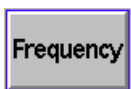

A selected softkey is highlighted by a blue frame. Softkey selection establishes a connection to settings and functions related to the softkey. These related functions can be initiated via keys (e.g. *ON/OFF*, *CONT/HALT*), or via the selected softkey itself (e.g. calling up popup menus by pressing a selected softkey again).



After the function has been terminated, or after another softkey is selected, the softkey returns to its initial state.

Softkey types and their function:

Softkeys perform definite tasks within the corresponding menus. Different types of softkeys are provided:



- Pressing the softkey (i.e. the associated key) causes an immediate response on the screen. An example is the non-selectable softkey *Connect. Control* which is used to call up a popup menu.

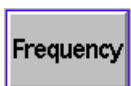

- Pressing the softkey activates a dialog box, e.g. an input field.



- The softkey is a measurement control softkey (main softkey) indicating the measurement state (*RUN*, *OFF*, *HLT*). A yellow triangle indicates that a popup menu providing configurations can be opened with the softkey (press once for selection, a second time for opening the popup).

A measurement can be started and aborted with the *ON/OFF* key (i.e. the *ON/OFF* key switches between the measurement states *RUN* and *OFF*). It can be stopped while preserving the valid results with the *CONT/HALT* key (i.e. the *CONT/HALT* key switches between the measurement states *RUN* and *HLT*; starting a measurement from the *OFF* state by means of the *CONT/HALT* key is not possible). In the *HLT* state, the instrument resources are not released; the application is still available. The formal aspects of measurement control are explained in Chapter 5.



- The softkey indicates the generator status (*ON*, *OFF*). A yellow triangle indicates that a popup menu providing configurations can be opened with the softkey (press once for selection, a second time for opening the popup).

A generator can be started and aborted with the *ON/OFF* key. The formal aspects of generator control are explained in Chapter 5, section *Measurement Control*.



The softkey toggles between two hotkey bars (corresponding to two groups of settings). The current group is indicated in large typeface in the first line of the softkey; the alternative group appears in smaller typeface next to a double triangle.

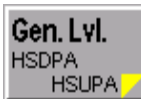

The principle of toggle softkeys may be extended to three different groups of settings.

Hotkeys

Hotkeys are assigned to the eight keys at the lower edge of the screen. Only the hotkeys which are actually assigned in a menu are indicated (see [Fig. 3-1](#)).



Selection:

A hotkey is activated by pressing the associated key. After activation it changes its frame.

Function:

Hotkeys permit to

- Change from one measurement menu/graphical measurement menu to the other
- Select tabs in the popup menu
- A yellow triangle indicates that a second version of the current tab providing additional configurations can be opened with the hotkey. The hotkey toggles between the two versions of the tab.

In the graphical measurement menu (see page [3.6](#)), hotkeys provide extended settings and can be used like ordinary function softkeys.

Operating Menus

The R&S® CMU offers a large variety of operating modes and applications. To ensure quick and easy operation, uniform menus have been implemented. They can be divided into three types:

- Measurement menu* Offers the most important settings controlling a measurement and displays the main results.
- Popup menu* Provides extended settings for a measurement menu or function group.
- Graphical menu* Displays a measurement trace together with settings and further measurement results, contains softkeys and hotkeys used to access measurement control settings.

Measurement Menus

A measurement menu provides the basic settings controlling a measurement and at the same time displays the main results. Together with the graphical measurement menus, measurement menus constitute the basic level in the operating system of the R&S® CMU. They can only be replaced by other measurement menus or graphical measurement menus. To change the menu, the hotkeys at the lower edge of the measurement menu are used.

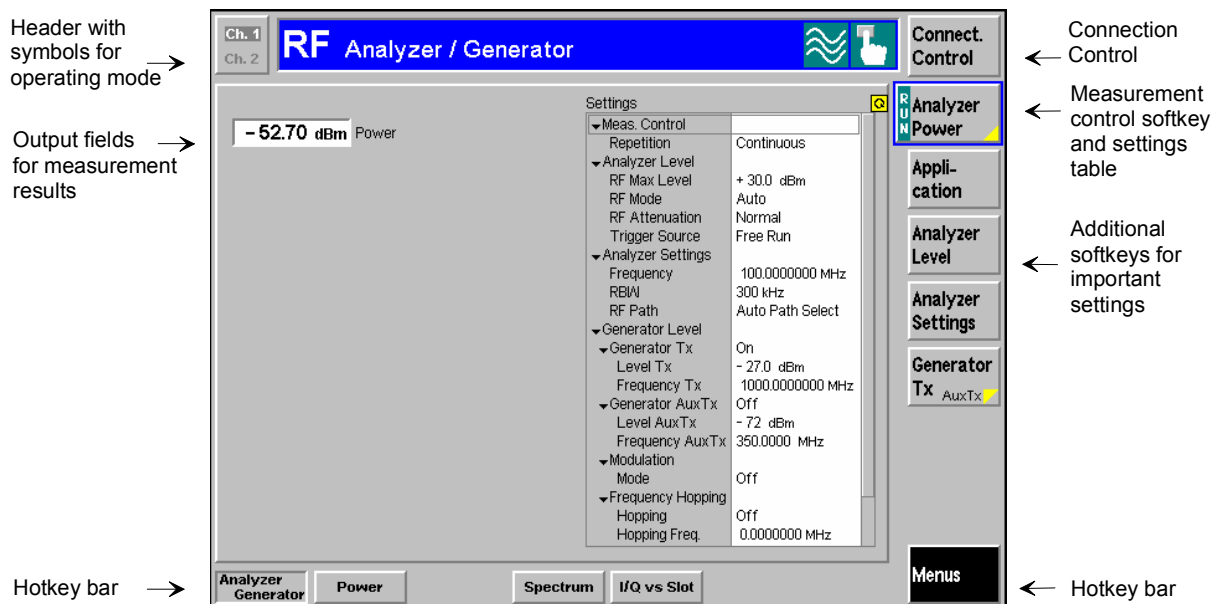

Fig. 3-2 Example of a measurement menu

Header

The header consists of the heading and the symbols for the operating mode and test mode (signalling state, if applicable in the function group).

- The *heading* briefly describes the purpose of the menu (e.g. type of settings, measurement group, function group, etc.).
- The *operating mode*, i.e. the type of operation/control of the R&S® CMU, is indicated by the symbols at the right edge of the header. The following operating modes are available:



Manual control



Remote control via GPIB (IEEE)-bus



Remote debug mode (activated in the *Setup – Remote* tab)

- The *function group* is indicated to the left of the operating mode:



RF measurements



Audio Analyzer and Generator (with option CMU-B41)

In network test applications, the *signalling states* that are specific to the applications are indicated. The corresponding icons are discussed in the relevant manuals (see *GSMxxx-MS* etc.).

General settings



The *Connect. Control* softkey is located to the right of the header of each measurement or graphical measurement menu. This softkey opens a popup menu defining the input and output connectors, the external attenuation, the reference frequency as well as many network-specific settings.

In the *Signalling* test mode of many network options, the *Connection Control* menu is also used to set up and terminate a connection between the R&S® CMU and the DUT.

The *Connection Control* menu also contains the input path and the trigger settings for the current function group and signalling state.

Measurement control softkey



The measurement control softkey (main softkey) controls the measurement application and indicates its state (*RUN* | *HLT* | *OFF*); see section [Softkeys](#) on p. 3.1 ff. Its labeling corresponds to the menu heading. For large measurement groups that are subdivided into several applications, the labeling indicates the current application.

The hotkey bar associated with the measurement control softkey provides parameters to define the scope of the measurement (statistical settings).

Pressing the measurement control softkey twice opens a popup menu providing measurement-specific settings.

Softkeys for important settings



The softkeys below the measurement control softkey provide groups of important measurement settings. Each softkey activates an associated hotkey bar. An active softkey is displayed in inverse video.



The *Menus* softkey displays all measurements in the function group, so it is possible to change from one measurement to another.

Hotkeys



If one of the softkeys is activated, the hotkeys below the test diagram provide sub-functions for this softkey.



If the *Menus* softkey is activated, the hotkeys change between the various measurement groups of the current function group.

Popup box



Popup boxes are associated with all hotkeys that require a selection or input of parameters. These popup boxes are operated like input fields in the measurement menu (input of numbers and characters) or list fields (selection from a range of alternative settings).

Popup boxes are closed when the calling hotkey is pressed again or when another popup box is opened. They remain open when another softkey is selected, so it is possible to easily test the effect of repeated changes of a parameter.

Settings table

| Settings | |
|-----------------|------------|
| Meas. Control | |
| Repetition | Continuous |
| Statistic Count | 1 sweep |
| Analyzer Level | |
| RF Max Level | + 30.0 dBm |
| RF Mode | Auto |
| RF Attenuation | Normal |
| Trigger Source | Free Run |

The *Settings* table in the right half of the menu gives an overview of the current measurement settings. The entries vary with the measurement and measurement applications. The rotary knob scrolls and expands the *Settings* table.

Graphical Measurement Menus

The R&S® CMU displays arrays of measurement results in the form of two-dimensional diagrams. In order to obtain additional space for the test diagram, no settings table is displayed. The header and the functionality of the softkeys and associated hotkeys is identical to the measurement menu; see section [Measurement Menus](#) on page 3.4.

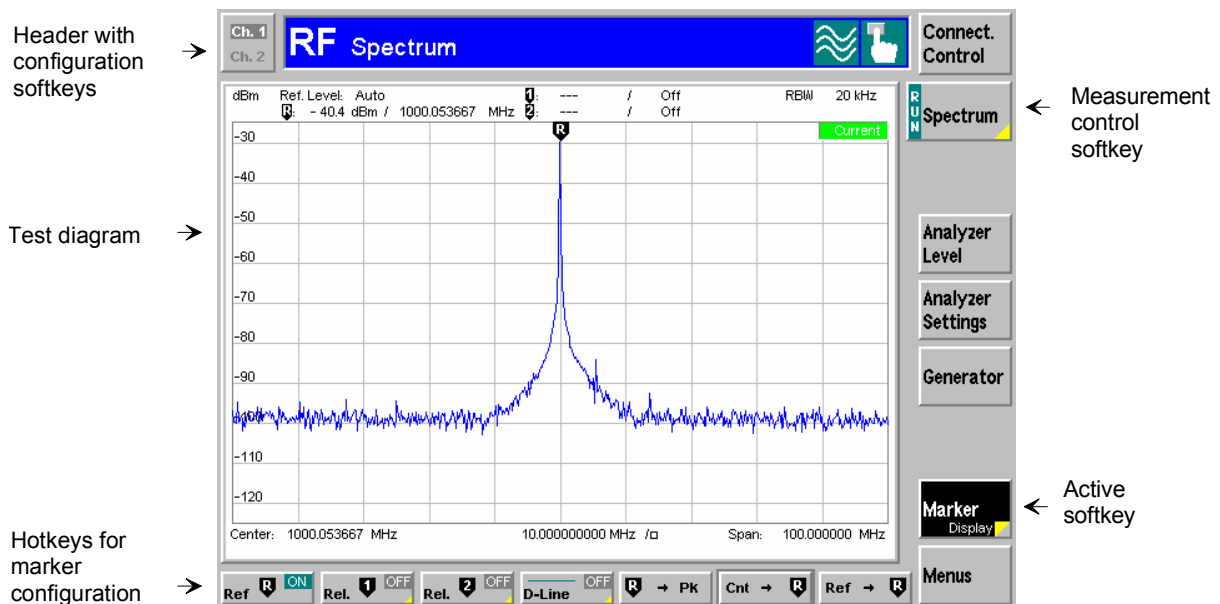

Fig. 3-3 Example of graphical measurement menu

Popup Menu

Popup menus extend the functionality of a measurement menu. They are assigned to the configuration softkey *Connect. Control* as well as to all measurement control softkeys in a measurement menu that are marked by a yellow triangle at the bottom right. They may be divided into several tabs that are selected via hotkeys in the measurement menu.

The popup menu *Connection Control* is activated by pressing the associated softkey. Popup menus which configure a measurement are activated by pressing the measurement control softkey twice (selection of softkey and subsequent opening of popup menu). A popup menu is closed by means of the *ESCAPE* key or by pressing the calling softkey again.

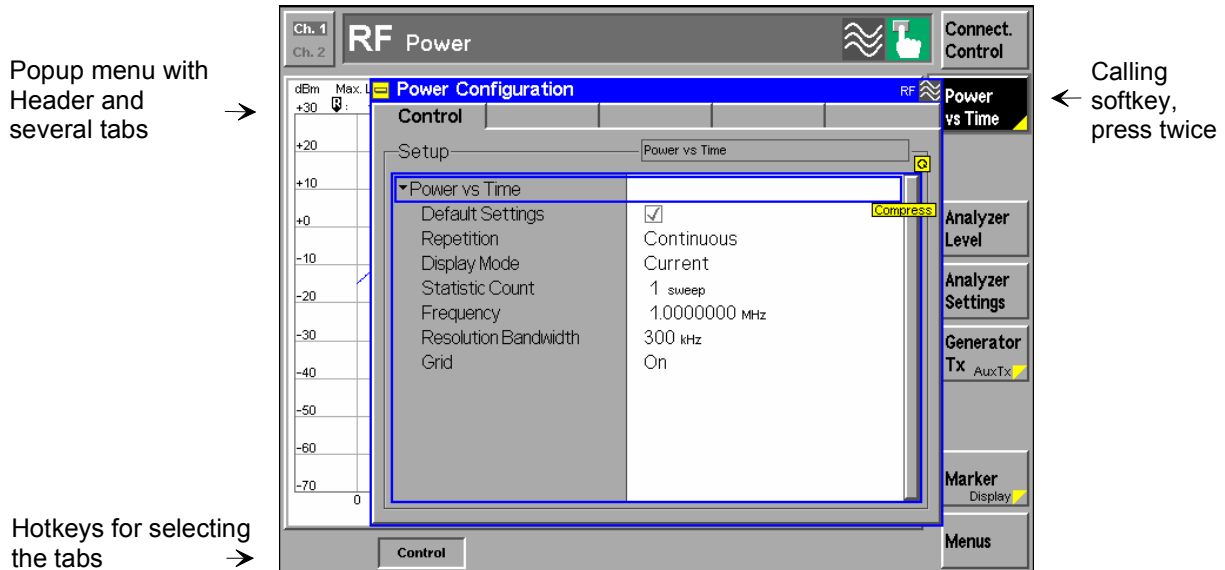

Fig. 3-4 Example of a popup menu

Header

The header consists of

- The heading (*<name of the measurement group> Configuration*; the function group is indicated on the right in small characters),
- The symbol for the signalling state on the right. See section [Measurement Menus](#) on page 3.4.

Tabs

Popup menus come without tabs (1 single window) or with several tabs.

The tabs may contain input fields, select fields, command and on/off switches (check boxes). Various fields can be combined to form groups (panels).

(Expanding) menu tables

Configuration settings in popup menus are often arranged in tables. If a table provides a large number of settings, these are usually grouped under several header lines marked by a black triangle. The items belonging to a group can be shown (expanded, triangle points down) and hidden (compressed, triangle points to the right) by selecting the corresponding header line and pressing the *ON/OFF* key or the rotary knob.

Operation of Popup Menus

The following table provides an overview of the operation of popup menus.

Table 3-1 Operation of popup menus

| Action | Operation via keys |
|--------------------------------|---|
| Open menu | Press the softkey twice (selection plus opening of menu), press only once in the case of <i>Connect. Control</i> |
| Select tabs dialog elements | Press hotkey softkeys (<i>Connect. Control</i>), cursor keys ←→↑↓ |
| Edit fields | Keys ON/OFF, ENTER, number and unit keys, rotary knob, see section Dialog Elements in the Menu on page 3.9. |
| Edit table entries | Keys ON/OFF, ENTER, number and unit keys, rotary knob, see section Dialog Elements in the Menu on page 3.9. |
| Quit and close menu | Any assigned softkey / ESCAPE key |

Dialog Elements in the Menu

This section describes the various types of dialog fields and the procedure for the input of values and parameters.

In many input or select field types, a selection made must be confirmed using the *ENTER* key. The cursor can be freely shifted over these fields; only after confirmation is the setting transferred to the instrument software.

In the case of select fields without confirmation, settings take effect immediately with the cursor selection.

Input Fields

An input field (editor) is a white, rectangular area on the screen which permits numbers or characters to be entered. Input fields are available both in measurement and in popup menus. In graphical measurement menus, the input fields are popup windows which can be called up by means of hotkeys while the instrument is in the function mode.

Note: *The easiest and quickest way to enter numbers or characters is by means of an external keyboard that is connected to the KEYBOARD connector at the rear of the R&S® CMU (see Chapter 1). Alternatively, follow the directions given in the next two sections.*

Input of Numbers

Input fields for numerical values are activated by pressing the respective softkey. Numerical values can either be varied using the rotary knob (by incrementing/decrementing individual digits) or directly entered via the numerical keypad (*DATA*) on the front panel or an external keyboard. To this end, the insert and overwrite mode is available. It may be necessary to confirm the input for transfer to the instrument hardware.

In the following, the most important possible inputs using the rotary knob or the numerical keys will be described.



Activating an input field and a digit

- To activate the input field press the associated softkey.

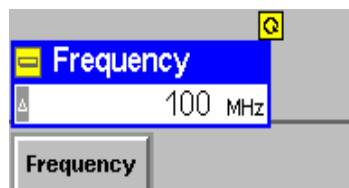

The input field appears with a blue frame. The symbol for the rotary knob appears at the top right of the input field.

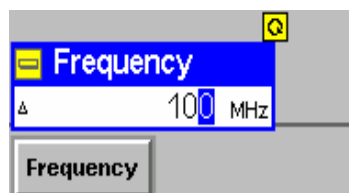

The input field is in start mode, indicated by a small white triangle on a gray background. From the start mode, it can be switched to either insert or overwrite mode.



Input using the rotary knob – Overwrite mode

- In the start mode, turn the rotary knob to activate the overwrite mode and vary the last digit of the current number.
- Use the left  or right  cursor key to switch between the decimal places of the indicated number.
- Increment/decrement the active digit by turning the rotary knob.

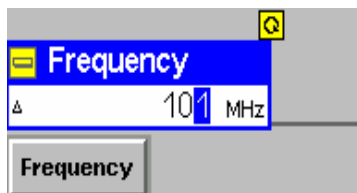

The individual digits can be varied without restriction. Incrementing a “9” produces 0 and causes the next higher digit to be incremented by 1. The editor behaves analogously when a “0” is decremented.

An *Enter* symbol at the bottom right of the input field indicates that the current value has yet to be written to the R&S® CMU software.

- Confirm the entry and terminate the input using the *ENTER* key or by pressing the rotary knob or another softkey or ...
- Press *ESCAPE* to discard the entry.

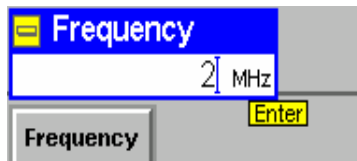

Input using the numerical keypad – Insert Mode

- In the start mode, type one of the number keys of the numerical keypad.

The previous numeric value of the editor is completely replaced. The R&S® CMU changes to the insert mode characterized by a cursor symbol. Further digits are inserted to the left of the cursor.

- Entries made in insert mode via the numerical keypad must always be confirmed using the *ENTER* key or by pressing the rotary knob.

Further control keys

The keys of the *CONTROL* group extend the functions of numerical input.

- Use the **INS** (*insert*) key to change between the modes *insert* and *overwrite*.

In the insert mode, the cursor appears in the input field.

- Use the **←** (*backspace*) key to delete the character to the left of the cursor (in insert mode).
- Use the **DEL** (*delete*) key to delete the highlighted character (in overwrite mode) and the digit right from the cursor key (in insert mode).
- Use the **CLR** (*clear*) key to delete all characters.

Confirming/discarding the input

The behavior of the editors depends on whether the values were entered in the insert or in the overwrite mode:

- If only the overwrite mode was used to define the input value no confirmation is necessary. The input value is valid as soon as another softkey or hotkey is pressed.
- If the insert mode is used, or if it was used before swapping over to the overwrite mode, the input must be confirmed with the *ENTER* key or by pressing the rotary knob. By pressing *ESCAPE* or another softkey, the input will be discarded and the previous value restored.

If the number entered conflicts with the resolution of the R&S® CMU, it will be rounded to the maximum number of digits allowed.

Error message during input

If the value defined in the input field is too high or too low, a window with the error message „<numerical value> is out of range. <permissible maximum value> is limit.“ will appear together with three buttons:

- Accept* Permissible maximum value accepted for input field,
- Re-edit* New entry
- Cancel* Last valid input value is retained.

Input of alphanumerical characters

Input fields for alphanumerical characters are activated by pressing the respective softkey. Characters can be either varied using the rotary knob (by variation of individual characters in alphabetical order) or entered via the numerical keypad (*DATA*) on the front panel or an external keyboard. The input must be confirmed using the *ENTER* key in order to be transferred to the instrument hardware. The input is terminated upon confirmation.

The table below shows the assignment of the numerical keys.

Table 3-2 Assignment of numerical keys and alphanumeric characters

| Key | Character (upper case) | Character (lower case) |
|----------|------------------------|------------------------|
| 7 abc | A B C 7 Ä Æ Å Ç | a b c 7 ä æ å ç |
| 8 def | D E F 8 É | d e f 8 é è |
| 9 ghi | G H I 9 | g h i 9 ì |
| 4 jkl | J K L 4 | j k l 4 |
| 5 mno | M N O 5 Ñ Ö | m n o 5 ñ ö ò |
| 6 pqr | P Q R 6 | p q r 6 ß |
| 1 stu | S T U 1 Ü | s t u 1 ü ù |
| 2 vwx | V W X 2 | v w x 2 |
| 3 yz | Y Z 3 | y z 3 |
| 0 _µΩ | space µ Ω 0 £ \$ ¥ € | space µ Ω 0 £ \$ ¥ € |
| . * mark | \ _ * , ; ; ' " ? () | \ _ * , ; ; ' " ? () |
| - # symb | - # / () < = > % & | - # / () < = > % & |
| UNIT.. ↓ | Upper / lower case | Upper / lower case |

The full character set may be restricted if required for reasons of compatibility (e.g. for input fields defining file names).

The most important possible inputs using the rotary knob or the digital keys are described in the following.

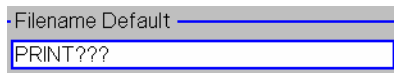

Activating the input field and auxiliary editor

- To activate the input field press the associated softkey. If the softkey is assigned to a panel with several controls, use the cursor key to select the desired input field.



- Press or turn the rotary knob to open the auxiliary editor associated with the input field.

The auxiliary editor is used to edit a name that may extend over several lines. The cursor is placed at the end of the current character string.



Input using the numerical keys

- Press one of the numerical keys to write a character to the current cursor position.



- To change a character, position the cursor to the desired character using the left or right cursor key and overwrite the character.



- Press a numerical key repeatedly to access the different characters assigned to it (see assignment of keys in [Table 3-2](#)).

- Press the *UNIT* key plus a numerical key to switch to the upper case character set.

- Confirm the input using the *ENTER* key.

If the syntax specified is invalid (e.g. an invalid file name was defined), an error message of the type *Filename syntax <name> is invalid Cancel / Re-edit* is displayed. Otherwise the edited character string is written to the input field in the menu.

- Press another softkey or change the menu to close the auxiliary editor.

Input using the rotary knob

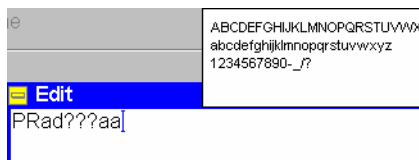

- After opening the auxiliary editor, turn the rotary knob in either direction. A list of all valid (upper and lower case) characters for the current input field is opened.

- Turn the rotary knob and select the character to be written to the cursor position in the auxiliary editor. Selected characters are shown in inverse video.

- Press the rotary knob to confirm your selection and enter the selected character into the auxiliary editor.



- Select a character and turn the rotary knob to increment/decrement the character in alphabetical order.

Insert/overwrite



The keys of the *CONTROL* group extend the functions of character input.

- Use the (*insert*) key to change between the modes *insert* and *delete*.

In insert mode, the cursor appears in the input field.

- Use the  (*backspace*) key to delete the character to the left of the cursor.
- Use the  (*delete*) key to delete the inversely displayed character (in overwrite mode).
- Use the  (*clear*) key to delete all characters.

Confirming/discarding the input

- Use the  (*ESCAPE*) key or another softkey to abort character input and deactivate the input field and the softkey.
- Use the  (*ENTER*) key to confirm the character input.

If the syntax specified is invalid (e.g. an invalid file name was defined), an error message of the type *Filename syntax <name> is invalid Cancel / Re-edit* is displayed. Otherwise the edited character string is written to the input field in the menu.

- Press another softkey or change the menu to close the auxiliary editor.

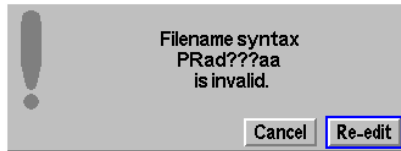

Select Fields in Popup Menus

Various types of fields permit to select one or several settings out of a number of given options. The desired settings are to be marked; the selection is to be confirmed using the *ENTER* key, if required.





Popup menus may or may not contain softkeys; they contain input or select fields which can be combined to form panels or groups and tables. Select fields and tables in the popup menu can be controlled intuitively using the cursor keys    . The following overview applies to all field types.

Table 3-3 Operation of select fields

| Action | Key operation |
|---|--|
| Select field group / list | Cursor keys, softkey |
| Select single field, command button, or line in list field or table | Rotary knob |
| Switch on or off single field or line in list field | <i>On/Off</i> key, in the case of buttons also rotary knob, <i>ENTER</i> key |
| Confirmation (if required) | <i>ENTER</i> key |



Pull-down list fields

are compressed into one line in the popup menu.

- Press the associated softkey (if available) or use the cursor keys to select the list. Press *ENTER* or the rotary knob to expand the list (expand in upward or downward direction depending on the space available).
- To select a line use the rotary knob.
- Press *ENTER* to confirm your selection and close the list.
- Press *ESCAPE* or another key to discard your selection and close the list.

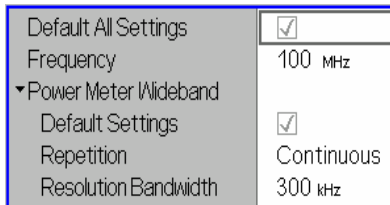

(Expanding) menu tables

usually cover the whole popup menu or tab so they are active as soon as the menu is opened. The right-hand fields of a menu table (white background) can be edited. Table lines without any input option but with a black triangle are headers with several sub-items that can be expanded or compressed:

- To move the control frame to a line use the rotary knob or the cursor up/down keys.
- Press *ENTER* to select a line and start editing. Numerical values can be entered as described in section [Input of Numbers](#) on page 3.9. Alternative settings can be selected using the rotary knob.
- Press *ENTER* to confirm an entry and quit the table line.
- Press *ESCAPE* or another key to discard your entry and release the table line.
- Select a header line and press the rotary knob to expand (show) or compress (hide) a table section. Press the *ON/OFF* key to expand all compressed tables in the menu.

Measurement Control

This section gives a brief survey of the R&S[®] CMU's measurement control using the function group *RF Non Signalling* as an example. This includes a discussion of the different measurement modes and measured quantities. Settings and measurement parameters frequently encountered are explained from a general point of view.

The formal aspects of measurement control are discussed in more detail in Chapter 5 (*Remote Control – Basics*).

The menus of the graphical user interface can be arranged in different ways. According to their tasks, they form the following groups:

- The function groups *RF*, *Audio*, *GSM900-MS*, *GSM1800-MS* and *GSM1900-MS*, etc. The *RF* function group is supplied with the firmware for the R&S[®] CMU base system. The function groups for network test applications are optional and described in separate operating manuals.
- The two signalling modes *Signalling* and *Non Signalling*. The signalling properties are specific to the individual networks and devices under test. In the function group *RF* only *Non Signalling* measurements are provided.
- General configurations (*Connection Control*), configurations specific to a measured quantity (*Power Configuration*, *Modulation Configuration* etc.), and menus to display the results of the measurement (*Power*, *Modulation* etc.).

In a more formal sense, the R&S[®] CMU uses measurement menus, popup menus, table menus, and graphical measurement menus and dialog windows of various sizes. This aspect is discussed in the preceding sections.

Configurations

The R&S[®] CMU offers a wide range of settings for input and output signals and measurements. Configurations either refer to the whole function group (*Connection Control*) or to a particular measurement.

Connection Control

The *Connect. Control* softkey is located on the right side of the title bar of each measurement and graphical measurement menu. It opens a popup menu with several tabs to configure

- The analyzer settings and input path configuration (*Analyzer*)
- The RF generator (*Generator*)
- The RF and possibly the AF connectors to be used and the external attenuation (*AF/RF* ⊕)
- The reference signal and system clock (*Sync.*)
- The trigger settings (*Trigger*)

All settings made in the *Connect. Control* menu apply to the whole function group and signalling mode.

Configuration of measurements

A *Configuration* popup menu offering specific settings is assigned to most measurement groups (see e.g. the *Power* and *Spectrum* measurements in the *RF* function group and the *Multitone* measurement in the *Audio* function group). The *Configuration* menu also provides general parameters that can be defined independently in many measurement groups:

- The repetition mode, the stop condition, the statistic count and the

display mode for the measurement (*Control*)

- Tolerances for the measured quantities (*Limits, Limit Lines*)

These settings are explained in more detail below (see section [General Settings](#) on page 3.17 ff.). For a detailed explanation refer to the manuals for network tests listed before tabbed divider no. 1.

Measurement Groups

Measurement results are indicated in two different ways:

- Discrete values and parameters are displayed in output fields, lists and tables. In remote control, these results are referred to as scalars.
- Measurement curves (traces) are displayed in a Cartesian coordinate system, the time, frequency or another continuous parameter forming the x-axis scale. Power results are usually plotted in semi-logarithmic diagrams. Relatively small sets of test points are generally viewed in a bar graph. In remote control, results of this type are referred to as arrays.

While the measurement is running in repetition mode *continuous* (see page 3.17), the indicated results are constantly updated. Each function group and measurement mode comprises a particular selection of measurement groups. The measurements belonging to function group *RF (Non Signalling)* and *Audio* are shown in the following table.

Table 3-5 Measurements in function group *RF (Non Signalling)*

| Menu | Function |
|---------------------------|---|
| Analyzer/Generator | Shows the settings for the signals generated and analyzed by the instrument, the generator status, and the state of the RF analysis. Moreover the current analyzer power can be measured with different filters. |
| Power | Shows the trace of the measured RF power in oscillographic representation, i.e. as a function of time. The maximum level and frequency of the input signal is indicated in addition. Single points of the trace may be evaluated using graphical tools (markers, D-Line). |
| Spectrum | Shows the trace of the measured RF power in spectral representation, i.e. as a function of the frequency. Parameters of the measurement are indicated in addition. Single points of the trace may be evaluated using graphical tools (markers, D-Line). |
| I/Q vs. Slot | Measures the averaged I/Q amplitudes in a sequence of consecutive measurement steps of configurable length. |

Table 3-7 Measurements in function group *Audio* (with option R&S® CMU-B41)

| Menu | Function |
|---------------------------|--|
| Analyzer/Generator | Generates a single-tone sinusoidal audio signal and measures the DC and AC voltage and the Total Harmonic Distortion and Noise of a single-tone audio signal. |
| Multitone | Generates a composite audio signal consisting of up to 20 individual fixed-frequency tones with configurable frequency and level. An audio signal containing the same tones can be analyzed in a single measurement and displayed in a bar chart. A limit check is provided for all results. |

| Menu | Function |
|------|---|
| THD | Provides a single-frequency audio test signal with adjustable power and very low harmonic distortion and measures the AF power at the generator frequency (1st harmonic labeled d1) and at the 2 nd , 3 rd ... 9 th harmonics. These results yield the Total Harmonic Distortion, defined as the ratio of the summed up power of the 2 nd , 3 rd ... 9 th harmonics to the power of all harmonics including the fundamental signal. |

General Settings

A number of settings can be made in several of the configuration menus assigned to the individual measurement groups. In combination, these settings define the scope of each measurement, i.e. the number of results acquired and the type of results displayed. The following brief overview is intended to avoid confusion of terms.

Application *Applications* are different measurements belonging to the same measurement group. They effectively split up a measurement group into various related subgroups which can be configured separately.

They are selected via the *Application* softkey in the measurement menus.

Statistic Count / Statistics Cycle The statistic count is equal to the integer number of evaluation periods which form one statistics cycle. The definition of an evaluation period changes from one measurement to another:

- The evaluation period for *Power* and *Spectrum* measurements (function group *RF*) corresponds to the duration of a sweep.
- The evaluation period for *Multitone* measurements (function group *Audio*) corresponds to the time until the system has settled and a valid result is available.
- In all digital radio communication systems (GSM, TDMA, CDMA, ...), the information is transmitted in periodic timeslots of equal length. These slots provide natural evaluation periods for all measurements on digital network tests. See the relevant manuals for more specific information.

Depending on the *repetition mode* (see below), a measurement may extend over one or several statistics cycles. The *statistic count* is set in the *Control* tab of the configuration popup-menus assigned to each measurement group. If this parameter is omitted, a statistics cycle always comprises just one evaluation period.

Repetition Mode The *repetition mode* defines how many statistics cycles are measured if the measurement is not stopped by a limit failure (see stop condition *On Limit Failure* below). Two modes are available for all measurements:

Single Shot The measurement is stopped after one statistics cycle

Continuous The measurement is continued until explicitly terminated by the user; the results are periodically updated

A third repetition mode is available in remote control:

Counting Repeated single shot measurement with a fixed number of statistics cycles

The *repetition mode* is set in the *Control* tab of the measurement configuration popup-menus.

Note: In contrast to other instrument settings, the repetition modes in manual and remote control are independent and do not overwrite each other. The default repetition mode in manual control is Continuous (observe results over an extended period of time), the default mode in remote control is Single Shot (perform one measurement and retrieve results).

Stop Condition

For measurements providing a limit check, two stop conditions can be selected:

None The measurement is performed according to its repetition mode, regardless of the measurement results.

On Limit Failure The measurement is stopped as soon as one of the limits is exceeded, regardless of the repetition mode set. If no limit failure occurs, it is performed according to its repetition mode.

Some other stop conditions are defined for network tests. See the relevant manuals for more information.

The *stop condition* is set in the *Control* tab of the measurement configuration popup-menus.

Display Mode

In graphical measurement diagrams, the *display mode* defines which of the measured and calculated curves (traces) is displayed if the measurement extends over several evaluation periods. In general, traces are evaluated at a set of fixed, equidistant test points (samples). After n evaluation periods, n measurement results per test point have been acquired. After a single shot measurement extending over c periods, c measurement results per test point have been acquired.

Current The current burst, i.e. the last result for all test points, is displayed.

Minimum At each test point, the minimum value of all bursts measured is displayed.

Maximum At each test point, the maximum value of all bursts measured is displayed.

Average At each test point, a suitably defined average over all bursts measured is displayed; see paragraph on *Calculation of average quantities* below.

Note the difference in the calculation of *Average* on one hand, *Minimum*, *Maximum* and *Max./Min.* on the other hand, if the measurement extends over more than one statistic count (repetition mode *Continuous*, measurement time longer than one statistic count).

After evaluation of the different traces, the burst power is logarithmized and plotted in a semi-logarithmic diagram.

The *display mode* is set in the *Control* tab of the measurement configuration popup-menus.

Calculation of average quantities

The *Average* traces in the *Power* and *Spectrum* menus are obtained as follows:

Let c be the number of evaluation periods forming one statistics cycle (one *statistic count*) and assume that n periods have been measured since the start of the measurement. In calculating the *Average* trace, the following two situations are distinguished:

$n \leq c$ Single shot measurement or continuous measurement during the first statistics cycle: At each test point, *Average* trace no. n is calculated from *Average* trace no. $n - 1$ and *Current* trace no. n according to the following recurrence:

$$Avg(n) = \frac{n-1}{n} Avg(n-1) + \frac{1}{n} Curr(n) \quad (n = 1, \dots, c)$$

Equation 3-1

The *Average* trace represents the arithmetic mean value over all n evaluation periods measured.

 $n > c$

Continuous measurement after the first statistics cycle: At each test point, *Average* trace no. n is calculated from *Average* trace no. $n - 1$ and *Current* trace no. n according to:

$$Avg(n) = \frac{c-1}{c} Avg(n-1) + \frac{1}{c} Curr(n) \quad (n > c)$$

Equation 3-2

The formulas hold for $n = 1$ where the average trace becomes equal to the current trace (statistics off). Scalar quantities are averaged in analogy to *Average* traces.

Note: *Some network tests (e.g. WCDMA) use a different prescription to calculate the average traces. See the relevant manuals for more information.*

Contents

| | |
|---|-------------|
| 4 Functions and their Application..... | 4.1 |
| Startup Menu..... | 4.1 |
| On-Screen Help (HELP Key) | 4.3 |
| Reset of Instrument Settings (RESET Key) | 4.3 |
| Print Menu (PRINT Menu) | 4.5 |
| Menu Select..... | 4.7 |
| Popup Menu Setup | 4.9 |
| Printer Settings (Setup – Print)..... | 4.9 |
| Remote-control Settings (Setup – Remote) | 4.11 |
| Remote Debug Mode | 4.14 |
| Serial Interfaces (Setup – Comm.)..... | 4.15 |
| Hardware and Software Options (Setup – Options)..... | 4.16 |
| Time Settings (Setup – Time) | 4.19 |
| Acoustic Signal and Keyboard (Setup – Misc.) | 4.20 |
| TCP/IP Address Settings (TCP/IP) | 4.21 |
| System Information (Info) | 4.25 |
| Selftest (Maintenance) | 4.26 |
| Data Handling (Data) | 4.29 |
| Saving Configurations (Data – Save)..... | 4.29 |
| Loading Saved Configurations (Data – Recall) | 4.32 |
| Layer 3 Message Log (Data – Logging) | 4.33 |
| Transfer and Evaluation of Log Files | 4.35 |
| File Manager (Data – Arrange)..... | 4.37 |
| RF Measurements (RF) | 4.41 |
| Analyzer/Generator Menu | 4.41 |
| Test Settings | 4.43 |
| Measurement Results | 4.45 |
| Analyzer/Generator Configuration..... | 4.46 |
| Power vs. Time Measurement | 4.49 |
| Measurement Menu (Power) | 4.49 |
| Test settings..... | 4.50 |
| Measurement Results | 4.53 |
| Measurement Configurations (Power Configuration)..... | 4.54 |
| Spectrum Measurement..... | 4.57 |

| | |
|---|-------------|
| Measurement Menu (Spectrum) | 4.57 |
| Test settings | 4.58 |
| Measurement Results | 4.63 |
| Measurement Configurations (Spectrum Configuration) | 4.64 |
| I/Q vs. Slot Measurement..... | 4.66 |
| I/Q vs. Slot Multiple Sub sweep Measurements | 4.69 |
| Connection Control..... | 4.73 |
| Analyzer Settings (Connection Control – Analyzer) | 4.73 |
| Softkey-Oriented Version | 4.73 |
| Table-Oriented Version | 4.74 |
| Generator Settings (Connection Control – Generator) | 4.76 |
| Softkey-Oriented Version | 4.76 |
| Table Oriented Version | 4.77 |
| Generator List Mode | 4.82 |
| RF Connectors (Connection Control – RF)..... | 4.84 |
| Frequency-Dependent External Attenuation | 4.87 |
| Reference Frequency (Connection Control – Sync.) | 4.89 |
| Trigger (Connection Control – Trigger)..... | 4.92 |
| I/Q-IF Interface (Connection Control – I/Q-IF) | 4.94 |
| Options and Extensions | 4.96 |
| Audio Option (R&S CMU-B41)..... | 4.96 |
| Analyzer/Generator Menu | 4.96 |
| Test Settings | 4.97 |
| Measurement Results | 4.100 |
| Measurement Configurations (Analyzer Configuration) | 4.102 |
| Multitone Measurement | 4.107 |
| Test Settings | 4.107 |
| Measurement Results | 4.110 |
| Measurement Configurations (Multitone Configuration)..... | 4.112 |
| Total Harmonic Distortion (THD) | 4.119 |
| Measurement Configurations | 4.120 |
| I/Q and IF Interface (Option CMU-B17) | 4.124 |
| I/Q-IF Test Scenarios..... | 4.124 |
| Application Examples..... | 4.126 |
| Bit Error Rate Measurements on Digital Receivers under Fading Conditions..... | 4.127 |
| CMU200 as I/Q Generator and RF Analyzer..... | 4.128 |
| CMU200 as RF Generator and I/Q Analyzer..... | 4.129 |
| FM Stereo Transmitter (Option R&S® CMU-K14) | 4.130 |

4 Functions and their Application

This chapter explains in detail all functions of the R&S® CMU and their application. The structure of the chapter is based on the different menu groups of the instrument. It is organized like a typical measurement session including the following stages:

1. Startup menu
2. Menu selection
3. General device configurations
4. System information and hardware diagnosis
5. General RF measurements (measurements and measurement results, configurations)
6. Optional extensions, e.g. *Audio Generator and Analyzer* (option CMU-B41) including *Audio Multitone*

In contrast to Chapter 6, *Remote Control – Commands*, the measurement and results are explained first, special measurement configurations are relegated to the end of the chapter. The description of the softkeys is followed by the remote-control commands. Similarly, the description of the commands in Chapter 6 also contains the corresponding menus of the user interface.

The description of the operating concept is to be found in Chapter 3; in addition, an overview of all menus is given at the end of Chapter 3. To find information on a particular topic please refer to the index at the end of the manual.

Startup Menu

The startup menu provides information on the instrument and the installed options. It appears for a few seconds in the display after switching on the R&S® CMU and activating the operating mode (see Chapter 1, *Switching on the Instrument/Startup Test*). While this menu is displayed, the R&S® CMU performs a startup test.

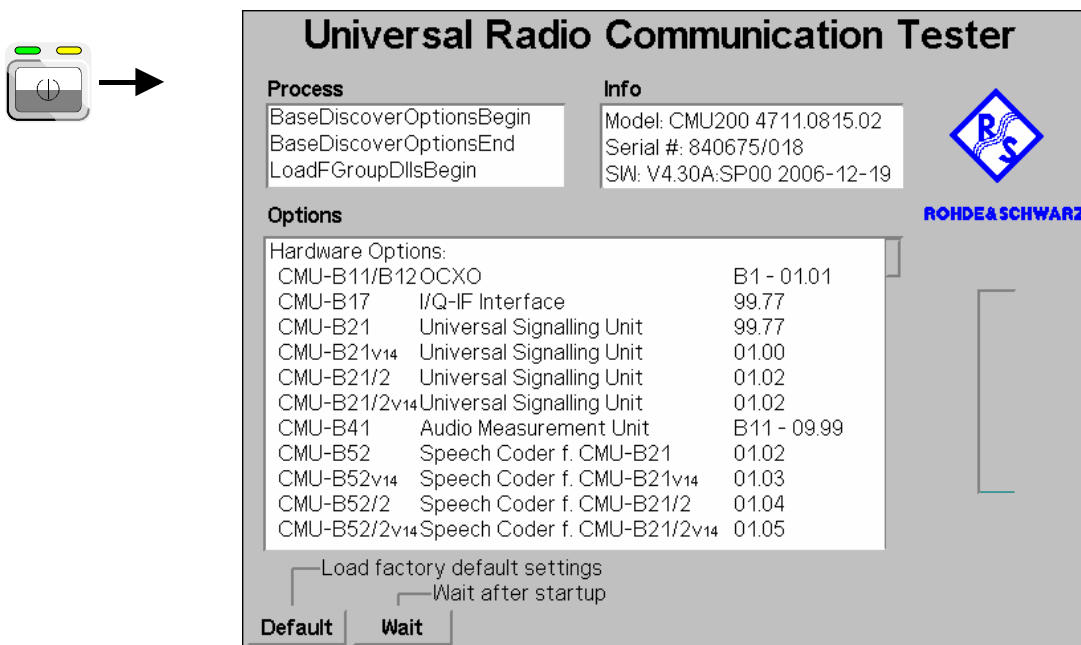

Fig. 4-1 Startup menu

Displays in the startup menu

The display windows of the startup menu provide information on

- The startup procedure (*Process*).
- Instrument model, serial number and version of the R&S® CMU base software (*Info*).
- Installed hardware and software options and equipment (*Options*). Available software options are listed with their version numbers.
- Progress of the startup procedure (*Startup bar graph*).

After terminating the startup procedure, the instrument changes to the last main menu or graphical measurement menu of the previous session.

Hotkeys

During the startup procedure, the hotkeys of the startup menu are available.

Default

The *Default* hotkey activates the default settings of the instrument for all function groups and test modes. Alternatively, a reset can be performed any time using the *RESET* key; see section [Reset of Instrument Settings \(RESET Key\)](#) on p. 4.3.

Wait

The *Wait* hotkey prevents the instrument from closing the *Startup* menu.

As a result of this, the *Wait* softkey changes to *Cont.* with the additional message *Change to last menu* displayed on top. Instead of changing to the last main menu or graphical measurement menu of the previous session the measurement can be continued by pressing a key (*Menu Select, Setup, ...*).

On-Screen Help (HELP Key)

The *Help* menu displays help on the basic menus, controls and keys. It is possible to expand and compress the topics using the *ON/OFF* key. The menu is opened via the *HELP* key (*SYSTEM* keypad).

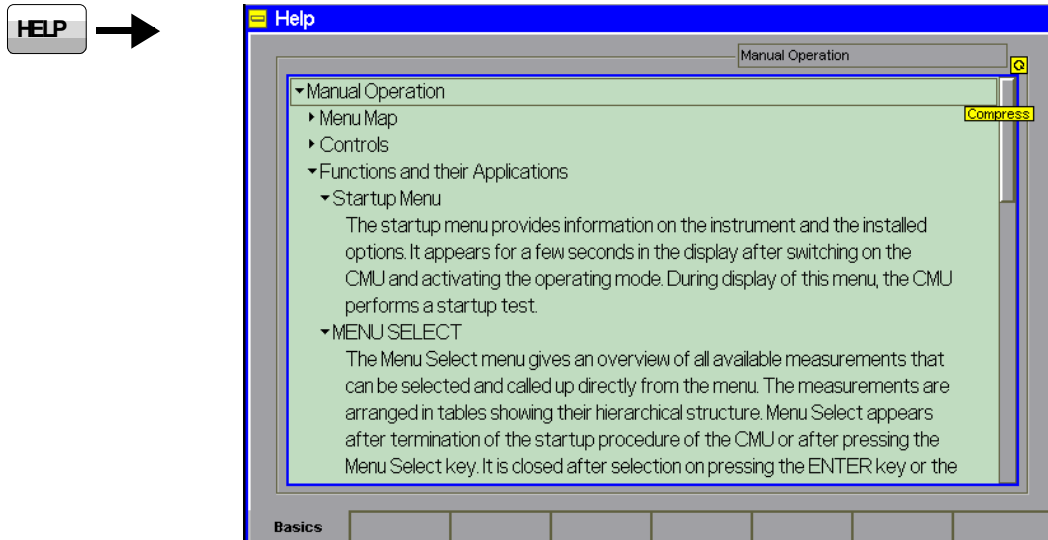

Fig. 4-2 Popup window Help

Reset of Instrument Settings (RESET Key)

The popup window *Reset* sets the instrument settings in all or some function groups and test modes to their default values. It is opened via the *RESET* key (*CONTROL* keypad).

Note: *A reset of the instrument does not necessarily mean that the current instrument settings are lost. The R&S® CMU can store the settings in a configuration file and re-use them in a later session; see section [Saving Configurations \(Data – Save\)](#) on p. 4.29..*

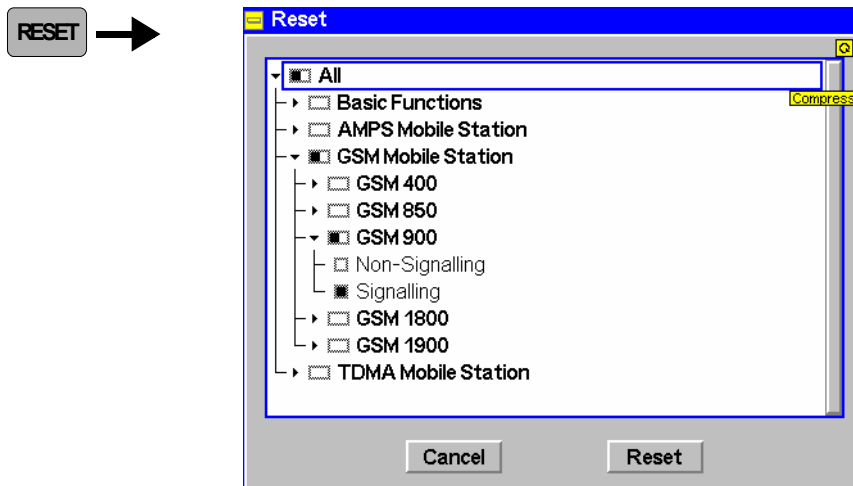





Fig. 4-3 Popup window Reset



Selection of the settings

All function groups and test modes available on the instrument are arranged in a tree view. When the popup is opened, this configuration tree is expanded and the active function group and test mode is selected.

Nodes containing subnodes (e.g. function groups containing the test modes *Non Signalling* and *Signalling*) are marked with rectangular symbols, lowest-level nodes (e.g. the individual test modes within a function group) with smaller, quadratic symbols:

-  The node is deselected
-  The node is partially selected, i.e. some but not all of the subnodes are selected
-  The entire node is selected, i.e. all of the subnodes are selected

The controls in the *Reset* window are manipulated with the roll-key, the cursor keys and the *ENTER* key:

-  Toggle between the *Cancel* and the *Reset* buttons
-  Toggle between the control buttons (*Cancel*, *Reset*) and the tree view

Roll-key Toggles between the *Cancel* and the *Reset* buttons (when turned) or activates a button (when pressed). In the tree view, the roll-key moves the control frame up and down (when turned) or expands/compresses a node (when pressed). Pressing the roll-key on a lowest-level node selects or deselects the node.

ENTER Activates a button or selects/deselects a node including all subnodes.



The *Reset* button resets all settings in the selected function groups and test modes.

A box pops up to confirm the reset. While the reset is performed, the message *Reset in progress* is displayed. All running measurements are aborted and a connection to a DUT is dropped. Then the *Reset* popup window is closed and the R&S® CMU returns to the function group and test mode that was active when the reset was initiated.

Note: *A reset of the active function group is faster because no additional software modules must be loaded. Additive function groups (e.g. an Audio function group which complements a GSM function group) are reset together with the selected function groups.*

A reset of all instrument settings can also be performed during the startup procedure; see Default softkey in section [Startup Menu](#) on p. 4.1.

The reset button restores the default values for manual control. In cases where the remote control commands use distinct default values (e.g. the repetition modes) only the manual default values are restored.

Remote control

- SYSTem:PRESet[:ALL] (base system)
- Compare: SYSTem:RESet[:ALL] (default parameters in remote control, base system)
- SYSTem:RESet:CURRent (default parameters in remote control, all function groups)



The *Cancel* button cancels the selection that has been made and closes the menu. *Cancel* is selected by default when the *Reset* menu is opened.

Remote control

—

Print Menu (PRINT Menu)

The popup window *Print* permits to print the current screen as configured in the *Print* tab of the *Setup* menu. It is called up on pressing the *PRINT* key (*SYSTEM* keypad).



The screenshot is recorded immediately after PRINT is pressed. There is no danger of losing data while selecting a destination and filename.

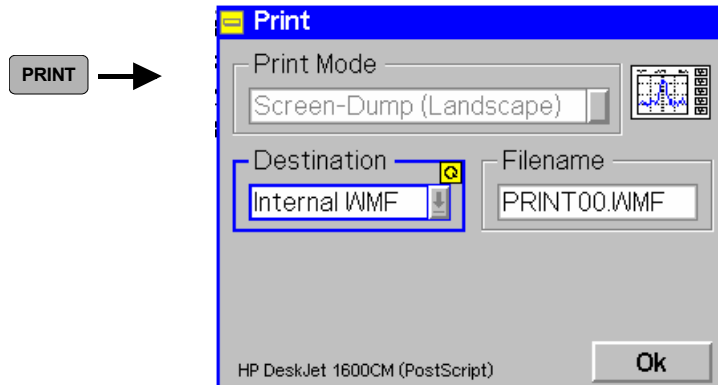

Fig. 4-4 Popup window Print

- Print Mode** The *Print Mode* select field permits to specify the data type for the output:
Screen-Dump (Landscape) Copy of the current display in landscape format
 An example of a screen-dump copy is shown in a preview to the right of the select field.
- Destination** The *Destination* select field permits to specify the output destination for the data:
- Printer* Output to external printer connected via the parallel or the serial interface. The printer is configured in the *Setup – Print* tab; see p. 4.9.
 - Internal* Storing in the current printer format to directory `Internal\userdata\print\<Dir>` where `<Dir>` is the target directory specified in the *Filename Default* input field of the *Setup – Print* tab. If `<Dir>` is not explicitly defined, the files are written to `Internal\userdata\print`.
 - Internal WMF* Storing in *.wmf format.
 - External* Storing in the current printer format to the `<Dir>` target directory (see *Internal* above) on the CF / PCMCIA card (slot 0, right-hand slot) or floppy disk (with option CMU-U61). A message box *Please insert disc ! Repeat ? Yes/No* pops up if no storage medium is inserted in the drive. To print, insert the appropriate medium and confirm with *Yes*.
 - External WMF* Storing in *.wmf format to the CF / PCMCIA card or floppy disk; see above.
- Note:** *To make processing of the generated data files easier, we recommend to use the External output destination.*

Filename If the data is to be written to a file, a file name can be specified in the *Filename* input field. By default, print files are stored with the file name defined in the *Setup – Print* tab (see p. 4.9). The question marks (??) in this default name are replaced by current numbers starting with zero (auto-increment function). If a file name used before is specified, or if a file where the question mark has been replaced by "99" is already stored in the target directory, a message box *Print: overwrite existing file Yes/No* pops up. Pressing *No* aborts the print procedure and closes the *Print* popup menu.

Note: *A third question mark in the file name extends the auto-increment function so that up to 999 print files can be stored. Keep in mind the capacity of the internal hard disk when using this feature.*

Comment The input field *Comment* contains a comment (comprising up to 160 characters) for the current output. This field is not available if a *.wmf output is generated. When the output is sent to a printer the comment is written across the upper edge of the page.

Printer format The current printer format is indicated below the *Comment* input field. To change this format, open the *Setup –print* tab (see p. 4.9) to select another printer.



The *Ok* button starts the data output and closes the *Print* menu.

To cancel the print process while preserving the current settings and close the *Print* menu press the *PRINT* key again.

Remote control
–

Menu Select

The *Menu Select* menu gives an overview of all available measurements that can be selected and called up directly from the menu. The measurements are arranged in tables showing their hierarchical structure. *Menu Select* appears after termination of the startup procedure of the R&S® CMU or after pressing the *Menu Select* key. It is closed after selection on pressing the *ENTER* key or the *MENU SELECT* key again. The *ESCAPE* key discards the current selection.

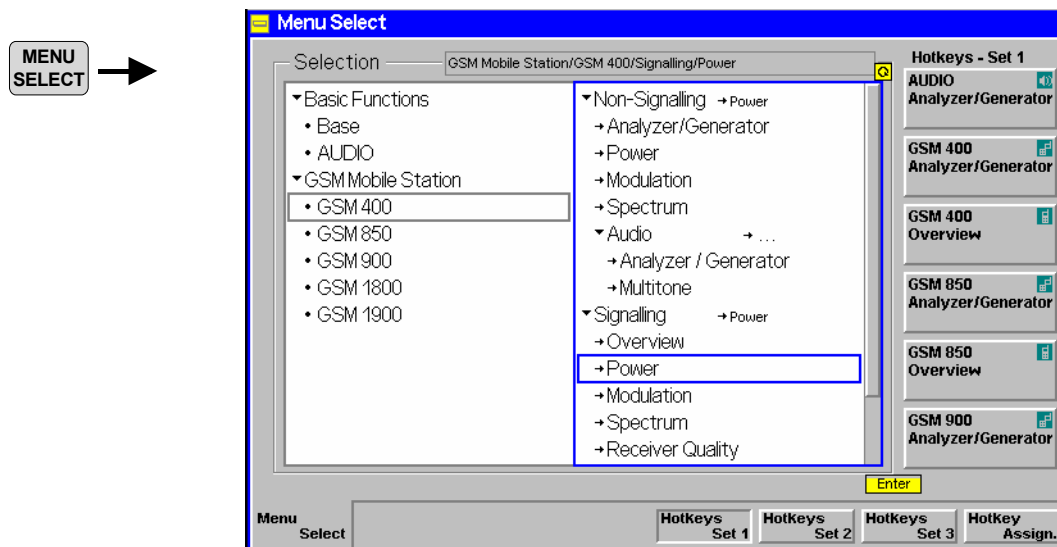

Fig. 4-5 Menu Select

Selection table: function groups The left half of the *Selection* table contains all function groups available on the instrument. The R&S® CMU performs general RF measurements accessible via the function group:

RF RF measurements, see below in this chapter

If equipped with option CMU-B41, it provides AF measurements via the function group:

Audio Audio generator and analyzer including multitone measurements, see below in this chapter

It is a versatile measuring instrument for a large variety of digital and analog network tests (all of them are optional, see separate manuals). For a complete list of deliverable network tests please refer to the data sheet.

Selection table: test modes and menus When a function group is selected, the measurements within this group are displayed in the right half of the table. A measurement generally consists of measurement menus and specific configuration menus. A complete graphical overview of all menus of the R&S® CMU basic system and the function groups *RF* and *Audio* can be found at the end of Chapter 3 in this manual.

Most of the optional network test function groups are divided into two independent test modes:

Non Signalling Module tests; measurements without transmission of signalling parameters and call setup.

Signalling Measurements with signalling and call setup to the device under test.

The test modes form the header lines of expandable table sections. A measurement may be available in both test modes of a function group, therefore, to uniquely define a measurement, it is necessary to specify its name, the test mode (if applicable) and the function group.

Example

In *Fig. 4-5*, the *Power* measurement is selected. This measurement belongs to the *Signalling* test mode in function group *GSM400-MS*. Another *Power* measurement belongs to the *Non Signalling* test mode of the same function group.

| |
|-------------------|
| Hotkey Assign. |
|-------------------|

The *Hotkey Assign.* hotkey activates the assign mode used to assign a softkey to the function group, signalling mode and measurement menu currently selected.

The six softkeys of the *Menu Select* menu belonging to *Hotkeys Set 1* have a default assignment. In normal mode, each hotkey gives direct access to the menu assigned to it. Another two sets, each containing six softkeys, can be accessed by pressing the *Hotkeys Set 2* or *Hotkeys Set 3* hotkeys, respectively.

In the assign mode, the *Hotkey Assign.* softkey turns into *Exit Assign.* softkey and *Hotkey Assignment* is displayed in the header of the *Menu Select* menu.

- To assign a softkey (or to change the current assignment), select the desired function group, mode and menu, and press *Hotkey Assign.* followed by the softkey. Press *Exit Assign.* to quit the assign mode.
- To cancel a hotkey assignment, press *Hotkey Assign.* followed by the *DEL* (delete) key and the softkey. Press *Exit Assign.* to quit the assign mode.

Note 1: *An empty configuration (all hotkeys de-assigned) will not be stored after Exit Assign. Instead the R&S® CMU restores the default hotkey assignment of the current function group.*

Note 2: *A user-defined assignment is retained even after a Reset of all function groups (Reset key, see p. 4.3).*

Remote control

The R&S® CMU uses extended addressing: The instrument itself is identified by the primary GPIB address. Moreover, a secondary address must be assigned to any combination of a function group and a signalling mode. This is done with the command

```
SYSTEM:REMOte:ADDRes:SECOndary <Address>, <FGrp> | NONE
```

Primary and secondary address handling is described in the remote control Chapters (in particular, refer to chapter 5 and the program examples in chapter 7).

| |
|------------------|
| Hotkeys Set 1 |
|------------------|

The *Hotkeys Set 1* hotkey selects the softkey set 1 for display. The hotkey is active in normal mode and in assign mode; see description of previous hotkey.

The two hotkeys *Hotkeys Set 2* and *Hotkeys Set 3* are analogous to *Hotkeys Set 1*.

| |
|--------------------|
| Audio Multitone |
|--------------------|

The labeling of each softkey on the right side of the menu contains the function group, an icon indicating the test mode, and the measurement assigned to the softkey. The function of the softkeys is as follows:

- In normal mode, pressing a softkey calls up the corresponding measurement.
- In assign mode, pressing a softkey assigns this softkey to the measurement selected in the *Selection* table. Pressing the *DEL* (delete) key and then the softkey cancels the current assignment.

Popup Menu Setup

The popup menu *Setup* contains several tabs used to adapt the R&S® CMU to user requirements. The menus are opened by pressing the *Setup* key. It is possible to change between the tabs by pressing the associated hotkeys.

Printer Settings (Setup – Print)

The *Setup – Print* menu controls the output of data from the R&S® CMU to a printer or a storage medium. The following configurations are provided:

- Printer type and port selection (*Printer*)
- Page settings for the selected printer (*Page Settings*)
- A header for the printed page (*Header*)
- Default file name and directory (*Filename Default*)

Some of the *Setup – Print* configurations serve as default settings and can be modified in the *Print* popup menu before the print process is started (see p. 4.5).

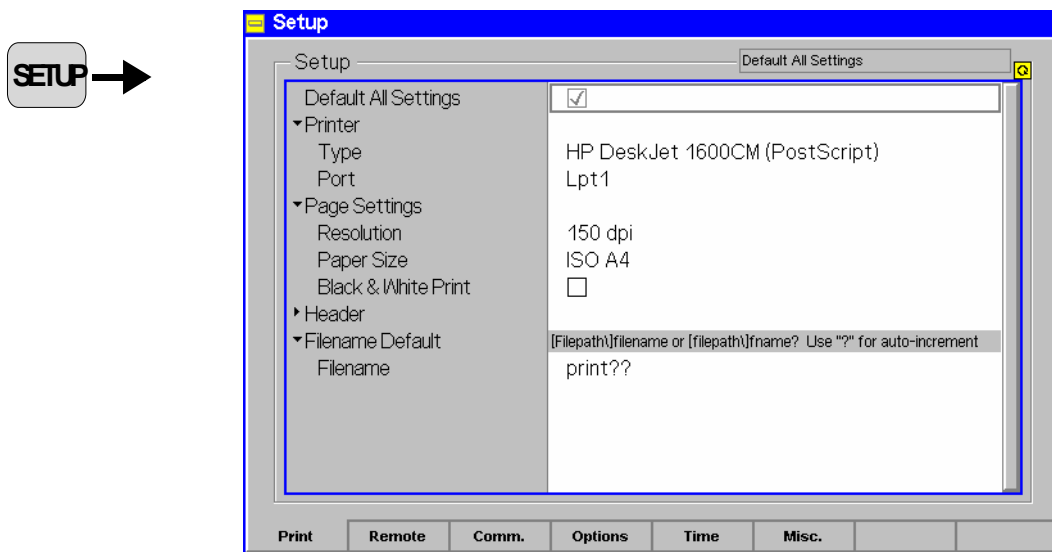

Fig. 4-6 Printer configuration menu (Setup – Print)

Default Settings The *Default All Settings* switch assigns default values to all settings in the *Print* tab (the default values are quoted in the command description in Chapter 6 of this manual).

Printer The *Printer* table section selects a printer type and the printer port. The connection of a printer is described in Chapter 1.

Page Settings The *Page Settings* section activates the input of the page settings for the selected printer.

| | |
|--------------------------------|---|
| <i>Resolution</i> | Fixed 150 dpi printer resolution |
| <i>Paper Size</i> | Selection of ISO A4 or US LETTER paper |
| <i>Black & White print</i> | Color (checkbox off) or black & white printer |

Header The *Header* section defines and activates header for the printed page.

Print header Print the header defined in the *Header Text* input field when a page is printed. An additional comment for every single page can be defined in the *Print* popup menu (see p. 4.5).

Header Text Input field for a header with a maximum length of two lines.

Print Date & Time Inclusion of the current date and time in the header, provided that a header is to be printed.

Filename Default The *Filename Default* section defines a default file name and directory for an output that is written to an internal or external storage medium.

 It is possible to specify a path separated from the filename by a backslash "\" in order to create a directory structure on the storage medium. This path is relative to directory Internal\userdata\print of the R&S® CMU hard disk (*Internal* storage) or the root directory of the *External* storage medium.

Auto-increment function A question mark within the file name is replaced by current numbers that are automatically incremented, starting with zero. The file name *PRINT??* means that the first file stored will be *PRINT00*, the next one will be *PRINT01* etc. To create more than 100 different print files, another name or destination must be specified.

Note: *A third question mark in the file name extends the auto-increment function so that up to 999 print files can be stored. Keep in mind the capacity of the internal hard disk when using this feature.*

Remote control

—

Remote-control Settings (Setup – Remote)

The remote-control menu (*Setup Remote*) defines the remote-control parameters of the R&S® CMU:

- Selection of the interface (*SCPI-Connection*), Setting of the IEC-bus address of the R&S® CMU (*Primary Address*),
- Selection of the desired function group (*Second. Address*).

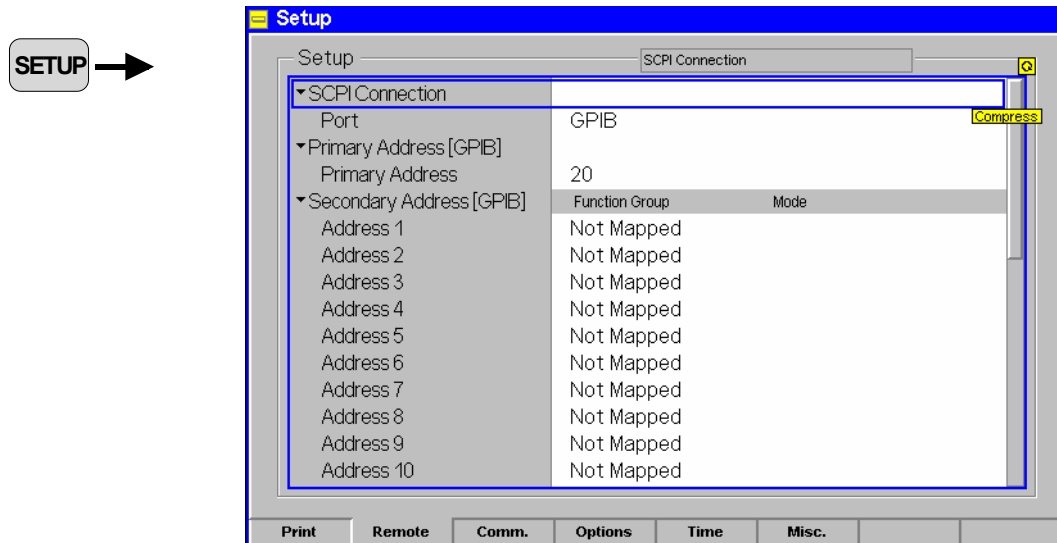

Fig. 4-7 IEC-bus menu

SCPI Connect

The *SCPI Connection* section determines the remote-control interface of the R&S® CMU.

The following interface settings are available:

GPIB + COM1 Auto-detection of the interface, the instruments accepts commands from either the GPIB or COM 1 interface

GPIB IEEE-bus interface according to IEEE 488

COM 1 Serial (RS-232-C) interface COM 1

COM 2 Serial (RS-232-C) interface COM 2

For the characteristics of the interfaces see Chapter 1 and Chapter 8, "Hardware Interfaces".

Primary Address [GPIB]

The *Primary Address* section sets the IEC-bus address of the R&S® CMU. The default setting is 20; addresses 0 to 30 can be assigned.

The IEEE-bus address is addressed in the remote-control commands in the form of the associated primary address, see Chapter 5, *Switchover to Remote Control*, and Chapter 7, *Program Examples*.

Remote control

```
SYSTem:COMMunicate:GPIB[:SELF]:ADDRes 0 to 30
```

```
SYSTem:REMote:ADDRes:PRIMary 0 to 30
```

Secondary Address [GPIB]

The *Secondary Address* section assigns secondary addresses to up to 29 function group and test mode combinations (secondary address 0 is always mapped to the base system; no re-mapping is possible). The available function groups (e.g. *RF Non Signalling*, *Bluetooth Signalling* etc.) can be displayed and selected with the roll-key after an *Address n* field is activated.

The network and the test (signalling) mode are addressed in the remote-control commands in the form of the associated *secondary address*, see Chapter 5, *Setting the Device Addresses*, and Chapter 7, *Program Examples*.

Remote control

SYSTem:REMOte:ADDRess:SECOndary 1 to 29,<FgrpName> | NONE

Local/Remote Mode: Disconnect on Loc ➔ Rem

Defines the behavior of the R&S® CMU in a local to remote transition. The command is valid for all function groups and test modes, however, its effect depends on the test mode (*Signalling* or *Non Signalling* tests, see e.g. GSMxxx-MS manual):

Disconnection on (box checked)

In *Signalling* mode, the connection or call is dropped and the R&S® CMU returns to its default signalling state (e.g. *SOFF* in the *GSMxxx-MS* function groups). In *Non Signalling* mode, all generators are switched off.

Disconnection off In *Signalling* mode, all signalling states are maintained. This makes it possible to switch the instrument to remote control without dropping a call or connection. In *Non Signalling* mode, the current operating state of all generators is maintained.

Remote control

SYSTem:GTRMode:COMPAtible ON | OFF

Local/Remote Mode: Task Priority Management

Determines the behavior of the R&S® CMU if conflicting measurements or generators are run in parallel; see section *Task Priority Management* in Chapter 5.

Task Priority Management

On (box checked) All measurements and generators are releasable: A new measurement/generator has priority over a running measurement/generator.

Off All measurements and generators are persistent: A running measurement/generator has priority over a new measurement/generator.

The *Task Priority Management* setting is not changed after a reset.

Remote control

SYSTem:REMOte:TPManagement ON | OFF

Local/Remote Mode: Switches the remote debug mode on or off. A debug icon indicates that the debug mode is on.

Remote Debug Mode



In remote debug mode, the MMI can be used to visualize, monitor, or check the results of measurements controlled via the remote interface. To make this possible, the behavior of the instrument with respect to measurement and generator control, measurement statistics, and signalling is changed; see section [Remote Debug Mode](#) on p. 4.14.

When the remote debug mode is enabled or disabled, the current measurement is reset and the instrument settings are adjusted according to [Table 4-1](#) on p. 4.14. The remote debug mode has no impact on the measurement performance of the instrument. It is not changed after a reset but disabled when the R&S CMU is restarted.

Remote control

SYSTem:REMOte:RDMoDe ON | OFF

Report – Display If *Report Display* is enabled (box checked), the input and output strings of the remote-control interface are displayed on the *Remote* screen. The remote display consists of three columns:

<Input/output> Colored symbols for input (→) to the R&S® CMU, output (←) or error messages (E).

Fct. Grp. Name of the addressed function group; see description of command `SYSTem:REMOte:ADDReSS:SECOndary` in Chapter 6.

Command Input command string, response/output string of the R&S® CMU or error message.

This parameter is also available as a hotkey in the remote screen; see chapter 5.

Remote control

TRACe:REMOte:MODE:DISPLAy ON | OFF

Report – File *Report File* can be activated (box checked) to write the input and output strings of the remote-control interface to a file named *Remote.trc* in the root directory of the internal hard disk (*INTERNAL* directory in the *Data* menu or directory *C:\temp*). The two parameters *Report Display* and *Report File* may be enabled (checked) at the same time.

This parameter is also available as a hotkey in the remote screen; see Chapter 5.

Remote control

TRACe:REMOte:MODE:FILE ON | OFF

Remote Debug Mode

The remote debug mode is activated in the *Remote* tab of the *Setup* menu; see above. In this mode, the MMI can be used to visualize, monitor, or check the results of measurements controlled via the remote interface. To make this possible, the properties of the generators, measurements, and signalling are changed as follows:

Table 4-1 Differences between manual and remote debug mode

| Parameter | Manual control | Remote debug mode |
|---|--|---|
| Measurements | Started automatically when the menu is opened. Aborted on leaving the menu in order to free the resources. Only measurements in a common menu can be running at the same time. | Measurement state as defined in the remote control script; it is not changed on switching from remote to local and vice versa. Non-conflicting measurements can be running at the same time (see also section <i>Task Priority Management</i> in Chapter 5). |
| Measurement statistics: Repetition Stop Condition | Default settings: Continuous (results updated continuously) None (no stop on error) | Default settings: Single shot (results acquired once) Stop on error |
| Generators | Generators required for a measurement are automatically started when the measurement menu is opened. They are aborted on leaving the menu in order to free the resources. Only generators in a common menu can be running at the same time. | Generator state as defined in the remote control script; it is not changed on switching from remote to local and vice versa. Non-conflicting generators can be running at the same time (see also section <i>Task Priority Management</i> in Chapter 5). |
| Signalling (for network tests) | <i>Connection Control</i> menu opened automatically when a <i>Signalling</i> function group is accessed. <i>BS Signal</i> (for mobile / UE tests) switched on. | No <i>Connection Control</i> menu opened. <i>BS Signal</i> must be switched on explicitly. |

The following **example** illustrates the properties of the remote debug mode after a remote to local transition (the opposite local to remote transition is analogous).

| | |
|---|--|
| RF: CONF:SPEC:CONT:REP CONT, NONE, NONE | Configure the spectrum measurement to run in continuous mode |
| RF: INIT:SPEC | Start the spectrum measurement |
| RF: INIT:POW | Start a power vs. time measurement |
| GOTO LOCAL | Switch over to local control |

| Result: Remote debug mode off | Result: Remote debug mode on |
|---|--|
| Active menu: <i>Power vs. Time</i> The measurement runs in continuous mode (results are updated continuously; the results acquired in the first single shot are lost). The <i>Spectrum</i> measurement is switched off. | Active menu: <i>Power vs. Time</i> The measurement is in the <i>HLT</i> state (the results acquired in the first single shot are displayed). The <i>Spectrum</i> measurement runs in the background. |

Serial Interfaces (Setup – Comm.)

The interface menu (*Setup Comm.*) defines the transmission parameters of the serial outputs COM 1 and COM 2.

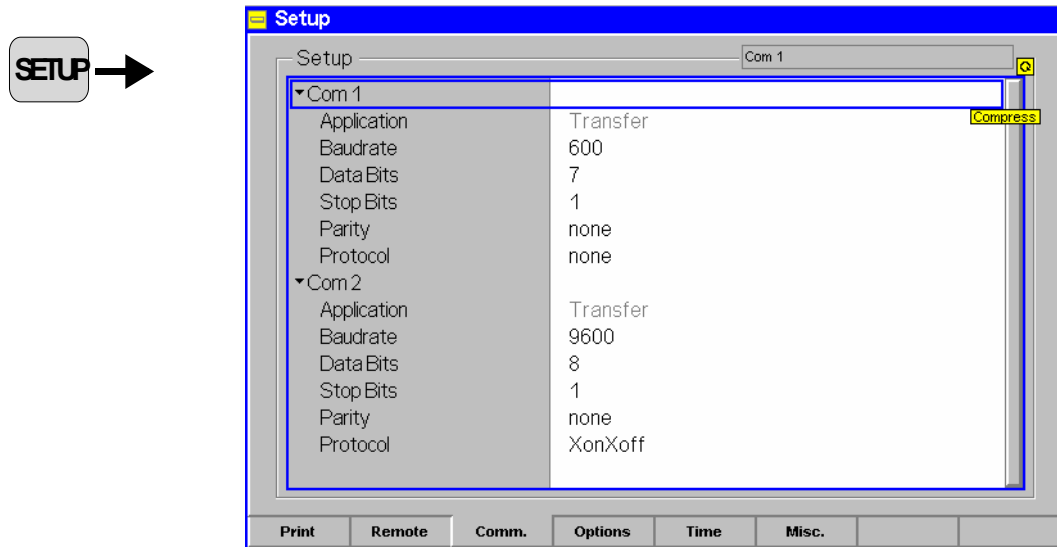

Fig. 4-8 Interface menu

COM 1

The COM 1 section defines the transmission parameters for the serial interface COM 1.

If required, the transmission parameters must be set such as to comply with the parameters of the addressed device (PC etc.). The interface characteristics are explained in detail in Chapter 8, *Hardware Interfaces*. The individual parameters are presented in [Table 4-2](#) below.

The *Application* field indicates whether the serial port is used as a printer connector (*Printer*, if COM 1 was selected as printer port in the *Print* tab; see p. 4.9) or for data transfer to the controller (*Transfer*, default setting). This parameter can not be changed in the *Comm.* tab.

Remote control

```
SYSTEM:COMMunicate:SERiall:APPLication
SYSTEM:COMMunicate:SERiall:TRANsmitt:PACE... etc.
```

Table 4-2 Transmission parameters of the serial interfaces

| Parameter | Meaning | Value range |
|-------------|------------------------|--|
| Application | Addressed device | Transfer Printer (fixed setting) |
| Baud Rate | Data transmission rate | 110 300 600 1200 2400 4800 9600 19200 38400 57600 115200 |
| Data Bits | Number of data bits | 7 8 |
| Stop Bits | Number of stop bits | 1 2 |
| Parity | Number of parity bits | none odd even |
| Protocol | Transmission protocol | none XonXoff CtsRts |

Hardware and Software Options (Setup – Options)

The option menu (*Setup Options*) provides information on the type of instrument and the installed options, equipment and firmware versions (*Software Options, Hardware Options, Hardware Equipment, Firmware Versions*). New software options purchased can be enabled in this menu using a code number.



New software options are most conveniently installed using the Remote Service Tool or VersionManager described in chapter 1.

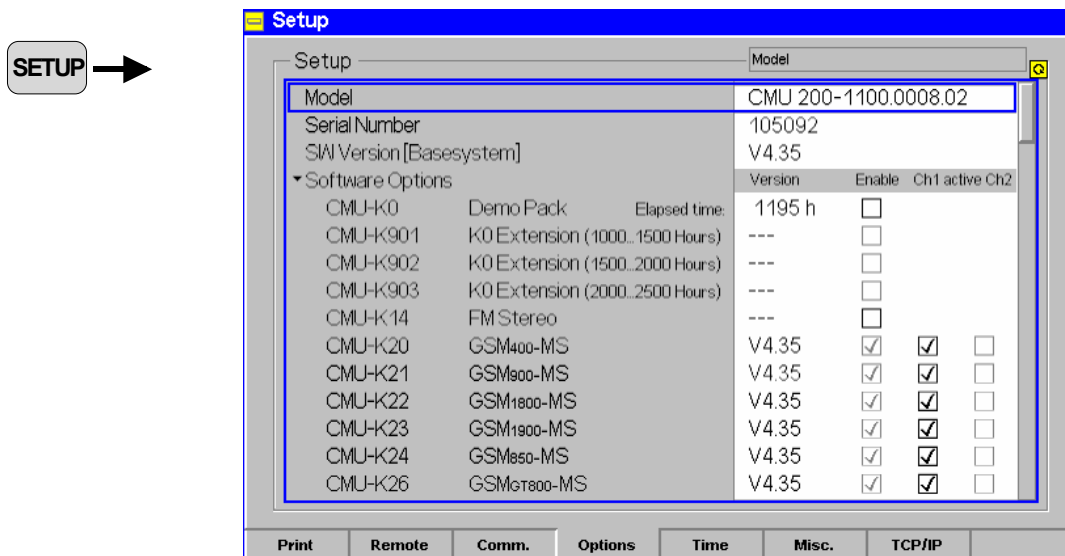

Fig. 4-9 Options menu

Info section: The three lines above the *Software Options* section contain the following information on the instrument.

Model Instrument model
Serial No. Serial number of the instrument
SW Version Installed base system firmware with date of release

Remote control

SYSTem:OPTions:INFO?

additional information about the installed firmware options can be queried via SYSTem:OPTions:INFO:CURRent? in all function groups and test modes.

Software Options

The *Software Options* section contains a list of all software options for the R&S® CMU. The check boxes behind each software option determine the system configuration:

Enable Enable (box checked) or disable software option. Options purchased with a new unit are already enabled. Software options purchased later must be explicitly enabled with a key code to be functional; see below.

Ch1 active Ch2 Activate (box checked) or deactivate software option on the next reboot. After deactivating an option by unchecking one of the boxes, the CMU displays the following message:

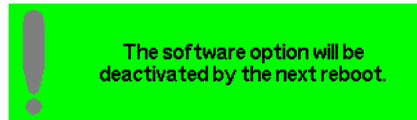

Deactivating software options that are temporarily not needed improves the system performance, especially during the start-up process when all active firmware options must be loaded. An enabled but deactivated option can be re-activated any time without any key code or other additional input.

Note: Some options, e.g. options CMU-K39 to CMU-K43, are supplementary options extending the GSM-BTS and GSM-MS options. The supplementary options must be enabled with a key code but can not be deactivated. No Ch1 active Ch2 boxes are provided.

Enabled options are active by default. Disabled options are inactive and can not be activated.

Remote control

```
SYSTem:OPTions?
*OPT?
```

Enabling software options

Software options can be enabled or disabled in the *Enable* check boxes of the *Software Options* table. As all software options are already included in the firmware, enabling does not require any re-installation, but only a key code which is supplied with the option.

- Select the respective line in the list of software options (in the example of Fig. 4-9 the line *CMU-K20 GSM400-MS*).
- Press the *Enter* key.

The popup window *Option Enable* appears on the screen:

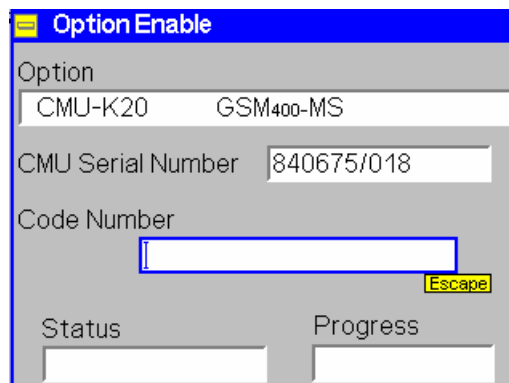

The *Option Enable* window contains the following fields:

Option Short designation and name of option
CMU Serial Number Serial number of the CMU basic instrument

| | |
|--------------------|--|
| <i>Code Number</i> | Code number of the option to be installed |
| <i>Status</i> | Indication of the next operating step to perform |
| <i>Progress</i> | Progress of the enabling procedure |

Of the five fields, only the *Code Number* can be edited. The name of the option being enabled and the serial number of the CMU are automatically entered into the corresponding fields.

- Enter the code number of the option in the input field *Code Number*.
- Confirm the entry using *Enter*.

The option is automatically enabled.

Demo Pack option and extensions

The *Demo Pack* option R&S CMU-K0 enables the instrument as a demo unit for the first 1000 hours of its operation. The demo unit has all other installed software options enabled.

Elapsed Time shows the total number of operating hours of the instrument. This value is updated every time the instrument is re-started. After 1000 hours of operation have elapsed, it is no longer possible to enable the demo pack option (the *Enable* check box is gray and cleared).

Each of the options R&S CMU-K901, R&S CMU-K902, R&S CMU-K903 extends the period of time where the R&S CMU operates as a demo unit by another 500 hours. The options must be enabled in ascending order. In the example of Fig. 4-9 above, the *Elapsed Time* is 1195 hours. After enabling option R&S CMU-K0 and then R&S CMU-K901, the instrument will operate as a demo unit for another 1500 h – 1195 h 305 h.

Remote control

–

Hardware Options / Hardware Equipment / Firmware Versions

The *Hardware Options* section lists all hardware options for the current CMU model (CMU200 or CMU300). Additional hardware accessories are listed in the *Hardware Equipment* section. The table shows the product index or *not installed*, if the CMU is not equipped with the hardware option or equipment.

Note: *An comprehensive list of the hardware equipment of the instrument is provided in the Info menu; see p. 4.25.*

The FW version for RXTX Board 1 (uP1) and RXTX Board 2 (uP2) is displayed in the *Firmware Versions* section. This information is mainly intended for service purposes.

Further information on the options can be found in the data sheet.

Note on Front Module Controller

The version of the Front Module controller has an impact on the shut down process of the instrument; see chapter 1, section Switching off the Instrument. When operating instruments equipped with an FMR 6 in remote control mode, it is recommended to disable the nonvolatile RAM, see command `SYSTem:NONVolatile:DISable` in Chapter 6.

Instruments equipped with an FMR 7 are delivered with a compact flash (CF) card reader; see description in chapter 1..

Remote control
 SYSTem:OPTions?
 *OPT?

Time Settings (Setup – Time)

The *Setup Time* tab shows and permits to change the following settings:

- The (current) time zone, time and time convention (*Time*)
- The (current) date (*Date*)

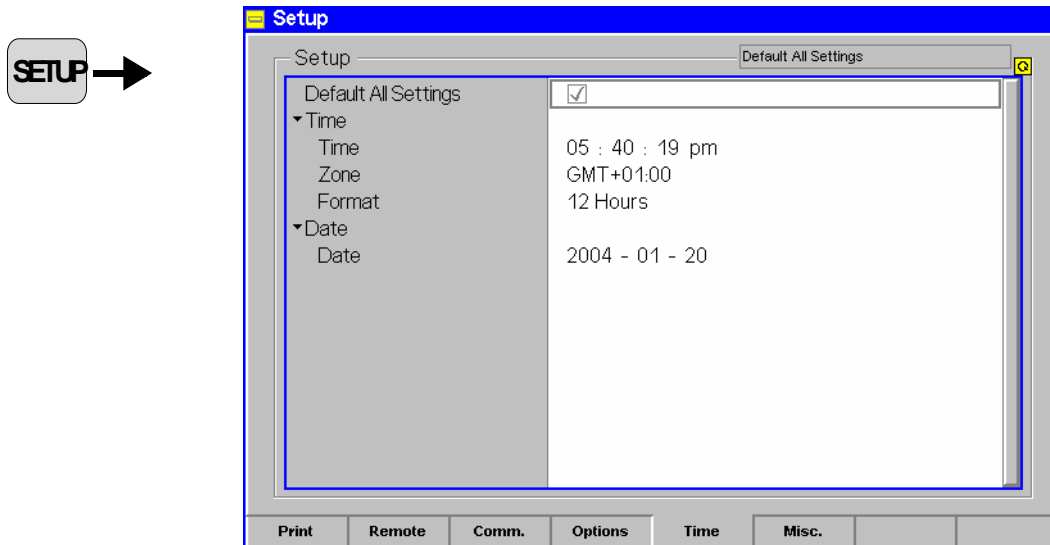

Fig. 4-10 Time menu

Default Settings The *Default All Settings* switch assigns default values to all settings in the *Time* tab (the default values are quoted in the command description in Chapter 6 of this manual).

Remote Control

–

Time The *Time* table section sets the current time and its display format:

hh:mm:ss. Time in the format hours:minutes:seconds

Zone Selection of the time zone, Middle European time (Greenwich mean time (GMT) + 1 h) is set by default

Format 12 Hours: 12:00:00 am ... 11:59:59 am
12:00:00 pm ... 11:59:59 pm
24 Hours 0:00:00 ... 23:59:59

Remote control

SYSTem:TIME:TIME

SYSTem:TIME:TZONE

Date The *Date* section defines the current date in the format yyyy-mm-dd (year-month-day).

Remote control

SYSTem:DATE

Acoustic Signal and Keyboard (Setup – Misc.)

The *Setup Misc.* menu activates the acoustic signal (*key beep*), configures the display, and selects the keyboard assignment (*Keyboard*).

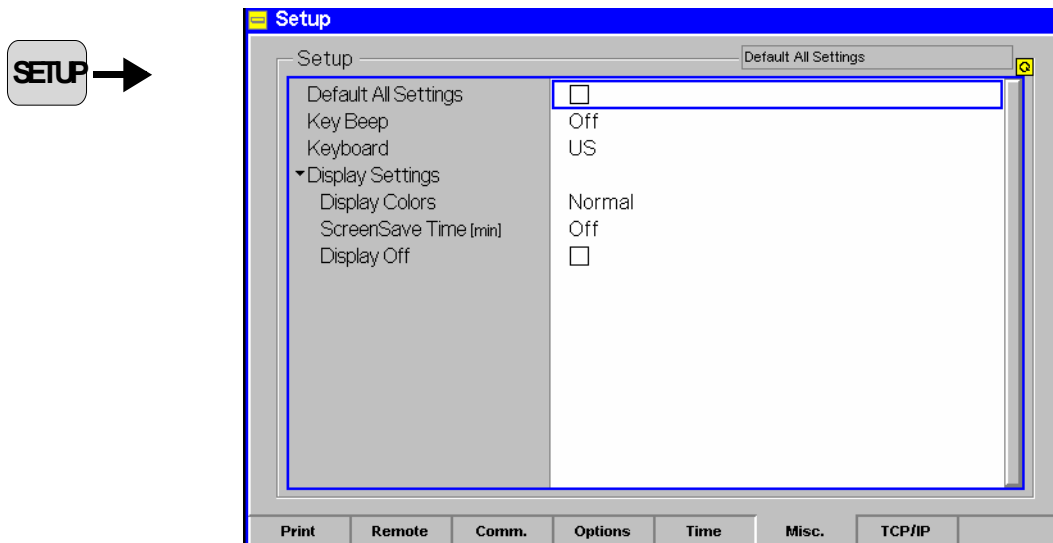

Fig. 4-11 Setup – Misc. menu

Key Beep

Key Beep switches the acoustic signal of the R&S® CMU on or off. If the key beep is *On* the R&S® CMU sends a discreet acoustic signal whenever a key is pressed. The default setting is *Off*.

Remote control
 SYSTem:MISC:KBEEP

Keyboard

Keyboard selects the keyboard assignment (*German* or *US* keyboard).

Remote control
 SYSTem:MISC:KEYBOARD

Display Settings

The *Display Settings* configures the R&S® CMU LC display:

Display Color Selects the brightness of the display. In the *High Contrast* setting, the display is darker; the contrasts are enhanced.

Screen Save Time Defines a time in minutes after which the display will turn dark if no front panel key is pressed. Remote control commands have no influence on the screen saver.

Display Off Turns the display off. The display is turned on again by pressing any front panel key.

Remote control
 DISPlay[:WINDOW] ON I OFF

TCP/IP Address Settings (TCP/IP)

The *Setup TCP/IP* menu configures the R&S CMU with the IP address information necessary for communicating with other hosts and applications through an IP network:

- The *CMU-B21* section provides the IP address information for the *Universal Signalling Unit CMU-B21 V14*, to be used for GSM and WCDMA UE data application tests. For detailed information refer to the operating manuals for *WCDMA UE Tests (R&S CMU-K61, ..., K69)*, for the *WCDMA Message Analyzer and Recorder (R&S CMU-Z46)*, and for *(E)GPRS Application Testing (R&S CMU-K92)*.
- The *CMU-B83* section provides the IP address information for the *Universal Signalling Unit CMU-B83*, to be used for CDMA2000 data application tests. For detailed information refer to the operating manuals for *CDMA200 Mobile Tests (R&S CMU-K83, ..., K87)* and for the *Message Monitor for CDMA2000 Signalling Unit (R&S CMU-B87)*.

Attention! If you choose static TCP/IP addressing, contact your network administrator to obtain a valid IP address. Connection errors can affect the entire network.



The TCP/IP information is not changed after a reset (*RST) of the instrument. The default values (factory settings) can be restored using the Default Settings switches.

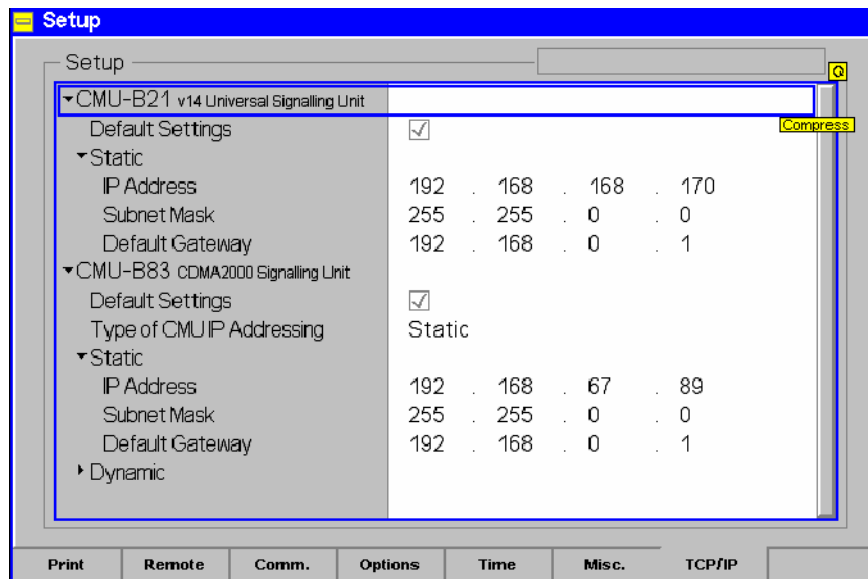

Fig. 4-12 Setup – TCP/IP menu

To avoid a mix up of the two address blocks, a popup menu is opened when one of the addresses is changed. The popup menu contains the (static) addresses for a single signalling unit; they are closed by pressing the *SETUP* key again.

The following static address information is assigned to the CMU-B21 signalling unit:

CMU-B21 – Default Settings Restores the default IP addresses for R&S CMU-B21 shown in the figure above. The values are also quoted in the command description in Chapter 6 of this manual. A reset does not affect the IP addresses.

Remote Control `SYSTem:TCPIP:PRIMary:DEFault ON | OFF`

CMU-B21 – Static IP addresses for the R&S CMU, to be used for GSM and WCDMA UE data application tests.

IP Address IP address of the CMU
Subnet Mask Subnet Mask address of the CMU
Default Gateway Address used to configure a default route in the CMU

Remote Control `SYSTem:TCPIP:PRIMary:STATic:IPAdDress <IP1>, <IP2>, <IP3>, <IP4>`
`SYSTem:TCPIP:PRIMary:STATic:SMASk <SM1>, <SM2>, <SM3>, <SM4>`
`SYSTem:TCPIP:PRIMary:STATic:DGATeway <GW1>, <GW2>, <GW3>, <GW4>`

The following address information is assigned to the CMU-B83 signalling unit:

CMU-B83 – Default Settings Restores the default IP addresses for R&S CMU-B83 shown in the figure above. The values are also quoted in the command description in Chapter 6 of this manual. A reset does not affect the IP addresses.

Remote control
`SYSTem:TCPIP:SECondary:DEFault ON | OFF`

CMU-B83 – Type of CMU IP Addressing Depending on the network capacities and the user preferences, the TCP/IP address information for the R&S CMU-B83 can be configured in two different ways:

Static Manual setting of the addresses in the *Static* TCP/IP address subsection. This option must be selected if the network does not support dynamic TCP/IP configuration using the Dynamic Host Configuration Protocol (DHCP).

Dynamic Automatic assignment of all necessary addresses (including the MS PPP IP and BS PPP IP addresses displayed in the *Service Config.* tab of the *Connection Control* menu for the CDMA2000 function groups; see Chapter 8 of the CDMA200 operating manual) using a definite CMU hostname and DHCP (dynamic TCP/IP configuration). See description of the *Dynamic* subsection below.

Dynamic (Retry)? Repeat the dynamic addressing procedure. This message is displayed after a failed attempt to use dynamic addressing. Possible error scenarios are listed in [Table 4-1 below](#).

Remote control
`SYSTem:TCPIP:SECondary:MODE`
`STATic | DYNamic (| PENDING | UDEF)`
`SYSTem:TCPIP:SECondary:FCODE?`

CMU-B83 – Static Sets the IP addresses to be used if *Static* CMU IP addressing is selected:

IP Address IP address of the CMU
Subnet Mask Subnet Mask address of the CMU
Default Gateway Address used to configure a default route in the CMU

Remote Control SYSTEM:TCPIP:SECondary:STAtic:IPADdress <IP1>, <IP2>, <IP3>, <IP4>
 SYSTEM:TCPIP:SECondary:STAtic:SMASK <SM1>, <SM2>, <SM3>, <SM4>
 SYSTEM:TCPIP:SECondary:STAtic:DGATeway <GW1>, <GW2>, <GW3>, <GW4>

CMU-B83 – Dynamic Sets the CMU hostname and displays the IP addresses obtained from the network if *Dynamic* CMU IP addressing is selected. To establish a dynamic IP connection proceed as follows:

1. In the Dynamic subsection, enter the CMU Hostname you wish to assign to the CMU.
2. Select dynamic Type of CMU IP Addressing.

During the IP address acquisition phase, the CMU hostname is registered with the DHCP server and the CMU displays the message *DHCP Procedure Pending*. This operation may take several seconds to complete depending on network traffic, DHCP server congestion, etc. When the DHCP procedure completes, the acquired addresses are be displayed in the *Dynamic* TCP/IP address subsection. If dynamic TCP/IP configuration fails, the R&S CMU displays one of the failure messages listed in Table 4-1 below and the Ethernet interface is disabled.

Note: *When the DHCP server on the network is running Windows Server, the DNS is not properly notified of the CMU hostname. In order to identify the CMU by its hostname, it will be necessary to add the hostname, along with the IP address obtained from DHCP and displayed on the CMU, to the DNS table. This must be done whenever the CMU is re-booted and thus obtains a new address via DHCP. If the CMU is not added to the DNS table, the instrument must be identified only by its IP address.*

Remote Control SYSTEM:TCPIP:SECondary:DYNamic:HNAME
 SYSTEM:TCPIP:SECondary:DYNamic:DNS?
 SYSTEM:TCPIP:SECondary:DYNamic:IPADdress?
 SYSTEM:TCPIP:SECondary:DYNamic:SMASK?
 SYSTEM:TCPIP:SECondary:DYNamic:DGATeway?

DHCP Failure The R&S CMU contacts the DHCP server during the following scenarios:

- At R&S CMU initialization (if Type of CMU IP Addressing is set to Dynamic).
- At run-time when the user changes the *Type of CMU IP Addressing* from *Static* to *Dynamic*
- At run-time when the lease has expired. The DHCP client is required to renew its lease with the DHCP server when the lease duration has expired.

The DHCP procedure may fail for a number of reasons. Possible failure scenarios and error messages in the *Type of CMU IP Addressing* field are listed in [Table 4-1 below](#). In case of a failure the *Dynamic* parameter field and a yellow notice box show *DHPC Failure – External Ethernet IP connection is now disabled*.

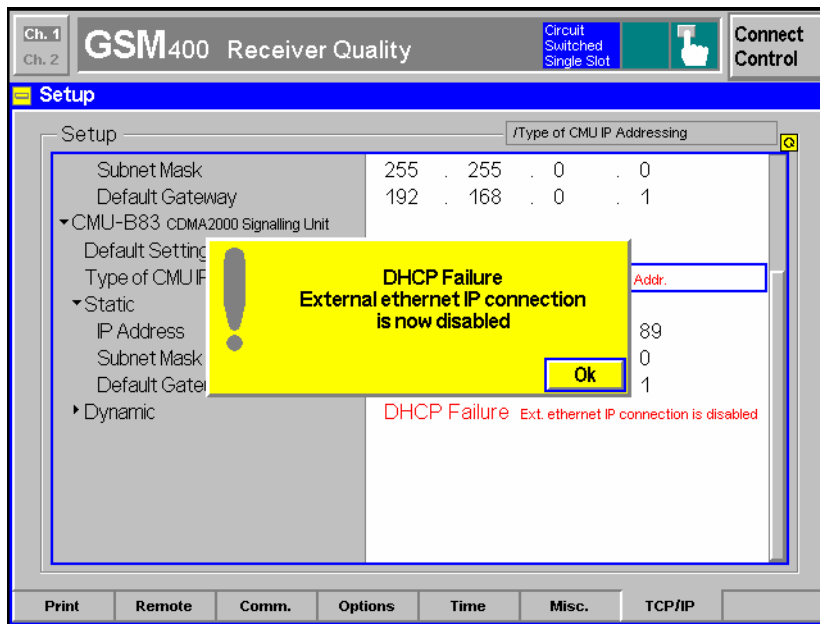

Whenever a DHCP failure condition is detected, the R&S CMU takes the following actions:

- The CMU200 Ethernet interface is disabled.
- Bit no. 14 of the `STATUS:OPERation` register for the R&S CMU base system and bit no. 1 of the extended `STATUS:OPERation` register for the CDMA2000 function groups is set (see Chapter 5 and CDMA2000 operating manual).

By disabling the Ethernet interface, the CMU200 will not be able to communicate with any remote host.

- Dynamic CMU *IP Address* is set to “169.254.X.X” (where X.X is derived from the serial number of the CMU200)
- Dynamic CMU *Subnet Mask* is set to “255.255.0.0”.
- Dynamic CMU *Default Gateway* address is removed.
- Dynamic MS and BS PPP IP Addresses (see Chapter 8 of the CDMA2000 operating manual) are set to the static MS and BS PPP IP Address values.

By maintaining these PPP IP Addresses, the CMU200 will still be able to establish SO33 data calls to a CDMA2000 mobile station. Only the internal FTP server can be used to transfer data to/from the mobile since no outside communication is possible.

Remote Control `SYSTEM:TCPip:SECondary:FCODE?`

Table 4-1 DHCP Failure Scenarios, error messages and error codes

| Message in <i>Type of CMU IP Addressing</i> | Error code <code>CONF:TCP:SEC:FCOD?</code> | Failure reason | Possible cause |
|---|---|--|--|
| Dyn. Event Failed | -1 | The DHCP Server failed to respond or rejected the DHCP request. | <ul style="list-style-type: none"> • CMU200 ethernet cable not properly connected to LAN • DHCP server unavailable |
| No Target IP Allocated | -2 | The DHCP Server failed to allocate the Target (CMU200) IP Address. | <ul style="list-style-type: none"> • CMU200 ethernet cable not properly connected to LAN • DHCP server unavailable |

| Message in Type of CMU IP Addressing | Error code CONF : TCP : SEC : FCOD? | Failure reason | Possible cause |
|--------------------------------------|--|--|--|
| Interface Down | -3 | The CMU200 Ethernet Interface is disabled. | CMU200 ethernet cable not properly connected to LAN |
| No Router IP Allocated | -4 | The DHCP Server failed to allocate the Router/Gateway IP Address. | DHCP server not configured to support TAG 3 (router). See RFC 2132 for more details. |
| Mobile Home IP Addr. | -5 | The DHCP Server failed to allocate the BS and MS PPP IP Addresses. | <ul style="list-style-type: none"> DHCP server not configured to support TAG 68 (mobile IP home agent). See RFC 2132 for more details. DHCP server not configured to return 2 IP Addresses in TAG 68 (mobile IP home agent). See RFC 2132 for more details. |
| Bind Failure | -6 | The CMU200 failed to initialize the DHCP client software. | Internal CMU200 DHCP software initialization problem. |

System Information (Info)

The *Info* popup menu, which is opened by pressing the *INFO* key, displays comprehensive information on the instrument and its components. Part of the information is also displayed in the *Options* tab of the *Setup* menu; see p. 4.16.

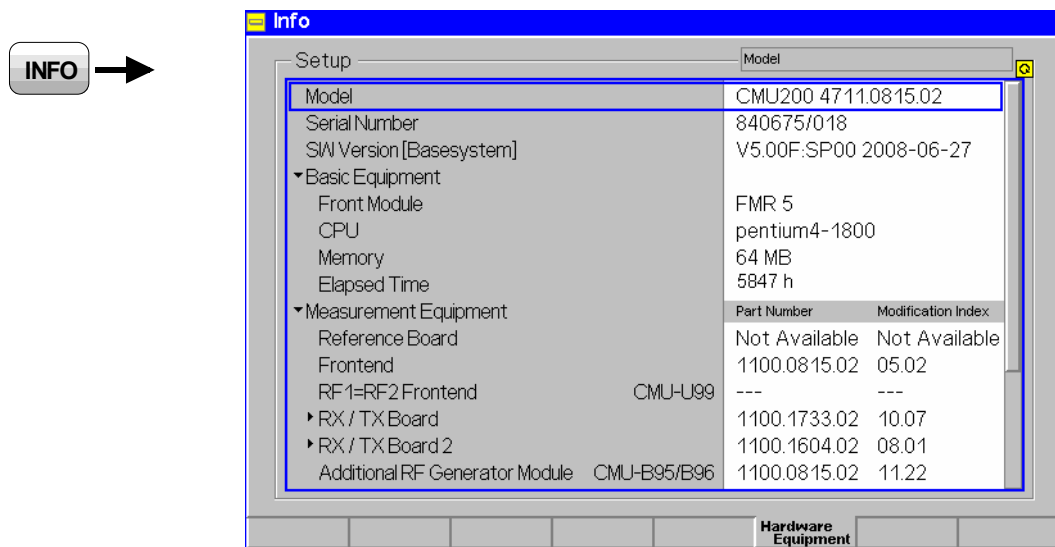

Fig. 4-13 Info – Hardware Equipment

Selftest (Maintenance)

The *Maintenance* popup menu, which is accessible via the *BASE* function group in the *Menu Select* menu, complements the *Info* menu (see p. 4.25 above) in providing service information, selftests and correction procedures that are aimed to improve particular measurements. The selftests are primarily intended for production and service purposes and therefore not needed during normal operation of the instrument. The following description serves as a general overview.

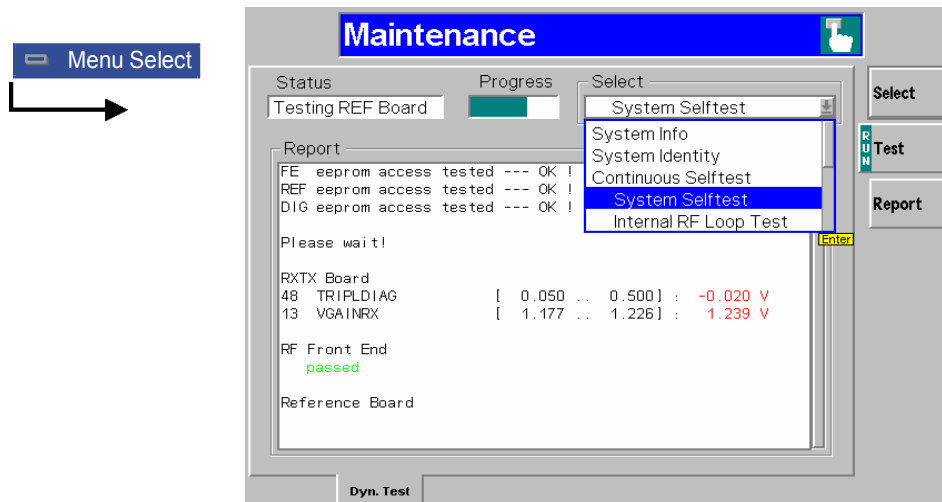

Fig. 4-14 Selftest – Maintenance menu

Select

The *Select* softkey selects the type of selftest or correction procedure to be performed.

Note: *The Select drop-down list always contains all entries listed below. If the selftest is started for a board that is not available in the unit, a message '<Board_Name> board is not available' is displayed.*

System Info Provides information on the system memory and the hardware and software configuration. If *System Info* is selected and the *Test* activated (see below), the R&S® CMU lists all deliverable hardware and software options in the report table and indicates whether they are available on your R&S® CMU.

System Identity Scans all modules and stores the part numbers and production data to file c:\identity.dat. In addition the available software versions are written to the log file C:\INTERNAL\LOG\VERSION.LOG.

| | |
|-----------------------------------|---|
| <i>Continuous Selftest</i> | Continuous combined <i>System Selftest</i> and <i>Internal RF Loop</i> selftest. The continuous selftest is repeated until it is explicitly switched off. |
| <i>System Selftest</i> | Tests all modules one after another and displays a pass/fail message. |
| <i>Internal RF Loop Test</i> | Test of frequencies and levels at RF connector using the R&S® CMU's internal RF generator and analyzer with internal RF coupling. The loop 2 test is for future extensions. |
| <i>1->4/3->2 RF Loop T.</i> | Test of frequencies and levels for the RF path between the connectors RF1 → RF4 IN and RF3 OUT → RF2. For this test, special external N coax cables (included in service kit CMU-Z3) must be used to close the RF path. The loop 2 test is for future extensions. |

The remaining tests are selftests for individual modules, e.g. Linkhandler (all models of Universal Linkhandler and Universal Signalling Unit), Front End, Reference Board, Digital Board, RXTX Board 1, Audio Board, I/Q-IF Board (Option CMU-B17), Aux Tx Board (Option CMU-B95 or CMU-B96, whichever is fitted), CMU-B83 (reloads the firmware for CMU-B83 including CMU-B88 (if available) and reboots the system). Besides, the following correction procedures are available:

| | |
|---------------------------------------|--|
| <i>Audio Board Calib.</i> | Improves the accuracy of Audio measurements (with option CMU-B41; see section <i>Audio Generator and Analyzer</i>). |
| <i>FM Modulation Calib.</i> | Improves the accuracy of measurements on FM-modulated signals (e.g. for <i>Bluetooth</i> (CMU-K53), AMPS (CMU-K29)) and the accuracy of FM modulated RF generator signals (e.g. for <i>RF Measurements</i>). An FM modulation calibration is also required for generating an FM modulated RF signal in function group RF. To this end, it is sufficient to perform the calibration once after installing the RF software; the CMU will store the calibration data. |
| <i>Correction Filter Cal.</i> | Improves the accuracy of WCDMA modulation measurements (only with options CMU-K65/.../K69 (CMU200) or CMU-K75/-K76 (CMU300) and CMU-Z6, see operating instructions for CMU-Z6, stock no. 1150.0199.12). |
| <i>L1CoPro Level Cal.</i> | Improves the level accuracy of the downlink WCDMA generator (option CMU-K66). Both the TX and the RX path are calibrated. The calibration is particularly important if power measurements at fixed target power are performed; it compensates for a systematic offset of approx. 12 dB. |
| <i>IF 3 Selftest</i> | Internal evaluation if the IF3 level, only available for RXTX board versions with TAZ \geq 12.00. |
| <i>Internal Aux Tx Loop Path 1/2</i> | Same as <i>Internal RF Loop Test</i> , but for the (low-level) Aux Tx signal (option R&S CMU-B95 for path 1, option R&S CMU-B96 for path 1 or path 2). The overrange signals of option CMU-B96 are tested separately using the <i>Internal Aux TxW Loop Path 1/2</i> tests. |
| <i>Internal Aux TxW Loop Path 1/2</i> | Same as <i>Internal RF Loop Test</i> , but for the <i>Overrange</i> Aux Tx signal associated with path 1 or path 2 (option CMU-B96). The low-level Aux Tx signals of option CMU-B96 are tested separately using the <i>Internal Aux Tx Loop Path 1/2</i> tests. The <i>Aux TxW</i> tests can not be performed if option CMU-B95 is fitted instead of option CMU-B96. |
| <i>Hardware Data Verification</i> | Performs a plausibility check for the EEPROM data of all installed hardware modules. |
| <i>Settling Time Cal.</i> | Determines the settling times for RX and TX signals that the instrument requires after a change to a frequency band above 1.2 GHz. The obtained value is stored and applied in order to avoid measurement inaccuracies. A settling time calibration is relevant for RXTX board versions with TAZ \leq 10.00 only. |

Note: Notice messages after firmware updates

In most cases firmware updates don't affect the accuracy of the measurements. There are some exceptions where a correction procedure must be executed after the firmware update. The R&S® CMU displays a notice message whenever this happens. The box contains the name of the required correction procedure and appears during startup until the correction has been performed.

Remote control

–

Test

The *Test* softkey controls the selftest of the type selected via the *Select* softkey and displays the results in the *Report* table.

The status of the selftest (*RUN*, *OFF*, *HLT*) is indicated on the left side of the softkey. It can be changed after softkey selection (press once) by means of the *ON/OFF* key.

A short description of the current test appears in the *Status* output field; its progress is shown in the *Progress* bar.

Remote control

–

Report

The *Report* softkey activates the *Report* table, e.g. for scrolling.

Remote control

–

Data Handling (Data)

The *Data* popup menu, which is opened by pressing the *DATA* key, saves and recalls configuration files, handles log files for GSM layer 3 messages and manages the files in the internal memory that can be used for mass storage.

Saving Configurations (Data – Save)

The *Save* tab in the *Data* popup menu stores the current instrument settings to a configuration file. Configuration files have the extension *.SAV and contain the following information:

- All user-defined settings of a particular function group and test mode comprising all measurement settings (defined in the measurement configuration menus) and all general settings (defined in the *Connection Control* menu)
- For *Signalling* test mode, all settings concerning signalling (connection setup etc.)
- For the *Base* system, the current function group, test mode and measurement menu.

The configuration of several function groups and test modes can be written to a common configuration file. The configuration of the current session is automatically stored in the non volatile RAM before a session is terminated and re-activated when the R&S® CMU is started next time; see also Chapter 1, section *R&S® CMU VersionManager*.

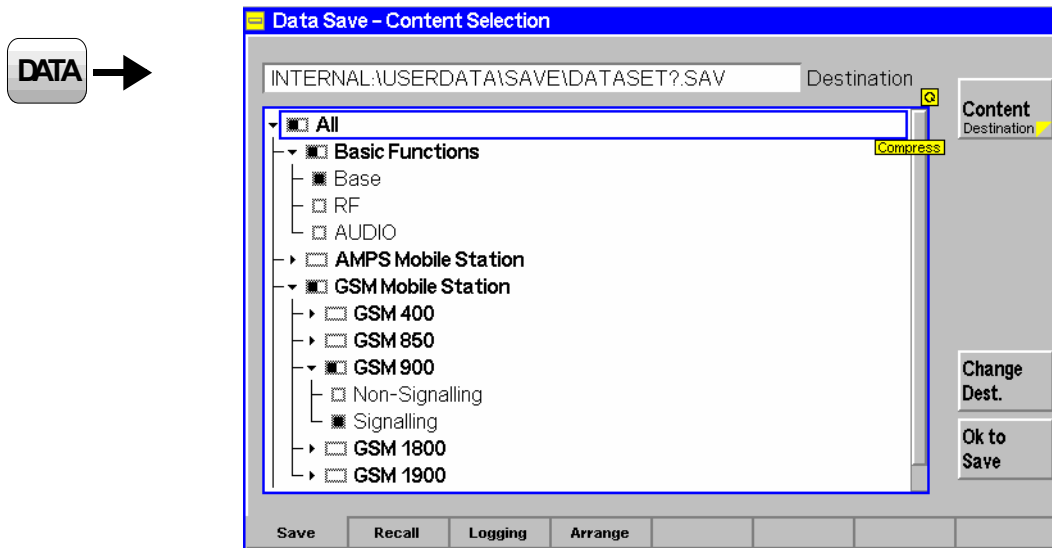

Fig. 4-15 Data – Save menu

Selection of
function groups

All function groups and test modes available on the instrument are arranged in a tree view showing the function groups and test modes to be saved to a configuration file. When the popup is opened, the configuration tree is expanded and the active function group and test mode is selected. The tree view is identical to the tree in the *Reset* menu (see section [Reset of Instrument Settings \(RESET Key\)](#) on p. 4.3).

The *Base* system is part of every software configuration and therefore selected by default irrespective of the current function group and mode. It is possible though to exclude the base system settings from the configuration file by deselecting the *Base* node.

Note: *If the base system is excluded from the configuration, the current function group, test mode and measurement menu are not stored to the configuration file. In this case it can be useful to write this information to the file comment; see Change Dest. softkey below.*

Content
Destination

Content/Destination toggles between the configuration tree (see [Fig. 4-15 above](#)) and a view of the directories available for storing the configuration file (*.SAV). The *Destination* view is analogous to the *Arrange* tab; see section [File Manager \(Data – Arrange\)](#) on p. 4.37.

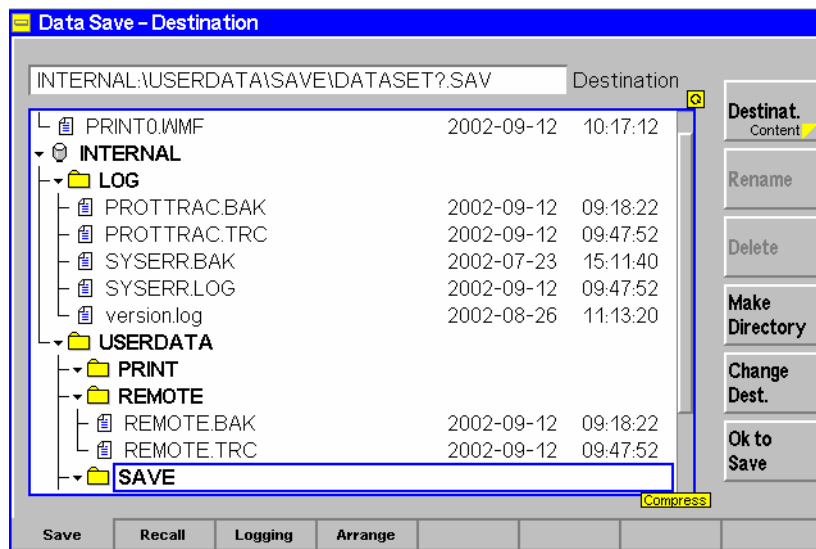

Remote control

–

Change Dest.

The *Change Dest.* softkey opens a dialog to specify the name and path of the created configuration file and enter a *Comment* to be stored with the file. See also [View Info/Rename](#) softkey on p. 4.38.

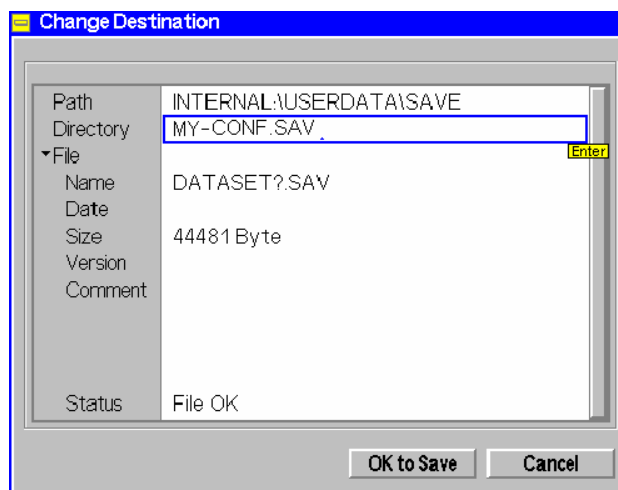

Editing the *Change Destination* dialog is optional: By default, the R&S® CMU stores configuration files to the directory `INTERNAL\USERDATA\SAVE` and uses the file names `DATASET?.SAV` where the question mark is replaced by current numbers that are automatically incremented, starting with zero (auto-increment function). To create more than 100 different configuration files, another name or destination must be specified. The information stored in a configuration file can not be edited.

Note: A third question mark in the file name extends the auto-increment function so that up to 999 configuration files can be stored. Keep in mind the capacity of the internal hard disk when using this feature.

Selecting *OK to Save* closes the dialog window and stores the inputs made. Pressing *Cancel* or *Change Dest.* again without selecting *OK to Rename* closes the dialog box, discarding all inputs made.

Remote control

The path, directory, file name and comment of an existing configuration file can be changed using the `MMEMory` commands; see section [File Manager \(Data – Arrange\)](#) on p. 4.37.



OK to Save saves the current configuration in all function groups and test modes selected in the configuration tree to the configuration file specified via *Change Dest.*

Note: Saving only the configuration of the active function group is faster because no additional software modules must be loaded.

Remote control

```
MMEMory:SAVE:CURRENT <FileName> [, <msus>]
MMEMory:SAVE[:ALL] <FileName> [, <msus>]
```

Loading Saved Configurations (Data – Recall)

The *Recall* tab in the *Data* popup menu recalls and activates a configuration previously stored with the *Save* tab; see section current instrument settings to a configuration file (*.SAV); see section [Saving Configurations \(Data – Save\)](#) on p. 4.29.

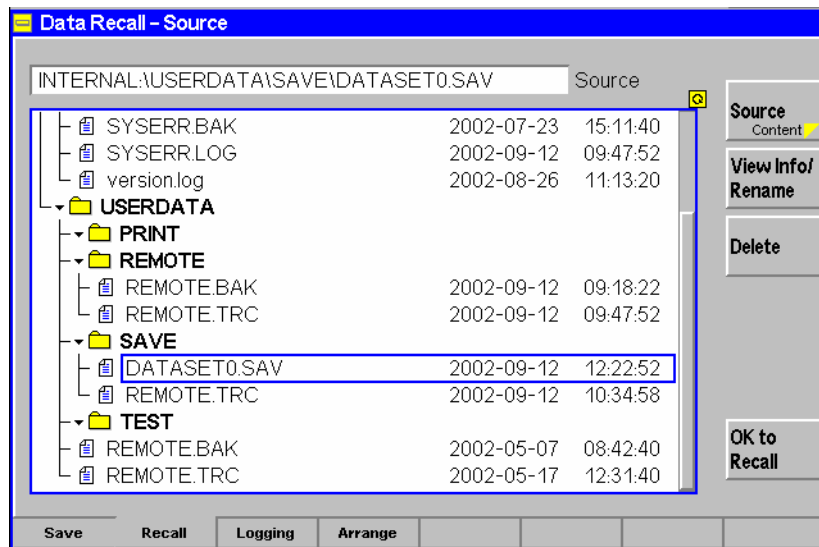

Fig. 4-16 Data – Recall menu

The *View Info/Rename* and *Delete* softkeys are equivalent to the softkeys of the same name in the *Arrange* tab; see section [File Manager \(Data – Arrange\)](#) on p. 4.37.

File selection The stored files can be selected from a tree view in the center of the menu. The tree can be expanded and compressed using the roll-key and the *ON/OFF* key (see Chapter 3, *Expanding menu tables*). By default, configuration files are stored in the directory *INTERNAL\USERDATA\SAVE* and with the file names *DATA??.SAV*, where the question mark is replaced by a current number.

Source
Content

Source/Content toggles between the directory view (see Fig. 4-16 *above*) and the overview of function groups and test modes contained in a configuration file (configuration tree); see *Dir. View/Content* softkey on p. 4.38.

The configuration tree can be used for a partial recall of instrument settings: On recalling a configuration file, only the settings in the function groups and test modes selected in the configuration tree are overwritten. By default all function groups and test modes stored in the configuration file are selected.

Remote control

–

OK to Recall

OK to Recall recalls the selected configuration file and activates the stored settings for the function groups and test modes selected in the configuration tree.

The active function group, test mode and measurement menu is stored with the *Base* system settings when a configuration file is created. As a consequence the behavior of the R&S® CMU after a recall depends on whether or not the *Base* system settings are also recalled:

- After a recall including the base system settings the R&S® CMU enters the function group, test mode and measurement menu stored in the configuration file.
- After a recall excluding the base system (or a recall of a configuration file without base system information) the R&S® CMU returns to its current function group.

Note: *Recalling only a configuration of the active function group is faster because no additional software modules must be loaded.*

Before recalling and activating a configuration file, the instrument checks whether the settings are compatible with its current hardware configuration and software versions. If an incompatibility is detected, the configuration file is not recalled and an error message is generated. Configuration files are upward compatible and can be re-used in later firmware versions.

Remote control

MMEMory:RECall:CURRent <FileName> [,<msus>]

MMEMory:RECall[:ALL] <FileName> [,<msus>]

Layer 3 Message Log (Data – Logging)

The *Logging* tab in the *Data* popup menu activates recording of the layer 3 messages transferred during a GSM-MS Signalling session and selects a destination file for this information.

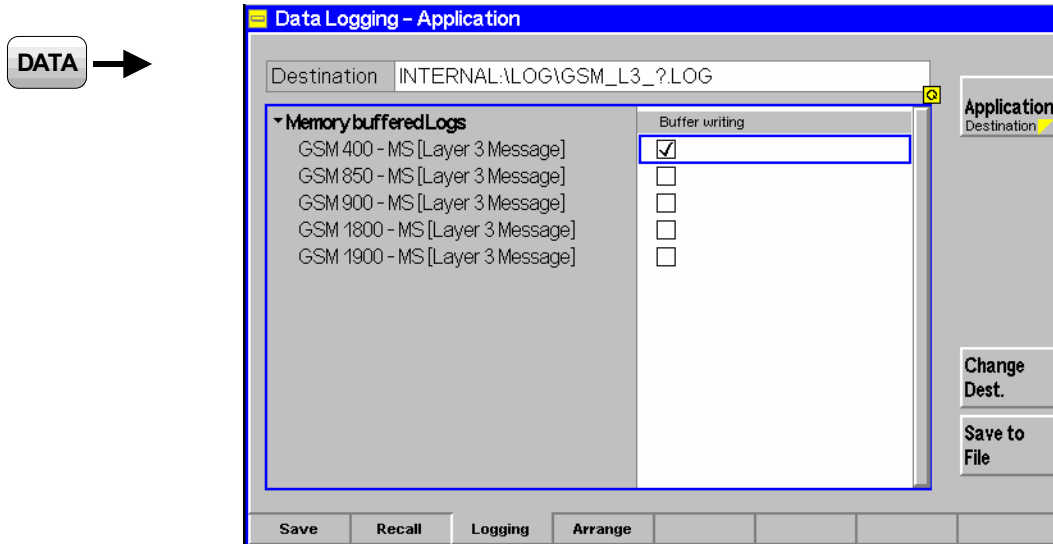
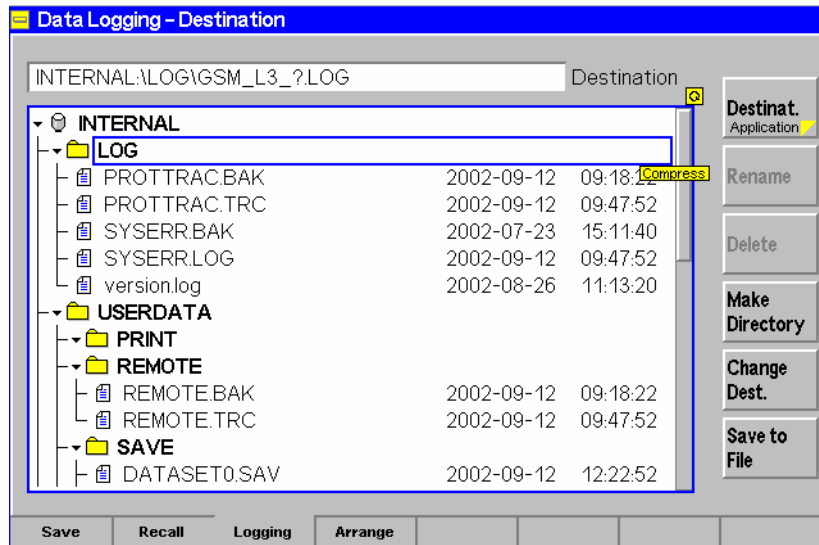

Fig. 4-17 Data – Logging menu

Application
Destination

Application/Destination toggles between the overview of available GSM networks (see Fig. 4-17 above) and a view of the directories available for storing the log file (*.LOG). The *Destination* view is analogous to the *Arrange* tab; see section *File Manager (Data – Arrange)* on p. 4.37 ff.



Remote control

–

Buffer Writing

The checkboxes in the *Buffer Writing* column control data recording in the five different GSM networks supported by the instrument.

If buffer writing is enabled for a particular GSM network (box checked), the GSM layer 3 uplink and downlink messages transferred during a *GSM-MS Signalling* test session are stored in a ring buffer. The buffer size corresponds to approx. 3200 messages. Message types that are connected with information displayed in the CMU measurement menus, e.g. the MS receiver reports, are not recorded. Recording is continued even after a handover or a change of the network.

The contents of the ring buffer can be written to a binary file any time (even while *Buffer Writing* is enabled); see *Save to File* softkey below. Saving the buffer contents clears the buffer. On the other hand the buffer is not cleared when *Buffer Writing* is enabled.

Remote control:

The commands for the layer 3 message log belong to the *GSMxxx-MS Signalling* function groups:

```
MMEMoRY:L3Msg:BWRiting ON | OFF
```

**Change
Dest.**

The *Change Dest.* softkey opens a dialog to specify the name and path of the created log file.

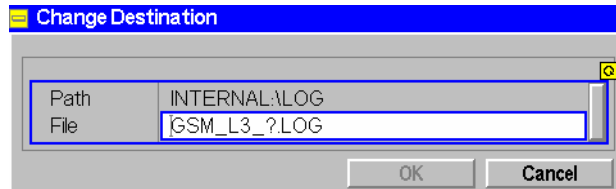

Editing the *Change Destination* dialog is optional: By default, the CMU stores log files to the directory *INTERNAL\LOG* and uses the file names *GSM_L3_?.LOG* where the question mark is replaced by current numbers that are automatically incremented, starting with zero (auto-increment function). To create more than 10 different log files, another name or destination must be specified.

Note: *A second or third question mark in the file name extends the auto-increment function so that up to 999 logging files can be stored. Keep in mind the memory of the internal hard disk when using this feature.*

Selecting *OK to Save* closes the dialog window and stores the inputs made. Pressing *Cancel* or *Change Dest.* again without selecting *OK to Rename* closes the dialog box, discarding all inputs made.

Remote control

The commands for the layer 3 message log belong to the *GSMxxx-MS Signalling* function groups:

```
MMEMoRY:L3Msg:CDEStination <FileName> [,<msus>]
```

**Save to
File**

Save to File saves the current ring buffer content to the log file specified via *Change Dest.* and clears the ring buffer.

Note: *The contents of the ring buffer are also saved when the instrument is shut down, i.e. after pressing Alt+F4 on instruments equipped with a FMR 5 or during the normal shutdown process (ON/STANDBY key; "Shutdown in progress...") on instruments equipped with a FMR 6. To distinguish files created during shutdown from ordinary log files they are named GSM_L3_?.SAV where the ? is auto-incremented.*

Remote control

The commands for the layer 3 message log belong to the *GSMxxx-MS Signalling* function groups:

```
MMEMoRY:L3Msg:SAVe <FileName> [,<msus>]
```

```
MMEMoRY:L3Msg:BEmpTy?
```

Transfer and Evaluation of Log Files

A log file can be transferred to a PC using the functions of the *Arrange* tab (see section [File Manager \(Data – Arrange\)](#) on p. 4.37 ff.) or via GPIB bus using the `MMEMoRY:DATA` command. Rohde & Schwarz provides an evaluation software tool for log files, the *Message Viewer* (option R&S CMU-Z49; the

extended version R&S CRTU GP01, stock no. 1139.7590.02, allows to edit layer 3 messages). After loading the log file into the *Message Viewer*, the information can be evaluated as shown in the following examples. For more information please refer to the operating manual or help for the *Message Viewer*.

| Dir | Name | Base... | phys.... | log.... | TS N... | Frame... | Block |
|-----|----------------------------|---------|----------|---------|---------|---------------|-------|
| T | System Info Type 1 | 0 | 0 | ????... | | 0 ... | |
| T | System Info Type 2 | 0 | 0 | ????... | | 0 ... | |
| T | System Info Type 3 | 0 | 0 | ????... | | 0 ... | |
| T | System Info Type 4 | 0 | 0 | ????... | | 0 ... | |
| T | System Info Type 13 | 0 | 0 | ????... | | 0 ... | |
| R | DL-RA-Ind | 0 | 0 | ????... | | 0 ... | |
| T | Immediate Assignment | 0 | 0 | ????... | | 0 ... | |
| R | Location Updating Req | 0 | 0 | ????... | | 0 ... | |
| T | Classmark Enquiry | 0 | 0 | ????... | | 0 ... | |
| R | Classmark Change | 0 | 0 | ????... | | 0 ... | |
| T | Identity Request | 0 | 0 | ????... | | 0 ... | |
| R | Identity Response | 0 | 0 | ????... | | 0 ... | |
| T | Identity Request | 0 | 0 | ????... | | 0 ... | |
| R | Identity Response | 0 | 0 | ????... | | 0 ... | |
| T | Location Updating Accept | 0 | 0 | ????... | | 0 ... | |
| R | TMSI Reallocation Complete | 0 | 0 | ????... | | 0 ... | |
| T | Channel Release | 0 | 0 | ????... | | 0 ... | |
| R | DL-RA-Ind | 0 | 0 | ????... | | 0 ... | |
| T | Immediate Assignment | 0 | 0 | ????... | | 0 ... | |
| R | GMM Attach Request | 0 | 0 | ????... | | 0 ... | |
| T | Packet Uplink Ack | 1 | 2 | GPRS | | 0 ... [0, 0] | |
| R | Packet Control Ack | 1 | 2 | GPRS | | 0 ... [0, 0] | |
| T | Immediate Assignment | 0 | 0 | ????... | | 0 ... | |
| R | GMM Attach Accept | 0 | 0 | ????... | | 0 ... | |
| R | Packet Downlink Ack | 1 | 2 | GPRS | | 0 ... [0, 0] | |
| R | Packet Downlink Ack | 1 | 2 | GPRS | | 0 ... [0, 0] | |

| Name | Bitfields | Comment |
|-----------------------------|---------------------|--------------------------------|
| TX Location Updating Accept | | BS=0, PC=0, LC=????????, , 0 |
| Protocol Discriminator | | |
| Protocol Discriminator | - - - - 0 1 0 1 | Mobility management |
| Skip Indicator | | |
| Skip Indicator | 0 0 0 0 - - - - | Skip Indicator 0 |
| Message Type | | |
| Spare 1 | 0 - - - - - - - - | 1 spare bit 0 |
| N(SD) | - 0 - - - - - - - - | Send sequence number 0 |
| Message Type | - - 0 0 0 0 1 0 | Message type 2 |
| Location Area ID | | |
| MCC 2 | 0 0 0 0 - - - - | Mobile Country Code digit 2 0 |
| MCC 1 | - - - - 0 0 0 0 | Mobile Country Code digit 1 0 |
| MCC 4 | 1 1 1 1 - - - - | Mobile Country Code digit 4 15 |
| MCC 3 | - - - - 0 0 0 1 | Mobile Country Code digit 3 1 |
| MNC 2 | 0 0 0 1 - - - - | Mobile Network Code digit 2 1 |
| MNC 1 | - - - - 0 0 0 0 | Mobile Network Code digit 1 0 |
| LAC | 0 0 0 0 0 0 0 0 | Location area code 1 |
| LAC | 0 0 0 0 0 0 1 | |
| Mobile Identity | present | (IRI) : |
| N | 0 0 0 0 0 1 0 1 | CIR length in no of bytes 5 |
| Identity Digit P | 1 1 1 1 - - - - | Identity Digit P 15 |
| Odd Even Indication | - - - - 0 - - - | Even no. of ID digits |
| Type of identity | - - - - 1 0 0 | TMSI/P-TMSI |
| Identity Digit P+1 | 0 0 0 1 - - - - | Identity Digit P+1 1 |
| Identity Digit P | - - - - 0 0 1 0 | Identity Digit P 2 |
| Identity Digit P+1 | 0 0 1 1 - - - - | Identity Digit P+1 3 |
| Identity Digit P | - - - - 0 1 0 0 | Identity Digit P 4 |
| Identity Digit P+1 | 0 1 0 1 - - - - | Identity Digit P+1 5 |
| Identity Digit P | - - - - 0 1 1 0 | Identity Digit P 6 |
| Identity Digit P+1 | 0 1 1 1 - - - - | Identity Digit P+1 7 |
| Identity Digit P | - - - - 1 0 0 0 | Identity Digit P 8 |
| Follow On Proceed | omitted | |
| CTS Permission | omitted | |

Fig. 4-18 Evaluation of log files

File Manager (Data – Arrange)

The *Arrange* tab in the *Data* popup menu manages the files in the internal and external memories that can be used for mass storage. The menu is particularly useful for handling files containing user data such as:

- Screenshots (*.wmf or printer format, see section *Print Menu (PRINT Menu)* on p. 4.5)
- Remote report files (ASCII text files, see description of the remote screen in Chapter 5) and log files (special binary *.log format, see section *Layer 3 Message Log (Data – Logging)* on p. 4.33 ff.)

An extended file management functionality is available in remote control; see `MMEMORY` system in Chapter 6.

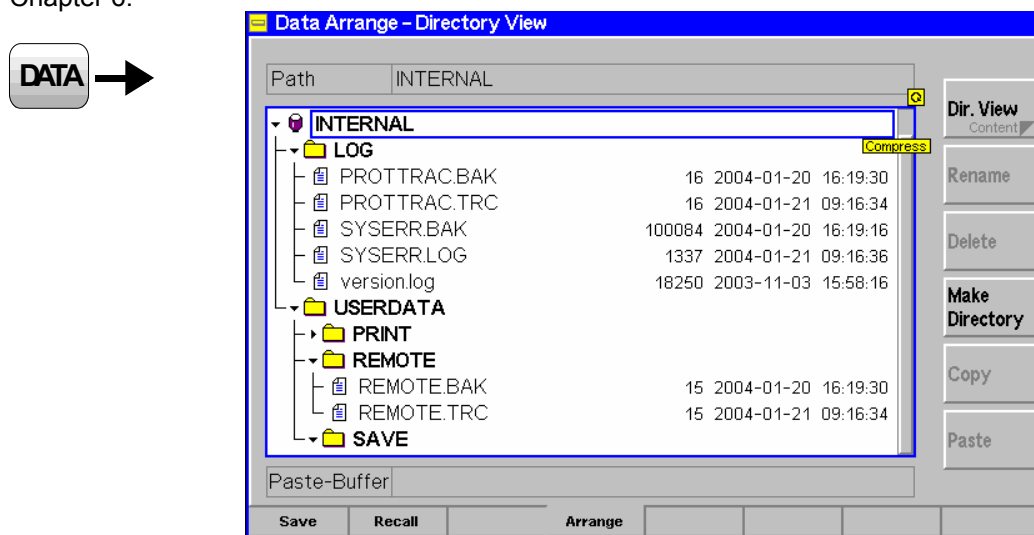

Fig. 4-19 Data – Arrange menu

File selection

The stored files can be selected from a tree view in the center of the menu. The tree can be expanded and compressed using the roll-key and the *ON/OFF* key (see Chapter 3, *Expanding menu tables*). It starts from the nodes for the *EXTERNAL* and *INTERNAL* mass storage devices:

EXTERNAL

Root directory of the external storage device. Depending on the instrument configuration, this can be a floppy disk or a CF / PCMCIA memory card, inserted in slot 0 (right side) of the CF / PCMCIA interface. The *Data* menu does not discriminate between the two slots. If an attempt is made to expand the *EXTERNAL* directory while no external storage device is present, the CMU displays the following message:



- *Accept* the message, insert a suitable storage device and try again to expand the *EXTERNAL* directory and view its contents.

INTERNAL

Root directory of the section on the internal hard disk that is reserved for mass storage.

File indication /
Paste Buffer

The output field above the tree view shows the path and name of the selected file. The *Paste Buffer* field below the tree view shows the path and name of a file that has been cut or copied to be pasted into another directory.

Remote control

MMEMemory:MSIS INTernal | EXTernal

Dir. View
Content

Dir. View/Content toggles between the directory view (see [Fig. 4-19 above](#)) and the overview of function groups and test modes contained in a configuration file (*.SAV). The *Content* view is available for configuration files only:

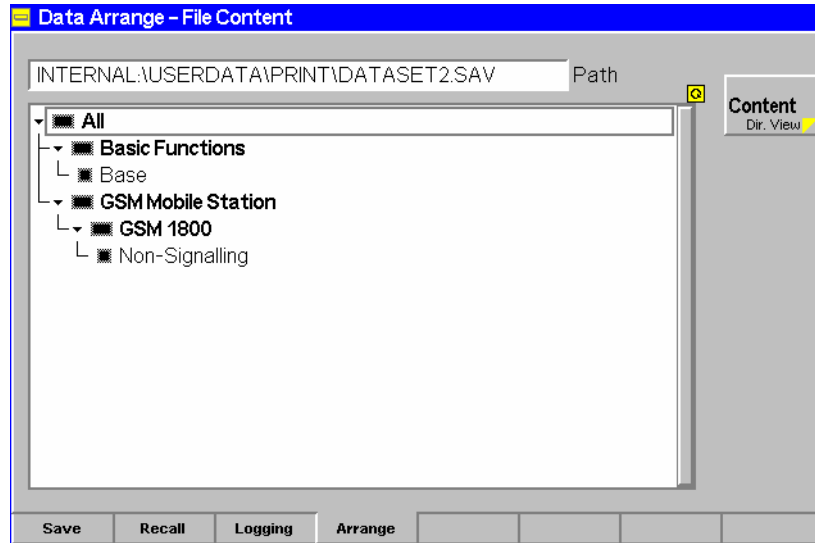

The *Content* view shows the path and name of the configuration file and all function groups and test modes contained in the file. The tree view is for information only. It is analogous to the trees in the *Reset* menu (see section [Reset of Instrument Settings \(RESET Key\)](#) on p. 4.3.) and in the *Save* and *Recall* tabs of the *Data* menu, however, it only shows the function groups and test modes actually contained in the configuration file so that all rectangular symbols are black.

Remote control

—

View Info
Rename

The *View Info/Rename* softkey opens a dialog to display and edit file information or assign a new name to the selected file or to a subdirectory.

The labeling of the softkey and its function depends on the selected node in the directory view:

- If a file is selected the softkey reads *View Info/Rename*. It opens a popup window showing the *Root* directory, the *Directory* plus other file information. The file *Name* and a *Comment* to be stored with the file can be edited. This can be done with the *DATA* keys on the front panel and the auxiliary editor (see Chapter 3) or even more conveniently using an external keyboard. The *Status* shows either *File OK* (for configuration files *.SAV) or *Not a compatible file type* (for all other file types).

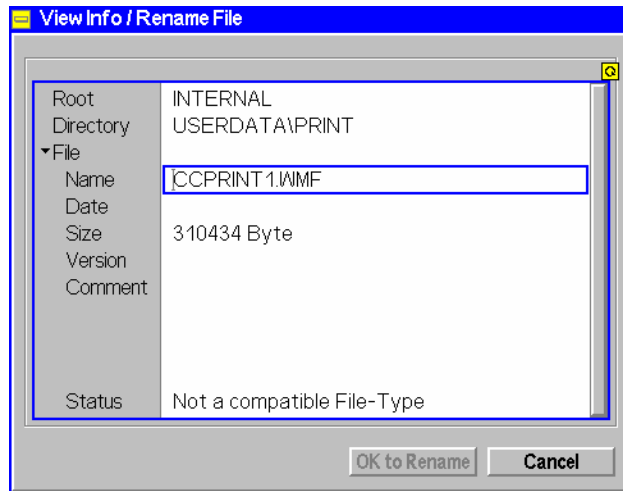

- If a directory is selected, no particular information is needed so the softkey reads *Rename*. It opens a popup window to rename and move the directory by editing the *Path* and the *Directory* name. The path can be entered according to DOS conventions, if so desired. *Rename* is disabled (grayed) while the *EXTERNAL* and *INTERNAL* root directories or the reserved directories *Log*, *Userdata*, *Print*, *Remote*, *Save* are selected (the reserved directories are used internally to store important info files). Moreover, the maximum number of directory levels below the *EXTERNAL* and *INTERNAL* root directories is 5.

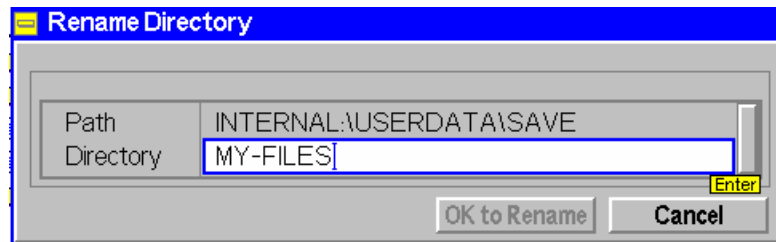

Selecting *OK to Rename* closes the dialog windows and renames the file or directory. Pressing *Cancel* or *View Info/Rename* again without selecting *OK to Rename* closes the dialog box without renaming the file.

Remote control

```
MMEMemory:INFO? <FileName> [,<msus>]
MMEMemory:MOVE <FileSource>[,<msus1>], <FileDest> [,<msus2>]
```



The *Delete* softkey deletes the selected file or directory. Before an individual file is deleted, the R&S® CMU generates a warning:

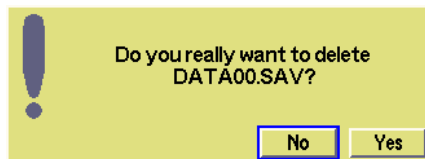

Before a directory is deleted, the R&S® CMU generates a similar warning:

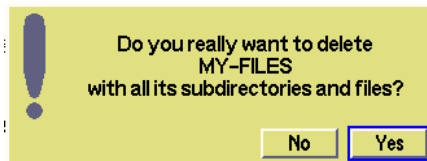

Selecting *Yes* deletes the file or directory; selecting *No* closes the warning messages without deleting.

Remote control

```
MMEMory:DElete <FileName>, [INTernal | EXTernal]
MMEMory:RMDir <DirName>, [INTernal | EXTernal]
```

Make Directory

The *Make Directory* softkey creates a new directory. The name and path of the new directory are entered into a *Make Directory* dialog box; see *Rename Directory* above.

Remote control

```
MMEMory:MKDir <Dir_Name>[,<msus>]
```

Copy

The *Copy* softkey stores the selected file or directory into the *Paste Buffer* so it can be copied to other directories (see *Paste* softkey below). The original file or directory is not deleted, so the *Copy* function duplicates a file or a directory with all its contents.

Remote control

```
No direct equivalent. To replace the Copy/Paste mechanism use the command
MMEMory:COPY <FileSource>[,<msus1>], <FileDest> [,<msus2>]
```

Paste

The *Paste* softkey stores the file or directory copied into the *Paste Buffer* to the current directory. It is disabled (grayed) if the *Paste Buffer* is empty. A copied file can be stored several times to different directories and storage devices. Pasting the file does not affect the *Paste Buffer*. If the current directory contains a file or subdirectory with the same name; a warning is generated:



Selecting *Yes* overwrites the existing file or directory; selecting *No* closes the warning message without pasting the content of the buffer.

Remote control

```
No direct equivalent. To replace the Copy/Paste mechanism use the command
MMEMory:COPY <FileSource>[,<msus1>], <FileDest> [,<msus2>]
```

RF Measurements (RF)

This section describes the measurement and configuration menus of function group *RF*. It is organized as follows:

- Configuration of the RF output signal, RF analyzer settings and general power measurements (*Analyzer/Generator*).
- Graphical measurement menus (*Power versus Time* and *Spectrum*): Measurement menus, results, configuration menus.
- General configurations (*Connection Control*).

The most important menus of the *RF* function group are shown in an overview at the end of Chapter 3 in the present R&S® CMU manual.

Analyzer/Generator Menu

The main menu *Analyzer/Generator* configures the RF generator and analyzer and displays the power of the received RF signal.

- The measurement control softkey *Analyzer Power* changes to *Power Meter Freq. Sel.*, depending on the application selected. This softkey controls the measurement, indicates its status (*RUN* | *HLT* | *OFF*) and opens the configuration menu *Analyzer/Generator Configuration*. The hotkeys associated with the measurement control softkey define the scope of the *Analyzer/Generator* measurement.
- The other softkeys on the right side are combined with various hotkeys (e.g. the hotkeys *Frequency* and *RBW* belong to the softkey *Analyzer Settings*). The softkey/hotkey combinations provide test settings and switch over between different measurements.

The *RF* function group provides different types of power measurements. All power measurements are performed at fixed frequency. They differ in their measurement principle and filter settings, in the statistical evaluation and the display of results.

Analyzer Power

Analyzer Power is an application in the *Analyzer/Generator* menu. The measurement yields the average power of an RF input signal over a sweep; see section [Measurement Results](#) on p. 4.45.

A wide range of measurement filters including a wideband filter is available. The accuracy of the *Analyzer Power* (including the wideband power) measurement is enhanced if the center frequency of the analyzer matches the frequency of the measured signal. The characteristics of the *Analyzer Power* measurement makes it particularly suitable for the analysis of CW signals where no measurement curves are needed.

Power Meter Freq. Sel.

Power Meter Freq. Sel. is the second application in the *Analyzer/Generator* menu. The measurement yields the average, minimum and maximum power of an RF input signal over a sweep plus a statistical evaluation over several consecutive sweeps; see section [Measurement Results](#) on p. 4.45.

A wide range of measurement filters including the filters specified for TDMA and CDMA conformance tests is available. The measurement is always frequency selective; no wideband filter is provided. The measurement time depends on the filter bandwidth but never exceeds the order of magnitude of 100 ms for a single sweep. The frequency of the RF signal is also measured, provided that is close enough to the selected measurement frequency.

The characteristics of the *Power Meter Freq. Sel.* measurement makes it particularly suitable for the analysis of CW signals where no measurement curves are needed.

| | |
|--|--|
| Pow. Meter Wideband | <p><i>Pow. Meter Wideband</i> is displayed in the <i>RF</i> connector tab of the <i>Connection Control</i> menu. The measurement is performed at the RF Frontend of the CMU and yields the peak power of the input signal inside a wide frequency range. For modulated RF signals, the result of the wideband power measurement depends on the modulation characteristics.</p> <p>The main purpose of the measurement is to indicate whether an input signal is available and whether it is advisable to change the <i>Max Level</i> settings.</p> |
| Power vs. Time | <p>The <i>Power vs. Time</i> measurement yields the power of the RF input signal over a variable time range. The result is displayed in a graphical diagram.</p> <p>The measurement is performed at fixed frequency. A wide range of Gaussian measurement filters is available. The <i>Power vs. Time</i> measurement can be used to analyze an RF signal with variable power, e.g. a burst signal.</p> |
| Types of settings | <p>The purpose of the <i>Analyzer/Generator</i> menu is to provide quick access to the most common RF analyzer and generator settings and to present the basic power results at a glance. Two measurement applications <i>Analyzer Power</i> or <i>Power Meter Freq. Sel.</i> can be selected with the <i>Application</i> softkey. The remaining softkey/hotkey combinations provide two different types of settings:</p> <ul style="list-style-type: none"> • General settings are valid for all applications of the RF function group. Changing general settings in any application will have an impact on all measurements and applications of the function group. All general settings are also provided in the <i>Connection Control</i> menu (see p. 4.66). Examples of general settings are the <i>RF Max. Level</i> and the trigger settings (softkey <i>Analyzer Level</i>) and the configuration of the RF generator (softkey <i>Generator</i>). • Specific settings are relevant for one application only, or they can be set independently for several applications. Changing specific settings in an application will not affect the other measurements and applications of the function group. No specific settings are provided in the <i>Connection Control</i> menu (see p. 4.66). Examples of specific settings are the <i>Repetition</i> mode (to be set independently for all applications) and <i>Statistic Count</i> (not relevant for the <i>Analyzer Power</i> application). |
| Measurement results | <p>The output fields in the left half of the <i>Analyzer/Generator</i> menu show the current measurement results. The results depend on the selected application. They are described in detail in section Measurement Results on p. 4.45.</p> <p>The results displayed in the <i>Analyzer/Generator</i> menu represent only a small fraction of the power results that the CMU is able to acquire. More results are displayed in the <i>Power</i> and <i>Spectrum</i> measurement menus. In particular, the <i>Power</i> and <i>Spectrum</i> menus show the results as a function of time and frequency.</p> |
| Note: | <p><i>An additional wideband power measurement menu is provided in the Connection Control menu; see Pow. Meter Wideband softkey on p. 4.86.</i></p> |
| <p>The main menu <i>Analyzer/Generator</i> is opened from the main menu <i>Menu Select</i> (with associated key at front of instrument). It can also be accessed from the other measurement menus of the function group <i>RF</i> via the <i>Ana./Gen.</i> hotkey.</p> | |

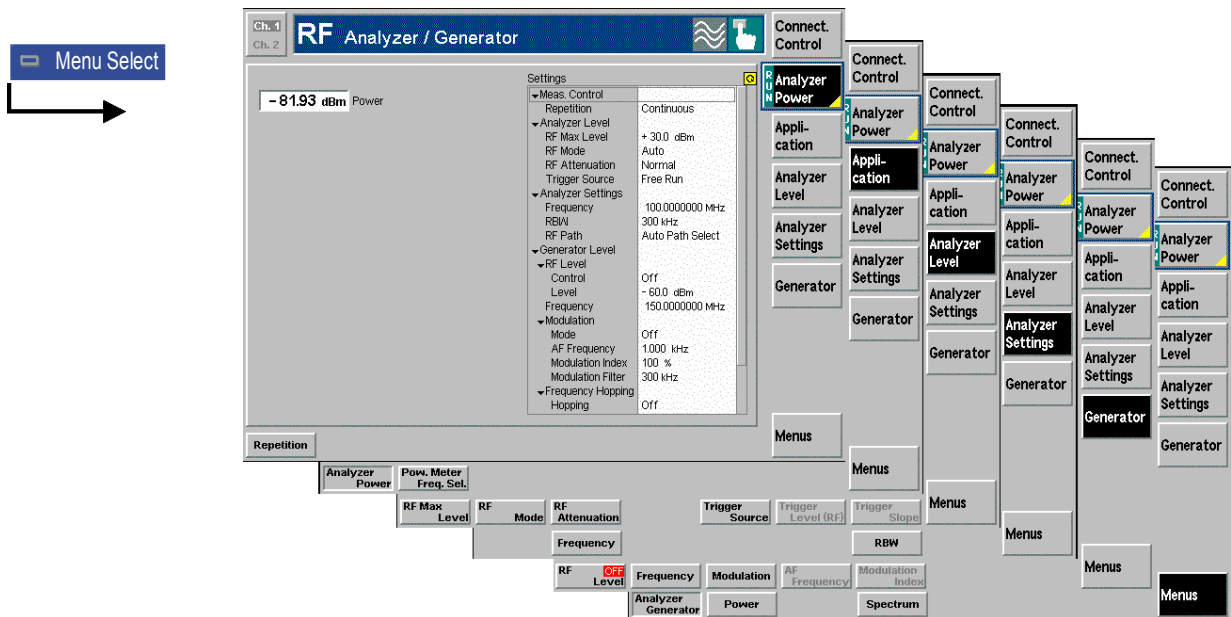

Fig. 4-20 Measurement menu Analyzer / Generator

Test Settings

The settings for the *Analyzer/Generator* menu are accessible via softkey/hotkey combinations. If a softkey (located in the softkey bar on the right side of the menu) is selected and an associated hotkey (displayed across the bottom of the menu) is pressed, a popup window indicating the current setting and enabling an entry will appear.

Example:

Analyzer Settings

The *Analyzer Settings* softkey displays a hotkey bar including the hotkey labeled *Frequency*.

Frequency

The *Frequency* hotkey opens the input window *Frequency*.



Input windows indicate the current parameter value (in this case: the current RF input frequency) or a list of the possible settings. Parameters are changed by

- Overwriting/incrementing numerical values (for numerical parameters)
- Selecting from the list of parameters (for select parameters)

Each *Analyzer/Generator* application is controlled by means of the measurement control softkey below the *Connect. Control* softkey and the associated hotkeys.

Analyzer Power

The *Analyzer Power* softkey (which changes to *Power Meter Freq. Sel.*, depending on the application selected) controls the measurement application and indicates its state (*RUN | HLT | OFF*). This state can be changed after softkey selection (pressing once) by means of the *ON/OFF* key or the *CONT/HALT* key. The state can be set independently for all three applications.

Remote control

| | |
|--------------------------|----------------------|
| INITiate:RFANalyzer | INITiate:NPOWer |
| ABORt:RFANalyzer | ABORt:NPOWer |
| STOP:RFANalyzer | STOP:NPOWer |
| CONTinue:RFANalyzer | CONTinue:NPOWer |
| FETCh:RFANalyzer:STATus? | FETCh:NPOWer:STATus? |

Measurement configuration

Pressing the *Analyzer Power* softkey twice opens the popup menu *Analyzer/Generator Configuration* (see page 4.46).

Besides a number of hotkeys defining the scope of the measurement are associated with the *Analyzer Power* softkey. The corresponding settings are specific to the *Analyzer/Generator* menu and also provided in the *Control* tab of the *Analyzer/Generator Configuration* menu; see section [Analyzer/Generator Configuration](#) on p. 4.46.

Application

The *Application* softkey selects the measurement application. The measurement control softkey (second softkey below *Connect. Control*) indicates the current application. Some of the hotkeys associated with the different softkeys, the *Setup* table, and the results in the *Analyzer/Generator* menu also vary as a function of the application. Details about the measurements and the results are explained in section [Measurement Results](#) on p. 4.45.

Analyzer Power

The *Analyzer Power* hotkey selects the measurement of the peak power using a filter with variable bandwidth or a wideband filter. In this application no statistical evaluation of the results is provided.

Remote control

The *Analyzer Power* application corresponds to the `RFANalyzer` subsystem.

Pow. Meter Freq. Sel.

The *Pow. Meter Freq. Sel.* hotkey selects the measurement of the peak and average power using a wide selection of narrow-band (and therefore frequency selective) filters. In this application a statistical evaluation of the results is provided.

Remote control

The *Pow. Meter Freq. Sel.* application corresponds to the `NPOWer` subsystem.

Analyzer Level

The *Analyzer Level* softkey controls the level in the RF input signal path and provides the trigger settings for the current measurement.

The input level and trigger settings are general settings and therefore also provided in the *Connection Control* menu. They are described in more detail in sections [Analyzer Settings \(Connection Control – Analyzer\)](#) on p. 4.73 on page 4.73 and [Trigger \(Connection Control – Trigger\)](#) on p. 4.92.

Analyzer Settings

The *Analyzer Settings* softkey determines the center frequency of the RF analyzer and the resolution bandwidth of the measurement filter. The settings are specific to the *Analyzer/Generator* menu and also provided in the *Control* tab of the *Analyzer/Generator Configuration* menu; see section [Analyzer/Generator Configuration](#) on p. 4.46.

Generator
Tx Aux Tx

The *Generator* softkey configures the RF signals generated. The generator settings are general settings and therefore also provided in the *Connection Control* menu. They are described in more detail in section [Generator Settings \(Connection Control – Generator\)](#) on p. 4.76.

The *RF Level* hotkey is also used to switch the RF generator on and off. If one of the options R&S CMU-B95 or R&S CMU-B96, *Second RF Generator*, is fitted, the *Generator* softkey toggles between the primary RF signal (*Tx*) and the auxiliary RF signal (*Aux Tx*) settings. The properties of the *Aux Tx* signal are also described in section

[Generator Settings \(Connection Control – Generator\)](#) on p. 4.76.

Settings table

The *Settings* table in the right half of the *Analyzer/Generator* menu gives an overview of the measurement settings belonging to the current application. It changes when a different application is selected. The rotary knob scrolls and expands the *Settings* table.

Measurement Results

The results displayed in the *Analyzer/Generator* menu depend on the selected application. All results are obtained at a definite frequency and resolution bandwidth; see [Analyzer Settings](#) softkey on p. 4.44.

Analyzer Level:

The result for the *Analyzer Level* application appears in a single output field.



The indicated *Power* is the power of the RF input signal measured at the selected frequency and RBW and averaged over a basic evaluation period/sweep of 4096 samples. The result is updated after each sweep.

Remote control

FETCh[:SCALar]:RFAnalyzer:POWer?

Pow. Meter Freq. Sel.:

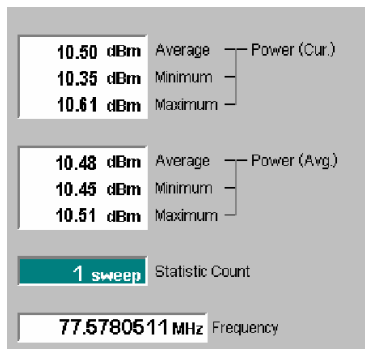

The results for the frequency selective power meter (*Pow. Meter Freq. Sel.*) application are displayed in several groups of output fields. All results are obtained at the selected frequency and RBW. The statistical evaluation is based on a basic evaluation period/sweep of 4096 samples and on the statistics cycle (*Statistic Count*) defined in the configuration menu (see section [Analyzer/Generator Configuration](#) on p. 4.46; for a general description of statistical evaluations in the R&S® CMU refer to Chapter 3, section *General Settings*).

Power (Curr.) Average, minimum and maximum power of the RF input signal in the current sweep

Power (Avg.) Average, minimum and maximum of the *Power (Curr.)* values: The *Maximum (Minimum)* value is the largest (smallest) power ever measured in the current measurement. *Average* is the average over all *Average – Power (Curr.)* values in the current measurement, obtained according to the averaging rules described in Chapter 3, section *General Settings*.

Statistic Count Number of sweeps per statistics cycle. The colored bar indicates the relative measurement progress in the statistics cycle

Frequency Frequency of the RF input signal. The frequency can be measured with an accuracy of 0.1 Hz.

Remote control

```
READ[:SCALar]:NPOWer?
FETCh[:SCALar]:NPOWer?
SAMPle[:SCALar]:NPOWer?
```

Analyzer/Generator Configuration

The popup menu *Analyzer/Generator Configuration* configures the RF analyzer measurements. It is opened by pressing the *Analyzer Power* measurement control softkey in the *Analyzer/Generator* menu twice.

In the *Control* tab of the *Analyzer/Generator Configuration* menu both power measurement applications of the *Analyzer/Generator* menu can be configured independently. The tab defines:

- The center *Frequency* of the RF analyzer
- The Repetition mode
- The *Statistic Count* for the measurement (for the *Power Meter Freq. Sel.* measurement only)
- The *Resolution Bandwidth* of the measurement filter

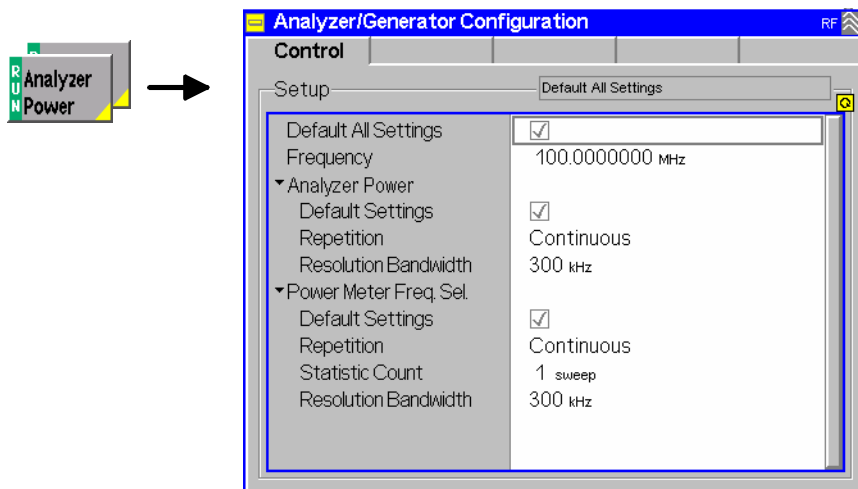

Fig. 4-21 Analyzer/Generator Configuration – Control

Default Settings The *Default All Settings* switch assigns default values to all settings in the *Control* tab (the default values are quoted in the command description in chapter 6 of this manual). In addition, default switches for the individual applications are provided.

Remote control

–

Frequency *Frequency* defines the center frequency of the RF analyzer. This setting is valid for both *Analyzer/Generator* measurement applications.

Remote control

```
[SENSe:]RFANalyzer:FREQuency <Frequency>
```

Resolution Bandwidth

Resolution Bandwidth defines the resolution bandwidth of the analyzer. The nominal resolution bandwidth is the 3-dB bandwidth of the measurement filter. The bandwidths available depend on the measurement application:

- For both applications, a list of Gaussian filters with discrete bandwidths between 10 Hz and 1 MHz is available. The frequencies in the list are given by 1×10^n Hz, 2×10^n Hz, 3×10^n Hz, 5×10^n Hz where $n=1$ to 5. In addition the value 1 MHz is provided.
- The *Analyzer Power* measurement can be performed with a *WIDE* resolution bandwidth (denoting measurement at the front end with no restriction of the analyzer frequency and level). The wide-band measurement is most accurate if the correct center frequency is set.
- The *Pow. Meter Freq. Sel.* measurement can be performed with the root-raised cosine filter specified in standard TIA/EIA-136.xxx (*TDMA* filter) or with an 1.4 MHz bandpass filter specified for CDMA measurements (*CDMA* filter).

Resolution bandwidths for the *Power* and *Spectrum* measurements can be set independently.

Remote control

```
[SENSe:]RFANalyzer:BWIDth[:RESolution] <Bandwidth>
[SENSe:]NPOWer:BWIDth[:RESolution] <Bandwidth>
```

Repetition

Repetition determines the repetition mode (see Chapter 3). Repetition modes for the applications *Analyzer Power* and *Power Meter Freq. Sel.* can be set independently.

Single Shot

Single-shot measurement: the measurement is stopped after one sweep comprising 4096 samples. A stopped measurement is indicated by the status display *HLT* in the *Power* softkey.

Continuous

Continuous measurement: The R&S® CMU measures continuously until the measurement is explicitly stopped via the measurement control softkey in the graphical measurement menu (see [Analyzer Power](#) softkey on p. 4.44). The measurement results are valid after one sweep; however, the measurement is continued, and the output is continuously updated. An ongoing measurement is indicated by the status display *RUN* in the *Power* softkey.

Single shot should always be selected if only a single measurement result is required under fixed conditions. The continuous measurement is suitable for monitoring the evolution of a measured quantity in time, for example for adjustments.

Note: *In remote mode, the counting measurement (counting mode) is available as a further repetition mode with a defined number of measurement cycles to be performed, see chapter 6 of this manual.*

Remote control

```
CONFigure:RFANalyzer:CONTRol:REPetition
```

```
CONTInuous | SINGleshot | 1 ... 10000,NONE,<Stepmode>
```

```
CONFigure:NPOWer:CONTRol:REPetition
```

```
CONTInuous | SINGleshot | 1 ... 10000,NONE,<Stepmode>
```

Statistic Count

Statistic Count defines how many sweeps are combined to form one statistics cycle. Each sweep consists of 4096 samples. This setting is available for the *Power Meter Freq. Sel.* application; for *Analyzer Power* measurements the *Statistic Count* is always equal to one.

1 to 1000 sweeps Number of sweeps per statistics cycle

The settings *1* and *OFF* (press *ON/OFF* key) are equivalent. A statistics cycle determines the duration of single-shot measurements (see Chapter 3, section *General Settings*).

Remote control

```
CONFigure:NPOWer:CONTRol:STATistics 1 ... 1000 | NONE
```

Power vs. Time Measurement

The menu group *Power* is designed to measure the RF signal power as a function of time (oscillographic representation measured at a specific frequency, e.g. for burst analysis). The popup menu *Power Configuration* is used for configuration of the measurements; the measurement results are displayed in the graphical measurement menu *Power*.

Note: The RF function group provides a wide selection of power measurements. For an overview see section *Analyzer/Generator* on p. 4.41.

Measurement Menu (Power)

The graphical measurement menu *Power* displays the results of the power measurement in the time domain.

- The main softkey *Power* controls the measurement, indicates its status (*RUN* | *HLT* | *OFF*) and opens the configuration menu *Power Configuration*. The hotkey associated with the main softkey define the scope of the *Power* measurement.
- The other softkeys to the right of the test diagram are combined with various hotkeys (e.g. the hotkeys *Frequency* and *RBW* belong to the softkey *Analyzer Settings*). The softkey/hotkey combinations provide test settings and display configurations.

The measurement menu *Power* is opened from the main menu *Menu Select* (with the associated key at the front of the instrument) or using the *Power* hotkey.

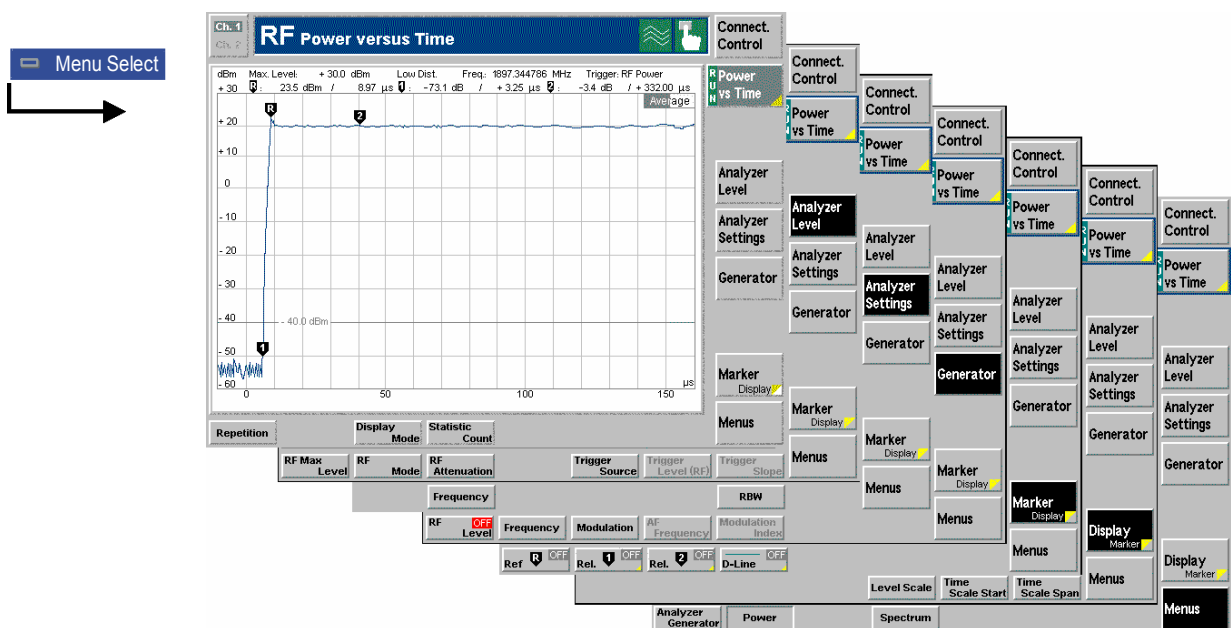

Fig. 4-22 Measurement menu Power

Test settings

The basic settings for the *Power* measurement are directly accessible from the measurement menu via softkey/hotkey combinations. The entry of values is described in section [Test Settings](#) on p. 4.43.

Some of the basic settings are also accessible from the *Power Configuration* popup menu. They are explained in more detail in the [Measurement Configurations \(Power Configuration\)](#) section on page 4.53.

Power vs Time

The *Power vs Time* softkey controls the power measurement and indicates its status (*RUN* | *HLT* | *OFF*). This status can be changed after softkey selection (pressing once) by means of the *ON/OFF* key or the *CONT/HALT* key.

Remote control

```
INITiate:POWer; ABORt:POWer; STOP:POWer; CONTINUE:POWer
FETCh:POWer:STATus?
```

Measurement configuration

Pressing the *Power vs Time* softkey twice opens the popup menu *Power Configuration* (see page 4.53). Besides, the measurement control softkey provides hotkeys to define the scope of the measurement. All these settings are described in more detail in section [Measurement Configurations \(Power Configuration\)](#) section on page 4.53.

Analyzer Level

The *Analyzer Level* softkey controls the level in the RF input signal path and provides the trigger settings for the current measurement.

The input level and trigger settings are general settings and therefore also provided in the *Connection Control* menu. They are described in more detail in sections [Analyzer Settings](#) on page 4.73 and [Trigger \(Connection Control – Trigger\)](#) on p. 4.92.

Analyzer Settings

The *Analyzer Settings* softkey determines the center frequency of the RF analyzer and the resolution bandwidth of the measurement filter. The settings are specific to the *Power* menu and also provided in the *Control* tab of the *Power Configuration* menu; see section [Measurement Configurations \(Power Configuration\)](#) section on page 4.53.

Generator Tx Aux Tx

The *Generator* softkey configures the RF signals generated. The generator settings are general settings and therefore also provided in the *Connection Control* menu. They are described in more detail in section [Generator Settings \(Connection Control – Generator\)](#) on p. 4.76.

The RF Level hotkey is also used to switch the RF generator on and off.

If one of the options R&S CMU-B95 or R&S CMU-B96, *Second RF Generator*, is fitted, the *Generator* softkey toggles between the primary RF signal (*Tx*) and the auxiliary RF signal (*Aux Tx*) settings. The properties of the *Aux Tx* signal are also described in section

[Generator Settings \(Connection Control – Generator\)](#) on p. 4.76.

| |
|--------------------------|
| Marker Display |
|--------------------------|

The *Marker/Display* softkey positions up to 3 markers and a D-line in the test diagram and displays their values.

If pressed once again, the selected *Marker/Display* softkey changes to the *Display/Marker* softkey, see below.

Markers are graphical tools for marking points on the measurement curve and for numerical output of measured values. The measurement menu Power provides a reference marker and two further markers which permit to measure differences (delta marker 1 and 2). The coordinates of the three markers are indicated in the format Ordinate value (level)/abscissa value (time) in a parameter line above the test diagram. The position of the reference marker is expressed in absolute units (level in dBm and time in bits), the delta marker by absolute or relative values (relative level in dB or time differences from the reference marker).

D-line The D-line (display line) is a horizontal line that can be positioned to mark and read out an arbitrary level in the test diagram.

| |
|--|
| Ref  |
|--|

The hotkey *Ref. R* switches the reference marker on or off (use the *ON/OFF* key).

The reference marker is represented by the symbol  in the test diagram. The marker position (abscissa) is defined in the input field *Ref. Marker R*. The marker can be positioned to arbitrary time values. It is switched off in the default setting (*Off*). The marker level is given by the measurement curve at the marker position.

The position of all markers can be varied using the rotary knob.

Remote control
No command, screen configuration only.

| |
|--|
| Rel  |
|--|

The *Rel. 1* hotkey switches the delta marker 1 on or off (use the *ON/OFF* key).

The delta marker 1 is represented by the symbol  in the test diagram. The marker position (abscissa) is defined in the input field *Rel. Marker 1*. The marker can be positioned to arbitrary time values. If its position is outside the diagram area it will be invisible and its coordinates will be "<abscissa_value> / - - -". The marker is switched off in the default setting (*Off*). The marker level is given by the measurement curve at the marker position.

The toggle switch *Rel 1 Config* pops up when the hotkey is pressed for the second time. It defines whether the position of delta marker 1 is measured and indicated in absolute units (dBm) or relative to the reference marker.

Remote control
No command, screen configuration only.

| |
|--|
| Rel  |
|--|

The *Rel. 2* hotkey switches the delta marker 2 on or off (use the *ON/OFF* key). Functions and remote control are analogous to delta marker 1.

| |
|---------------|
| D-Line |
|---------------|

The *D-Line* hotkey switches the D-line in the test diagram on or off.

The D-line is a horizontal, colored auxiliary line in the test diagram and is used for marking a level value and for measuring level differences. The level (ordinate) is determined in the input field *D-Line* and indicated on the D-line. The permissible value range is the diagram area, the default setting is Off.

The switch *D-Line Config* is opened by pressing *D-Line* twice and determines whether the D-line level is expressed in absolute units (in dBm, setting absolute) or relative to the RF Max. Level (in dB, setting relative).

Remote control

No command, screen configuration only.

**Display
Marker**

The *Display/Marker* softkey zooms or shifts the graphical display. It is selected by pressing the *Marker/Display* softkey twice. If pressed once again, the selected *Display/Marker* softkey changes back to the *Marker/Display* softkey, see above.

**Level
Scale**

The *Level Scale* hotkey defines the level range of the *Power* test diagram (ordinate scale). The scale can be adjusted in 0.1 dB steps. Note that, in contrast to the reference level, the range selection doesn't have any impact on the measurement.

The ordinate scale is calculated from the maximum level defined in the *Connection Control* menu (see section *Analyzer Settings* on page 4.73) and the range such that

- The *Max Level* defines the upper edge of the diagram.
- The difference *Max Level* – *Level Scale* defines the lower edge of the diagram.
- The number of horizontal grid lines (corresponding to 10, 15, or 16 cells) and the ordinate labeling is adapted to the range.

Remote control

[SENSe:]POWer:LEVel:RANGe <Range>

**Time
Scale Start**

The *Time Scale Start* hotkey defines the left edge of the *Power* test diagram (abscissa scale). The time scale of the diagram is derived from the *Time Scale Start* and the *Time Scale Span* assuming a constant number of 10 horizontal cells:

- *Time Scale Start* defines the left edge of the diagram.
- *Time Scale Start* + *Time Scale Span* defines the right edge of the diagram.
- The abscissa labeling is adapted to the defined time scale.

Time Scale Start is defined relative to the trigger time (delay). The permissible range of start times depends on the span (see below) and on the resolution bandwidth of the power measurement. As a general rule, larger values are allowed if the span is increased and the resolution bandwidth decreased.

Remote control

[SENSe:]POWer:TIME:DELaY <Delay>

**Time
Scale Span**

The *Time Scale Span* hotkey defines the time range of the *Power* test diagram (abscissa scale). The span is equal to the total measurement range of the *Power* measurement.

The time scale of the diagram is derived from the *Time Scale Start* and the *Time Scale Span* as explained above.

Remote control

[SENSe:]POWer:TIME:SPAN

Menus

The *Menus* softkey displays the hotkey bar for switching over to the other measurement menus.

Measurement Results

The values represented in the measurement menu *Power* can be divided into three groups:

- Setting values
- Scalar measurement results (marker values)
- The trace plotted as a function of time

These values are indicated in two parameter lines and the test diagram:

Parameter line 1/2

Test diagram with reference marker, delta marker 1 and 2 and D-line.

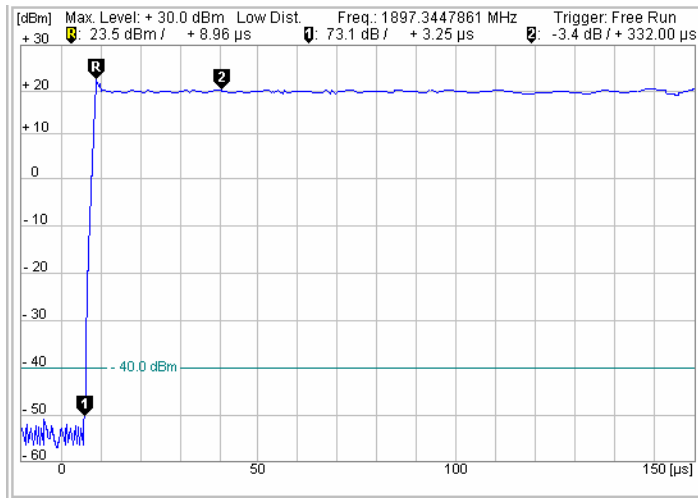

Fig. 4-23 Display of measurement results (Power menu)

Settings/ scalar measure- ment results

Settings and scalar measurement results are indicated in the two parameter lines above the test diagram

1st parameter line

The first parameter line contains the following settings:

| | |
|-----------------------|---|
| <i>RF Max. Level</i> | Maximum value of input level as set in the <i>Connection Control</i> menu (see section <i>Analyzer Settings</i> on page 4.73). |
| <i>RF Attenuation</i> | Setting for the attenuation of the input level (<i>Normal</i> , <i>Low Noise</i> , <i>Low Distortion</i>) as set in the <i>Connection Control</i> menu (see section <i>Analyzer Settings</i> on page 4.73). |
| <i>Freq.</i> | Center frequency of the RF signal analyzed |
| <i>Trigger</i> | Trigger mode (<i>Free Run</i> , <i>RF Power</i> , <i>IF Power</i> or <i>External</i>) |

2nd parameter line

The second parameter line contains the following marker values:

| | |
|----------|--|
| R | Level and time of reference marker |
| 1 | Level and time of delta marker 1 (setting <i>absolute</i>) or difference from reference marker (setting <i>relative</i>) |
| 2 | Level and time of delta marker 2 (setting <i>absolute</i>) or difference from reference marker (setting <i>relative</i>) |

Remote control

Settings are read out using the query corresponding to the setting command (setting command with appended question mark).
To obtain the measurement value at a single point on the trace the whole trace must be read, see below.

Measurement curves (arrays)

The measurement curve is displayed as a continuous trace in the test diagram together with the limit lines, markers and the D-line, if defined.

The measurement curve in the *Power* measurement menu shows the measured power of the received RF signal (in dBm) as a function of time (in μ s). The diagram scale, which is equal to the measurement range, and the displayed result depend on the test settings. The display mode for the measurement curve (*Minimum, Maximum, Average, Current*) is indicated in the upper right corner of the diagram.

Remote control

```
READ:ARRay:POWer[:RESult]...?
FETCh:ARRay:POWer[:RESult]...?
SAMPle:ARRay:POWer[:RESult]...?
```

Measurement Configurations (Power Configuration)

The popup menu *Power Configuration* determines the parameters of the power measurement. It is activated by pressing the softkey *Power* in the graphical measurement menu *Power* twice.

The *Power Configuration* menu controls the power measurement. It defines:

- The Repetition mode
- The type of measurement curve to be displayed (*Display Mode*)
- The *Statistic Count* for the measurement
- The center *Frequency* of the RF analyzer
- The *Resolution Bandwidth* of the measurement filter

Besides, it influences the power display by adding or removing the *Grid*.

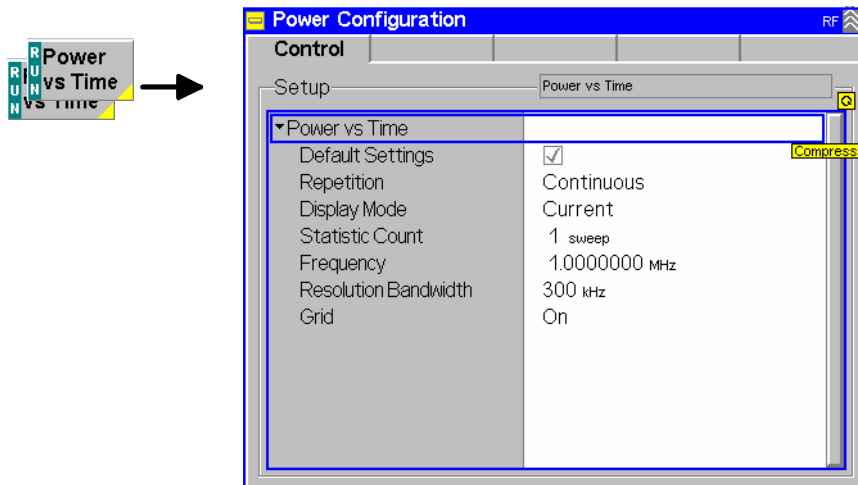

Fig. 4-24 Power Configuration – Control

Default Settings The *Default Settings* switch assigns default values to all settings in the *Control* tab (the default values are quoted in the command description in chapter 6 of this manual).

Remote Control

–

Repetition The *Repetition* field determines the repetition mode. The basic evaluation period (statistics cycle) corresponds to the evaluation of the trace over the entire time

range.

For more information see section *Analyzer/Generator Configuration* on p. 4.46 and section *General Settings* in Chapter 3.

Remote control

```
CONFigure:POWer:CONTRol:REPetition
    CONTInuous | SINGleshot | 1 ... 10000,NONE,<Stepmode>
```

Display Mode

The *Display Mode* field defines which of the four measured and calculated measurement curves is displayed. The measurement curves differ in the way the burst power $p(t)$ at a fixed point in time t is calculated if the measurement extends over several bursts:

| | |
|----------------|---------------------------------------|
| <i>Current</i> | Measured value for current burst |
| <i>Minimum</i> | Minimum over a number of bursts |
| <i>Maximum</i> | Maximum over a number of bursts |
| <i>Average</i> | Average value over a number of bursts |

The number of bursts for calculation of the statistical values *Minimum*, *Maximum* and *Average* – and thus the result – depends on the repetition mode set. In detail, this implies:

Single shot Display of minimum, maximum and average value from the performed statistics cycle.

Continuous Display of minimum and maximum from all bursts already measured. The **average value**, however, is calculated according to the rule in Chapter 3, section *General Settings*.

Remote control

no display mode set explicitly, the four measurement curves are accessible via

```
FETCh:ARRAy:POWer[:CURRent]? FETCh:ARRAy:POWer:MINimum?
FETCh:ARRAy:POWer:MAXimum? FETCh:ARRAy:POWer:AVERAge? etc.
```

Statistic Count

Statistic Count defines how many sweeps are combined to form one statistics cycle. Each sweep corresponds to the evaluation of the trace over the entire time range.

1 to 1000 sweeps Number of sweeps per statistics cycle

The settings *1* and *OFF* (press *ON/OFF* key) are equivalent. A statistics cycle determines the duration of single-shot measurements (see Chapter 3, section *General Settings*).

Remote control

```
CONFigure:POWer:CONTRol:STATistics 1 ... 1000 | NONE
```

Frequency

Frequency. defines the center input frequency for the measurement in MHz.

Remote control

```
[SENSe:]POWer:FREQuency:CENTer <Frequency>
```

**Resolution
Bandwidth**

Resolution Bandwidth defines the resolution bandwidth of the measurement filter. The nominal resolution bandwidth is the 3-dB bandwidth of the Gaussian measurement filter. From a list discrete bandwidths between 10 Hz and 1 MHz can be selected. The frequencies in the list are given by 1×10^n Hz, 2×10^n Hz, 3×10^n Hz, 5×10^n Hz where $n=1$ to 5. In addition the value 1 MHz can be selected.

Resolution bandwidths for the analyzer and the *Spectrum* measurement can be set independently (see also p. 4.56).

Remote control

```
[SENSe:]POWer:FREQuency:BANDwidth[:RESolution] <Bandwidth>  
[SENSe:]POWer:FREQuency:BWIDth[:RESolution] <Bandwidth>
```

Grid

The *Grid* checkbox switches The grid in the graphical test diagram on or off.

Remote control

—

Spectrum Measurement

The menu group *Spectrum* measures the signal power as a function of the frequency (spectrum analysis). The popup menu *Spectrum Configuration* is used for configuration of the measurements; the results (i.e. the spectrum) are displayed in the graphical measurement menu *Spectrum*.

Measurement Menu (Spectrum)

The graphical measurement menu *Spectrum* displays the results of the spectrum analysis (measurement of signal power as a function of the frequency).

- The main softkey *Spectrum* controls the measurement, indicates its status (*RUN* | *HLT* | *OFF*) and opens the configuration menu *Spectrum Configuration* (press twice). The hotkey associated with the main softkey defines the scope of the *Spectrum* measurement.
- The other softkeys to the right of the test diagram are combined with various hotkeys. If a softkey is selected and an associated hotkey pressed, a popup window will appear which indicates the current setting and enables an entry (see section [Measurement Menu \(Power\)](#) on page 4.49).

The measurement menu *Spectrum* is opened from the main menu *Menu Select* (with the associated key at the front of the instrument) or using the *Spectrum* hotkey.

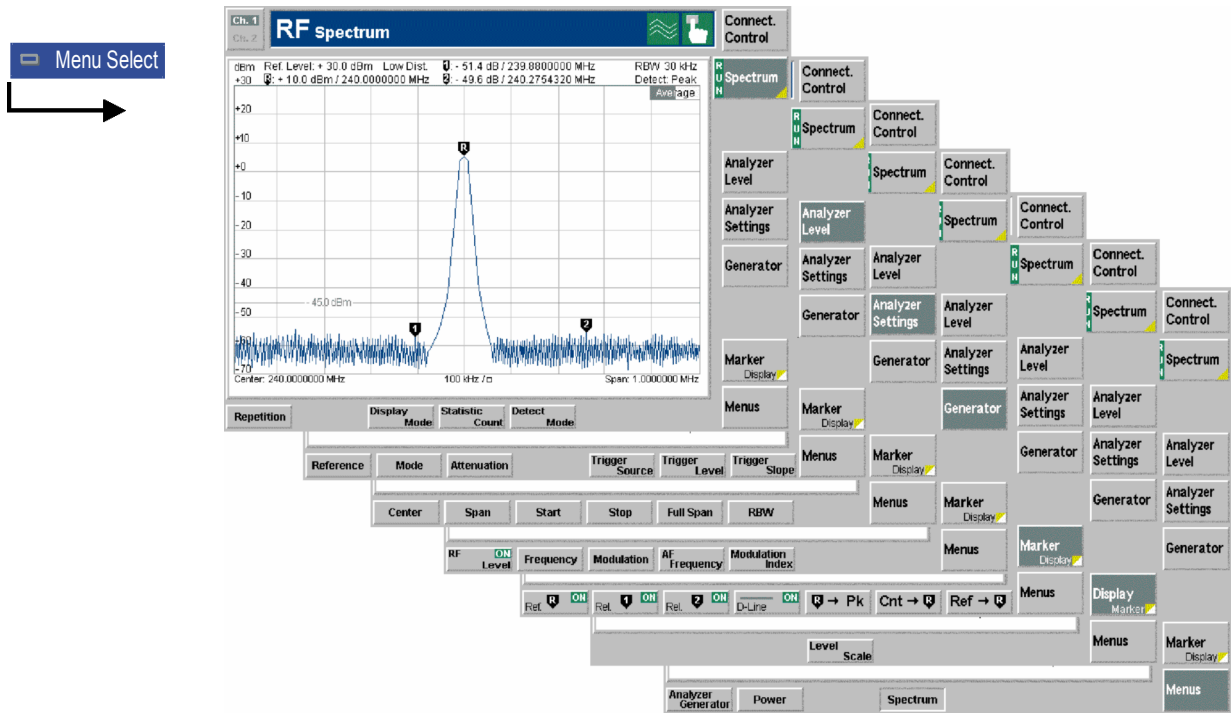

Fig. 4-25 Measurement menu Spectrum

Test settings

The basic settings for the *Spectrum* measurement are directly accessible from the measurement menu via softkey/hotkey combinations. The entry of values is described in section [Test Settings](#) on p. 4.43.

Some of the basic settings are also accessible from the *Spectrum Configuration* popup menu. They are explained in more detail in section [Measurement Configurations \(Spectrum Configuration\)](#) on page 4.64.

Spectrum

The *Spectrum* softkey controls the spectrum measurement and indicates its status (*RUN* | *HLT* | *OFF*). This status can be changed after softkey selection (pressing once) by means of the *ON/OFF* key or the *CONT/HALT* key.

Remote control

```
INITiate:SPECTrum; ABORt:SPECTrum
STOP:SPECTrum; CONTinue:SPECTrum
FETCh:SPECTrum:STATus?
```

Measurement configuration

Pressing the *Spectrum* softkey twice opens the popup menu *Spectrum Configuration* (see page 4.64). Besides, the measurement control softkey provides hotkeys to define the scope of the measurement. All these settings are described in more detail in section [Measurement Configurations \(Spectrum Configuration\)](#) on page 4.64.

Analyzer Level

The *Analyzer Level* softkey controls the level in the RF input signal path and provides the trigger settings for the current measurement.

The input level and trigger settings are general settings and therefore also provided in the *Connection Control* menu. They are described in more detail in sections [Analyzer Settings](#) on page 4.73 and [Trigger \(Connection Control – Trigger\)](#) on p. 4.92.

Reference Level

The *Reference Level* hotkey defines the reference level.

The reference level defines the upper edge of the diagram. It is generally different from the maximum input level set in the *Connection Control* menu, see section [Analyzer Settings](#) on page 4.73.

Remote control

```
[SENSe:]LEVel:REFerence <LEVel>
```

Analyzer Settings

The *Analyzer Settings* softkey determines the frequency range that is measured and displayed and the resolution bandwidth of the spectrum analyzer.

The settings are specific to the *Spectrum* menu. Some of them are also provided in the *Control* tab of the *Spectrum Configuration* menu; see section [Measurement Configurations \(Spectrum Configuration\)](#) on page 4.64.

A single measurement of the signal power over the whole frequency range (span, sweep width) by means of a spectrum analyzer is called a sweep. Typically, the minimum sweep time T_{\min} is linked to the resolution bandwidth B of the analyzer and the frequency range F by the relation $T_{\min} \sim F/B^2$. This means that a compromise between a high resolution, wide frequency range and high measurement speed must be reached.

The frequency range can be set in three different ways:

- By defining the center frequency f_c and the span Δf . The start and stop frequencies are thus given by $f_{\text{start}} = f_c - \Delta f/2$ and $f_{\text{stop}} = f_c + \Delta f/2$. This mode is convenient if the spectrum is to be analyzed in the vicinity of a known frequency which can be used as the center frequency of the diagram.
- By defining the start frequency f_{start} and the stop frequency f_{stop} . The center frequency and span are thus given by $f_c = (f_{\text{start}} + f_{\text{stop}})/2$ and $\Delta f = f_{\text{stop}} - f_{\text{start}}$.
- By selecting *Full Span* the default frequency range is displayed, i.e. the default start and stop frequencies are selected.

The number of vertical grid lines (i.e. the number of cells in horizontal direction) can be variable (depending on the frequency span) or fixed, see *Spectrum Configuration* menu on page 4.64.

Center

The *Center* hotkey defines the center frequency of the sweep range in MHz or in another frequency unit selected via the unit keys. The center frequency is identical with the *Frequency* set in the *Spectrum Configuration* menu.

Remote control

```
[SENSe:]SPEctrum:FREquency:CENTer <Frequency>
```

Span

The *Span* hotkey defines the sweep span.

Remote control

```
[SENSe:]SPEctrum:FREquency:SPAN <Frequency>
```

Start

The *Start* hotkey defines the start frequency of the sweep.

Remote control

```
[SENSe:]SPEctrum:FREquency:START <Frequency>
```

Stop

The *Stop* hotkey defines the stop frequency of the sweep.

Remote control

```
[SENSe:]SPEctrum:FREquency:STOP <Frequency>
```

Full Span

The *Full Span* hotkey sets the default sweep span.

On pressing the *Full Span* hotkey the abscissa of the spectrum diagram is changed, and the resolution bandwidth is set to *Auto*. However, the previous scaling parameters and resolution bandwidth are stored and the inscription of the *Full Span* hotkey changes to *Last Span*. The *Last Span* hotkey allows the previous scaling parameters and resolution bandwidth to be recalled and the previous diagram to be restored.

Remote control

Set *Start* and *Stop* to their default values. Resolution bandwidth see below.

RBW

The *RBW* hotkey defines the resolution bandwidth for the *Spectrum* measurement. The setting is also provided in the *Control* tab of the *Spectrum Configuration* menu; see section [Measurement Configurations \(Spectrum Configuration\)](#) on page 4.64.

Remote control

```
[SENSe:]SPEcTrum:FREQuency:BANDwidth[:RESolution] <Bandwidth>
[SENSe:]SPEcTrum:FREQuency:BWIDth[:RESolution] <Bandwidth>
```

| |
|---|
| Generator Tx Aux Tx |
|---|

The Generator softkey configures the RF signals generated. The generator settings are general settings and therefore also provided in the Connection Control menu. They are described in more detail in section

[Generator Settings \(Connection Control – Generator\)](#) on p. 4.76.

The RF Level hotkey is also used to switch the RF generator on and off.

If one of the options R&S CMU-B95 or R&S CMU-B96, *Second RF Generator*, is fitted, the *Generator* softkey toggles between the primary RF signal (*Tx*) and the auxiliary RF signal (*Aux Tx*) settings. The properties of the *Aux Tx* signal are also described in section

[Generator Settings \(Connection Control – Generator\)](#) on p. 4.76.

| |
|---------------------------------|
| Marker Display |
|---------------------------------|

The *Marker/Display* softkey positions up to 3 markers and a D-line in the test diagram and displays their values.

If pressed once again, the selected *Marker/Display* softkey changes to the *Display/Marker* softkey, see below.

Markers are graphical tools for marking points on the measurement curve and for numerical output of measured values. The measurement menu *Power* provides a reference marker and two further markers which permit to measure differences (delta marker 1 and 2).

The coordinates of the three markers are indicated in the format Ordinate value (level)/abscissa value (time) in a parameter line above the test diagram. The position of the reference marker is expressed in absolute units (level in dBm and time in bits), the delta marker by absolute or relative values (relative level in dB or time differences from the reference marker).

D-line The D-line (display line) is a horizontal line that can be positioned to mark and read out an arbitrary level in the test diagram.

| |
|---|
| Ref.  |
|---|

The hotkey *Ref. R* switches the reference marker on or off.

The reference marker is represented by the symbol  in the test diagram. The marker position (abscissa) is determined in the input field *Ref. Marker R*. The marker can be positioned to arbitrary frequency values. If its position is outside the diagram area it will be invisible and its coordinates will be “- - - / <abscissa_value>”. The marker is switched off by default. The marker level is given by the trace at the marker position.

The position of all markers can be varied using the rotary knob.

Remote control

```
FETCh:SPEcTrum:MARKer:ABSolute? <x position>
```

Rel. 1

The *Rel. 1* hotkey switches the delta marker 1 on or off.

The delta marker 1 is represented by the symbol  in the test diagram. The marker position (abscissa) is determined in the input field *Rel. Marker 1*. The marker can be positioned to arbitrary frequency values. If its position is outside the diagram area it will be invisible and its coordinates will be "- - - / <abscissa_value>". The marker is switched off by default. The marker level is given by the trace at the marker position.

The toggle switch *Delta Config.1* is opened by pressing *Rel. 1* twice and defines whether the second parameter line shows the absolute position of the delta marker (*absolute*, in dBm and time units) or its distance to the reference marker (*relative*, in dB and time units). If *absolute* is selected the inscription of the *Rel. 1* hotkey changes to *Abs. 1*.

Remote control

FETCh:SPECTrum:MARKer:RELative? <x1 position>, <x2 position>

Rel. 2

The *Rel. 2* hotkey switches the delta marker 2 on or off. Its functionality is analogous to delta marker 1.

D-Line

The *D-Line* hotkey switches the D-line in the test diagram on or off.

The D-line is a horizontal, colored auxiliary line in the test diagram and is used for marking a level value and for measuring level differences. The level (ordinate) is determined in the input field *D-Line* and indicated on the D-line. The permissible value range is the diagram area, the default setting is *Off*.

The switch *D-Line Config.* is opened by pressing *D-Line* twice and determines whether the D-line level is expressed in absolute units (in dBm, setting absolute) or relative to the RF Max. Level (in dB, setting relative).

Remote control

No command, only screen configuration



The hotkey *R to Pk* places the reference marker to the maximum of the trace.

Remote control

FETCh:SPECTrum:MARKer:PEAK?

Cnt → 

The hotkey *Cnt to R* centers the diagram to the frequency of the reference marker.

Ref → 

The hotkey *Ref to R* sets the reference level to the current marker position. It is recommended to use the three softkeys *R to Pk*, *Cnt to R* and *Ref to R* in succession to obtain a standard scale for the diagram.

Display
Marker

The *Display/Marker* softkey zooms or shifts the graphical display. It is selected by pressing the *Marker/Display* softkey twice. If pressed once again, the selected *Display/Marker* softkey changes back to the *Marker/Display* softkey, see above.

**Level
Scale**

The *Level Scale* hotkey defines the total level range of the *Spectrum* test diagram (ordinate scale). The ordinate scale is calculated from the *Reference* level (see above) and the *Level Scale* such that

- The *Reference* level defines the upper edge of the diagram.
- The difference *Reference* level – *Level Scale* defines the lower edge of the diagram.
- The number of horizontal grid lines (corresponding to 10, 15, or 16 cells) and the ordinate labeling is adapted to the range.

Remote control

[SENSe:]SPEctrum:LEVel:RANGe <Range>

Menus

The *Menus* softkey displays the hotkey bar for switching over to the other measurement menus.

Measurement Results

The values represented in the measurement menu *Spectrum* can be divided into three groups:

- Setting values
- Scalar measurement results (marker values)
- The trace plotted as a function of time

These values are indicated in two parameter lines and the test diagram:

Parameter line 1/2

Test diagram with reference marker, delta marker 1 and 2 and D-line.

Abscissa labels

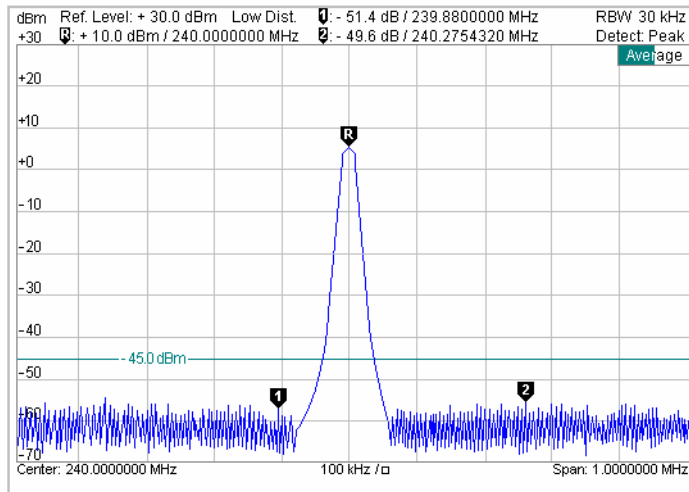

Fig. 4-26 Display of measurement results (Spectrum menu)

Settings/ scalar measure- ment results

Settings and scalar measurement results are indicated in the two parameter lines above the test diagram

1st parameter line

The first parameter line contains the following settings:

- Ref. Level** Reference level; upper edge of the diagram as set with the *Analyzer Level – Ref. Level* hotkey
- 1** Level and time of delta marker 1 (setting *absolute*) or difference from reference marker (setting *relative*)
- RBW** Resolution bandwidth (*Auto* or numeric value)

2nd parameter line

The second parameter line contains the following marker values:

- R** Level and time of reference marker
- 2** Level and time of delta marker 2 (setting *absolute*) or difference from reference marker (setting *relative*)

Remote control

Settings are read out using the query corresponding to the setting command (setting command with appended question mark).

To obtain the measurement value at a single point on the trace the whole trace must be read, see below.

Measurement curves (arrays)

The continuous curve in the test diagram shows the measured power (in dBm) as a function of the frequency (in MHz). The curve depends on the display mode (*Current, Max./Min., Average*) that can be set in the configuration menu (see section [Measurement Configurations \(Spectrum Configuration\)](#) on page 4.64). The display mode is indicated in the upper right corner of the diagram.

The measurement curve extends over the frequency range (*Span*) indicated below the diagram and is interpolated from 560 points, each corresponding to one pixel of the CMU's LC display. The number of measurement values is actually larger than 560; the coordinates of the pixels defining the curve can be calculated according to the peak or RMS *Detect Mode* described in section [Measurement Configurations \(Spectrum Configuration\)](#) on page 4.64.

Remote control

```
READ:ARRay:SPEctrum[:RESult][:CURRent]?
FETCh:ARRay:SPEctrum[:RESult][:CURRent]?
SAMPle:ARRay:SPEctrum[:RESult][:CURRent]?
READ:SUBarrays:SPEctrum[:RESult][:CURRent]?
READ:SUBarrays:SPEctrum[:RESult]:AVERage? etc.
```

Measurement Configurations (Spectrum Configuration)

The popup menu *Spectrum Configuration* determines statistical and display parameters for the spectrum analysis. It is activated by pressing the softkey *Spectrum* in the graphical measurement menu *Spectrum* twice. In the *Control* tab, the configuration menu defines:

- The repetition mode (*Repetition*)
- The type of measurement curve to be displayed (*Display Mode*)
- The number of sweeps forming a statistics cycle (*Statistic Count*)
- The format of the grid (*Scaling Mode*)
- The prescription for calculating the curve from the entire set of measurement points (*Detect Mode*)
- The center *Frequency* of the spectrum measurement
- The *Resolution Bandwidth* of the measurement filter

Besides, it influences the spectrum display by adding or removing a *Grid* with configurable cells.

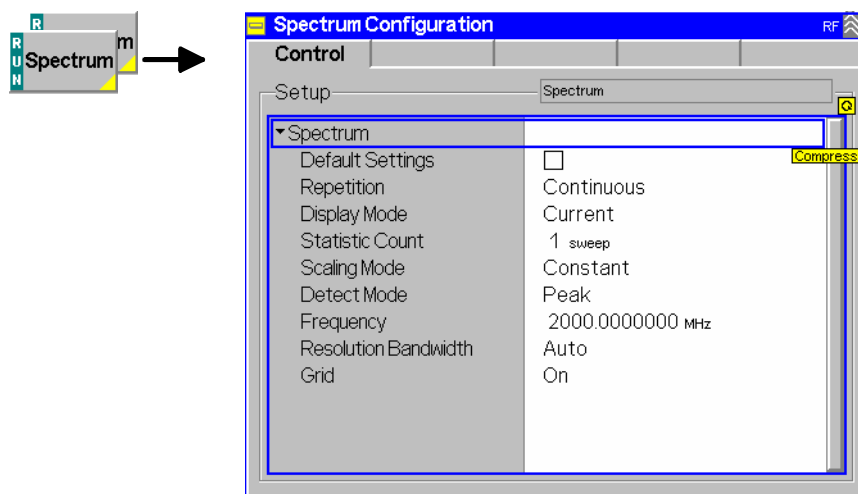

Fig. 4-27 Spectrum Configuration – Control

Many functions of this menu comply with those of the *Control* tab of the *Power Configuration* menu (see page 4.53). In the remote-control commands, the keyword `POWER` is to be replaced by `SPECTrum`.

Default Settings The *Default* switch assigns default values to all settings in the *Control* tab (the default values are quoted in the command description in chapter 6 of this manual).

Remote Control

–

Repetition *Repetition* determines the repetition mode, see chapter 3 and explanations given on page 4.53 for the *Power* measurement.

Remote control

```
CONFigure:SPECTrum:CONTRol:REPetition
CONTinuous | SINGleshot | 1 ... 10000,NONE,<Stepmode>
```

Display Mode *Display Mode* defines which of the four measured and calculated measurement curves is displayed. The measurement curves differ in the way the RF signal power $p(t)$ at a fixed point in time t is calculated if the measurement is repeated several times:

Current Measured value for current sweep

Minimum Minimum over a number of sweeps

Maximum Maximum over a number of sweeps

Average Average value over a number of sweeps

One sweep corresponds to the evaluation of the trace over the whole measurement range. The number of sweeps for calculation of the statistical values *Minimum*, *Maximum* and *Average* – and thus the result – depends on the repetition mode set (see page 4.53). In detail, this implies:

Single shot Display of minimum, maximum and average value from the performed statistics cycle (see *Statistic Count* definition below).

Continuous Display of minimum and maximum from all sweeps already measured. The **average value**, however, is calculated according to the prescription in Chapter 3, section *General Settings*.

Remote control

no display mode set explicitly, the four measurement curves are accessible via

```
FETCH:SUBarrays:SPECTrum[:CURRent]?
FETCH:SUBarrays:SPECTrum:MINimum?
FETCH:SUBarrays:SPECTrum:MAXimum?
FETCH:SUBarrays:SPECTrum:AVERage? etc.
```

Statistic Count *Statistic Count* defines how many sweeps are combined to form one statistics cycle.
1 to 1000 sweeps Number of sweeps per statistics cycle

The settings 1 and OFF (press ON/OFF key) are equivalent. A statistics cycle determines the duration of single-shot measurements (see Chapter 3, section *General Settings*).

Remote control

```
CONFigure:POWer:CONTRol <MODE>,1 ... 1000 | NONE
```

Grid / Scaling Mode *Grid* switches on or off the grid in the graphical test diagram. In addition the *Scaling Mode*, i.e. the number of grid cells in horizontal direction (frequency axis) can be selected:

Variable The number of horizontal grid cells is adapted to the sweep span of the *Spectrum* measurement, see page 4.59.

Constant The diagram consists of a constant number of 10 horizontal grid cells.

Remote control

DISPlay:SPECTrum:CONTrol:GRID ON | OFF

Detect Mode *Detect Mode* defines how the measurement curve is calculated from the entire set of measurement points. The curve is interpolated from 560 points, each corresponding to one pixel of the CMU's LC display. The number of measurement values is actually larger than 560; the coordinates of the pixels defining the curve can be calculated in two alternative ways:

Peak The y-coordinate (power) of each pixel is equal to the maximum of all measurement values falling inside the pixel range.

RMS The y-coordinate of each pixel is equal to the RMS average of all measurement values falling inside the pixel range.

The two settings yield different curves, especially in domains where the signal shows strong power variations (e.g. in the noise floor around a distinct spectral lobe). RMS averaging tends to smooth out the spectral curve and to suppress the noise. On the other hand, very narrow peaks may be underestimated if RMS *Detect Mode* is set.

Remote control

[SENSe:]SPECTrum:DETEctor PEAK | RMS

Frequency *Frequency* defines the center frequency of the measurement range in MHz or in another frequency unit selected via the unit keys. The center frequency is identical with the *Center* frequency set with the *Analyzer Settings* softkey.

Remote control

[SENSe:]SPECTrum:FREQuency:CENTer <Frequency>

Resolution Bandwidth *Resolution Bandwidth* defines the resolution bandwidth for the *Spectrum* measurement. The resolution bandwidth is identical with the *RBW* set with the *Analyzer Settings* softkey.

The nominal resolution bandwidth is the 3-dB bandwidth of the measurement filter. From a list discrete bandwidths between 10 Hz and 1 MHz can be selected. The frequencies in the list are given by 1×10^n Hz, 2×10^n Hz, 3×10^n Hz, 5×10^n Hz where $n=1$ to 5. In addition the two values 1 MHz and *Auto* can be selected.

With the *Auto* setting the resolution bandwidth is automatically adapted to

$$\text{bandwidth} = \text{span}/50$$

(if this value is inside the allowed range).

Resolution bandwidths for the analyzer and the *Power* measurement can be set independently (see also p. 4.49).

Remote control

[SENSe:]SPECTrum:FREQuency:BANDwidth[:RESolution] <Bandwidth>
[SENSe:]SPECTrum:FREQuency:BWIDth[:RESolution] <Bandwidth>

I/Q vs. Slot Measurement

The *I/Q vs. Slot* measurement provides averaged *I/Q* amplitudes in a sequence of consecutive measurement steps of configurable length.

Typically, *I/Q vs. Step* is used to measure the *I/Q* amplitudes over a series of power steps, e.g. in order to assess the nonlinearities of a mobile phone's modulator. With a signal of the shape shown below (see Figure 4-1, example 1), the measurement is most conveniently triggered using a power trigger. The measurement starts after a specified *Trigger Delay*. Measurement data is acquired continuously, however, the *I/Q* amplitudes for each measurement step are only averaged over an area with a configurable *Measurement Length*. Note that the measurement can be performed as well if the first power step is longer than the following ones or if an external trigger signal is used (examples 2 and 3).

Example 1: Power trigger, all steps including the first one are equidistant

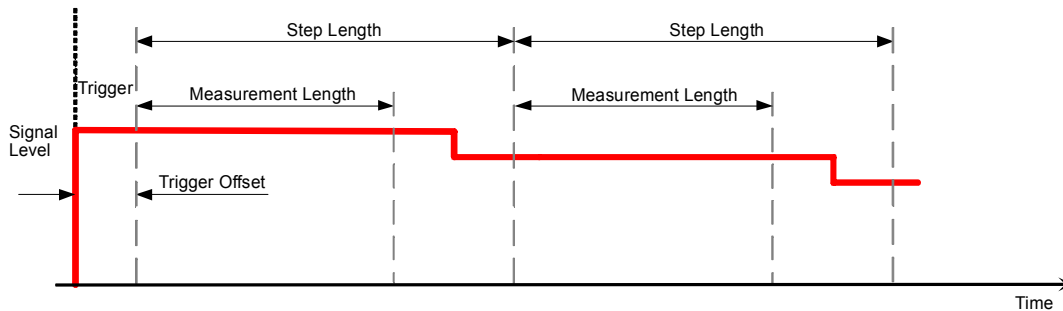

Example 2: Power trigger, first step is longer than the others

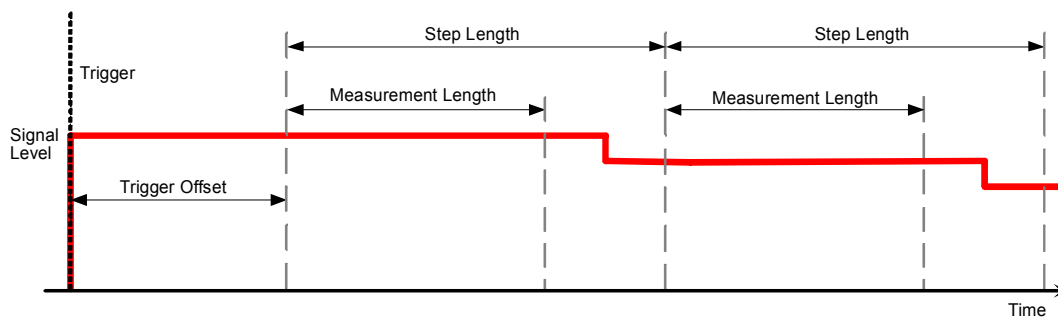

Example 3: External trigger occurs before the first step

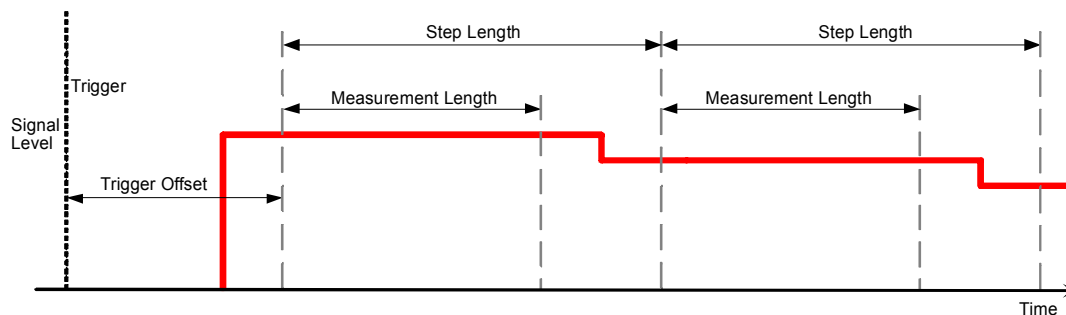

Figure 4-1 Step Length, Measurement Length and Trigger Offset

To compensate for a constant frequency offset of the measured signal, the frequency is estimated in all measurement areas $i = 1, \dots, \langle \text{Number of Steps} \rangle$, which yields a set of individual frequency offset values $\Delta\omega_i$. The $\Delta\omega_i$ for measurement areas with a signal level below a specified *Frequency Estimation Limit* are discarded; the remaining $\Delta\omega_i$ are used to calculate a common, weighted average frequency offset $\Delta\omega_{\text{avg}}$. This average value corrects the signal frequency in all measurement areas, including the

ones below the *Frequency Estimation Limit*. The average frequency error $\Delta\omega_{avg}$ (*Freq. Err.*) is also displayed in the upper right corner of the measurement menu.

The phase in the first measurement step is arbitrarily set to zero.

The *I/Q vs. Slot* measurement can be configured using the hotkeys associated with the *I/Q vs. Slot* measurement control softkey. Alternatively the settings are accessible from the *I/Q vs. Slot Configuration* menu.

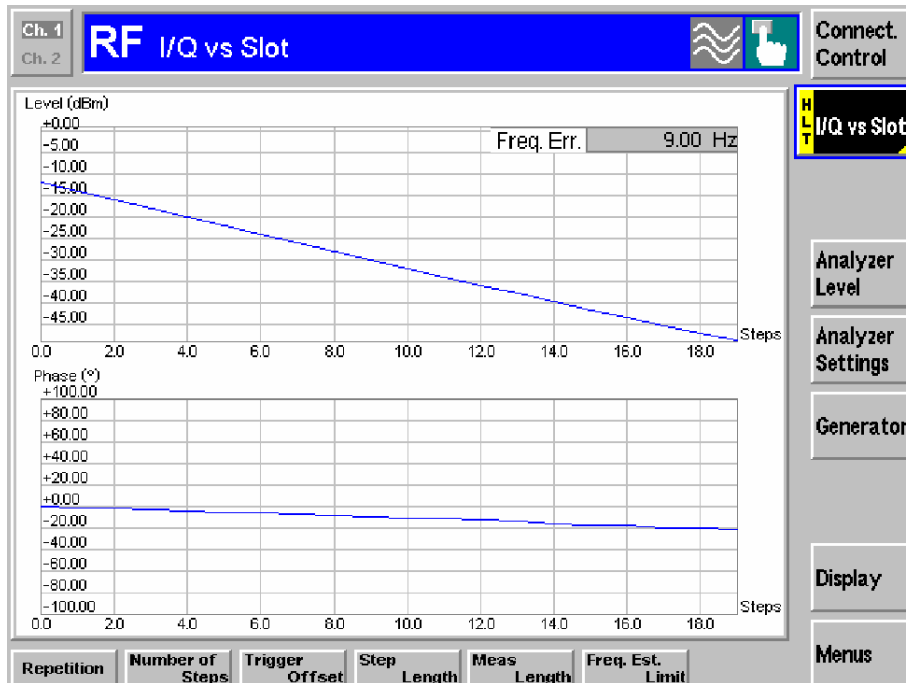

Figure 4-1 I/Q vs. Slot measurement menu

Number of Steps

Number of Steps defines the number of measured steps, which is equal to the number of averaged I/Q amplitude results that the R&S CMU acquires in each subsweep (see section *I/Q vs. Slot Multiple Sub sweep Measurements* on p. 4.69).

The total number of steps per measurement cycle must not exceed 100, i.e.:

$$Number_{Steps} * Number_{Subsweeps} \leq 1000.$$

Furthermore, the following condition applies:

$$Number_{Subsweeps} * \{(Number_{Steps}-1) * Length_{Step} + Length_{Measurement}\} \leq Length_{Max. Capture}$$

where

*Length_{Step}, Length_{Measurement} and Length_{Max. Capture} are in μs , and
Length_{Max. Capture} is 524288 μs , if option CMU-U65v04 is installed.*

The maximum capture length depends on the installed hardware, an overview is given in the table below.

Example: A $Length_{Step}$ of 667 μs results in a max. $Length_{Measurement}$ of 617 μs . With the max. allowed number of subsweeps of 20, the resulting steps are

$$Number_{Steps} \leq \{[(524288 \mu s / 20) - 617 \mu s] / 667 \mu s\} + 1$$

$$Number_{Steps} \leq 39.377$$

Therefore there may be a maximum of 39 steps in a subsweep, otherwise the performance of the measurement may suffer.

Remote control
 CONFigure:IQSLot:CONTRol:NOSTeps

Table 4-1 I/Q vs. Slot parameters for different versions of option R&S CMU-U65

| Parameter | R&S CMU-U65v02, DDC200 | R&S CMU-U65v02, DDC400 | R&S CMU-U65v04, WDDC400 |
|---|---------------------------|---------------------------|---------------------------------------|
| Max. Capture Length / μ s | 32 768 | 131 072 | 52 4288 |
| Max. no. of subsweeps | 1 | 1 | 20 |
| Max. no. of steps (step length 667 μ s, meas. length 617 μ s) | 49 | 196 | 39 (20 subsweeps) 786 (1 subsweep) |
| Max. no. of steps (step length 1500 μ s, meas. length 1450 μ s) | 21 | 87 | 17 (20 subsweeps) 349 (1 subsweep) |

I/Q vs. Slot Multiple Subsweep Measurements

The I/Q vs. Slot measurement above shows a single-sweep measurement. Additionally, a multiple subsweep measurement feature allows to capture up to 20 multiple subsweeps. This is accomplished as shown in Figure 4-2 below.

After each subsweep the trigger is rearmed. The minimum time between the end of a subsweep and the next trigger event should be at least **100 μ s**.



This feature works only with the installed option CMU-U65v04.

Single sweep:

Input signal and resulting output signal power

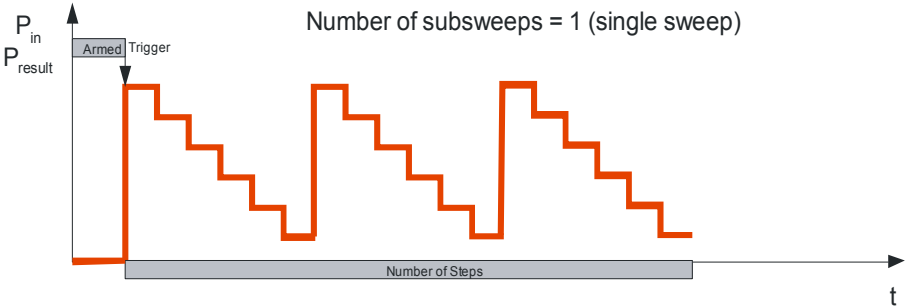

Multiple Sweep:

Input signal

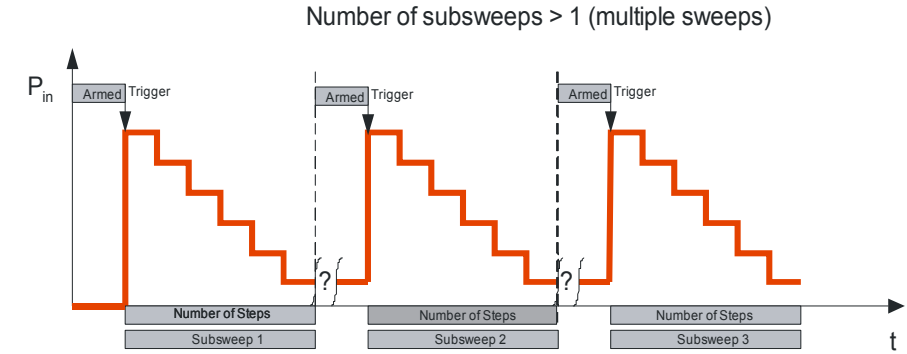

Displayed result (output signal power)

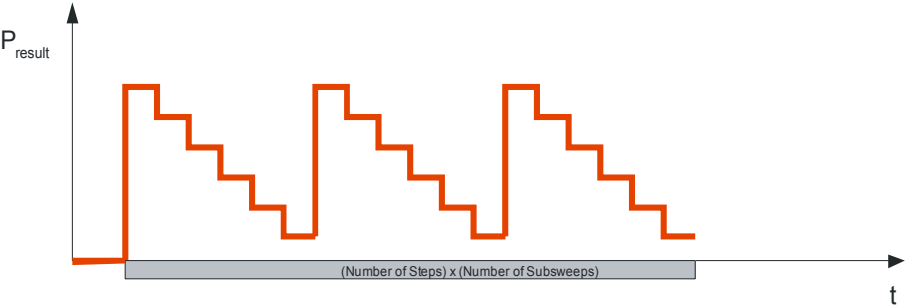

Figure 4-2: Input and output of single sweep and multiple sweep mode measurements

The *I/Q vs. Slot* multiple subsweep measurement can be configured using the *Number of Steps* hotkey associated with the *I/Q vs. Slot* measurement control softkey.

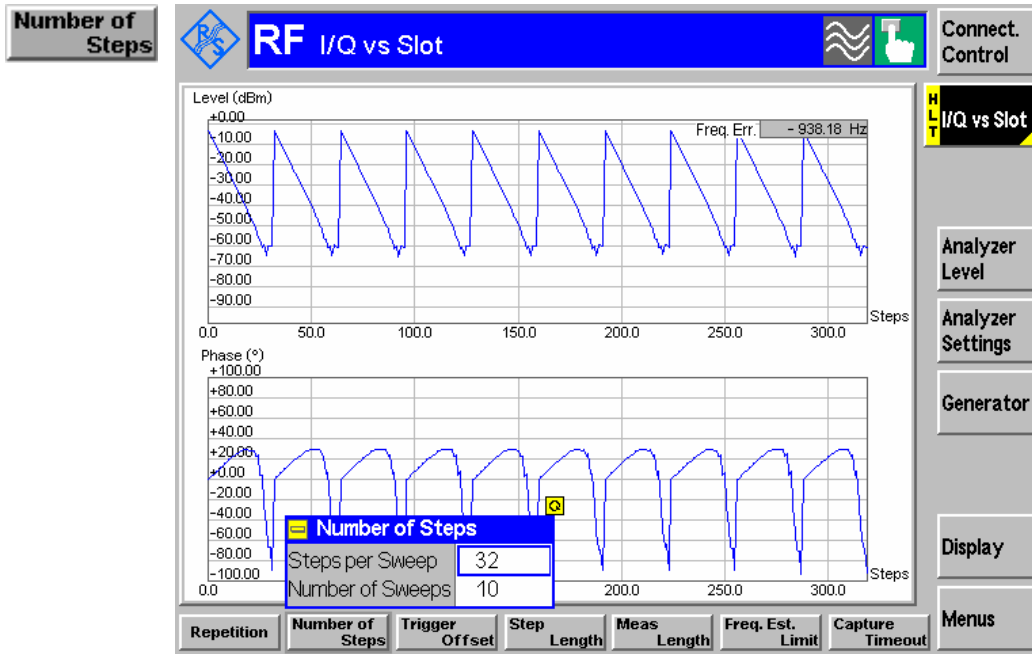

Figure 4-3 I/Q vs. Slot Number of Sweeps selection

Alternatively, the Number of Subsweeps can be defined in the popup menu *I/Q vs Slot Configuration*, which is activated by pressing the measurement control softkey at the top right in the graphical measurement menu *I/Q vs Slot* twice.

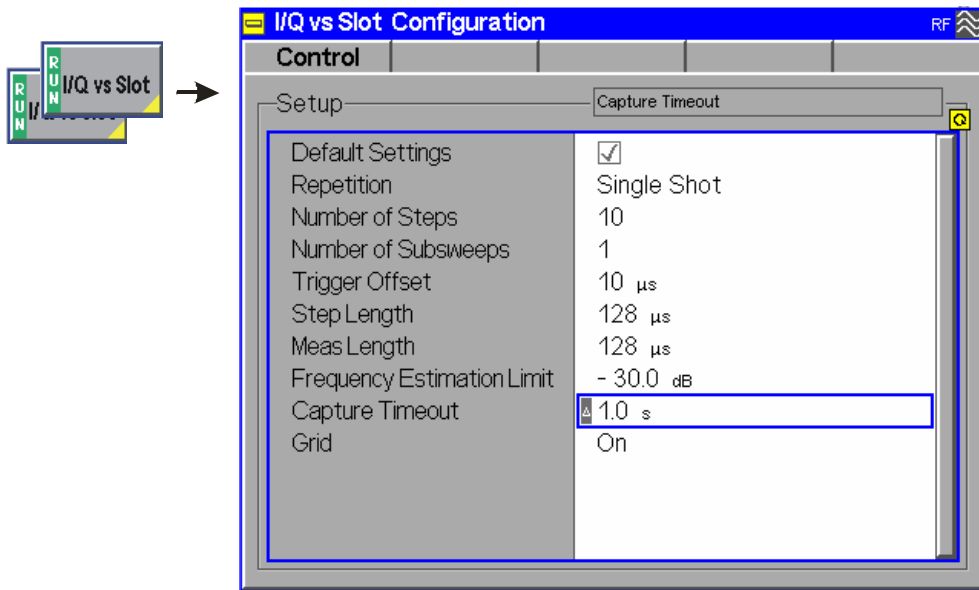

Figure 4-2 I/Q vs Slot Configuration – Control

Number of Subsweps

The *Number of Subsweps* defines whether a single sweep (value = 1) or a multiple sweep (value > 1) measurement is performed. Multiple sweep measurements are performed as shown in Figure 4-2 and Figure 4-3.

After each subsweep, the trigger is rearmed. The trigger system needs a minimum time of 100 µs between the end of a subsweep and the next trigger event.

For performance reasons, the maximum number of subsweeps is limited to 20. In addition, the total number of measurement steps per measurement cycle is limited, depending on the hardware equipment of the R&S CMU200, see section *I/Q vs. Slot Measurement* on p. 4.66, description of *Number of Steps* parameter.

Remote control

```
CONFigure:IQSLot:CONTRol:NOSubsweeps
```

Capture Timeout
or

The capture timeout value defines the maximum time interval the R&S CMU will wait for the capturing of new input signals after having armed the trigger. This is applied for every subsweep. If the time has elapsed, the application displays an error message.

Remote control

```
CONFigure:IQSLot:CONTRol:CTIMEout
```

Connection Control

The popup menu *Connection Control* contains several tabs to configure the inputs and outputs of the R&S® CMU and the respective signals in the *RF* function group and the trigger settings.

The menu group is activated via the softkey *Connect. Control* to the right of the header of each measurement menu. The individual tabs (*Analyzer, Generator, RF* \leftrightarrow , *Sync., Trigger, I/Q-IF*) can be accessed via the hotkey bar at the lower edge of the screen.

Analyzer Settings (Connection Control – Analyzer)

The *Analyzer* tab adjusts the RF input path to the expected input power (*RF Max. Level*) and sets the center frequency of the RF analyzer. The CMU provides a softkey-oriented version of the *Analyzer* tab and a table-oriented version with extended functionality. The *Analyzer* hotkey toggles between the two versions if it is pressed repeatedly.

Softkey-Oriented Version

The softkey-oriented version of the *Analyzer* tab determines the maximum input level (*RF Max. Level*), the way this level is defined (*RF Mode*) and the attenuation of the RF input path (*RF Atten.*). All settings of this menu are also provided in the table-oriented version of the *Analyzer* tab; see section *Table-Oriented Version* on p. 4.73.

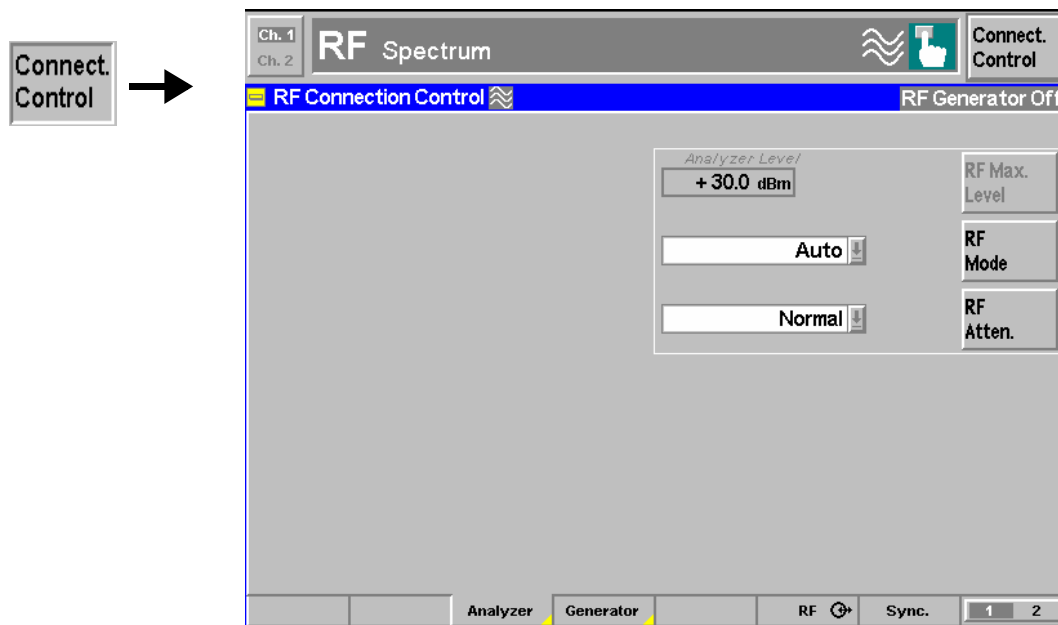

Fig. 4-28 Connection Control – RF analyzer settings (softkey)

Table-Oriented Version

The table-oriented version of the *Analyzer* tab determines:

- The maximum expected input level (*RF Max. Level*) and the way it is defined (*RF Mode*)
- An external input attenuation or gain (*RF Attenuation*)
- The Frequency and the resolution Bandwidth of the RF analyzer (*Analyzer Settings*)
- The RF Path for the analyzed signal

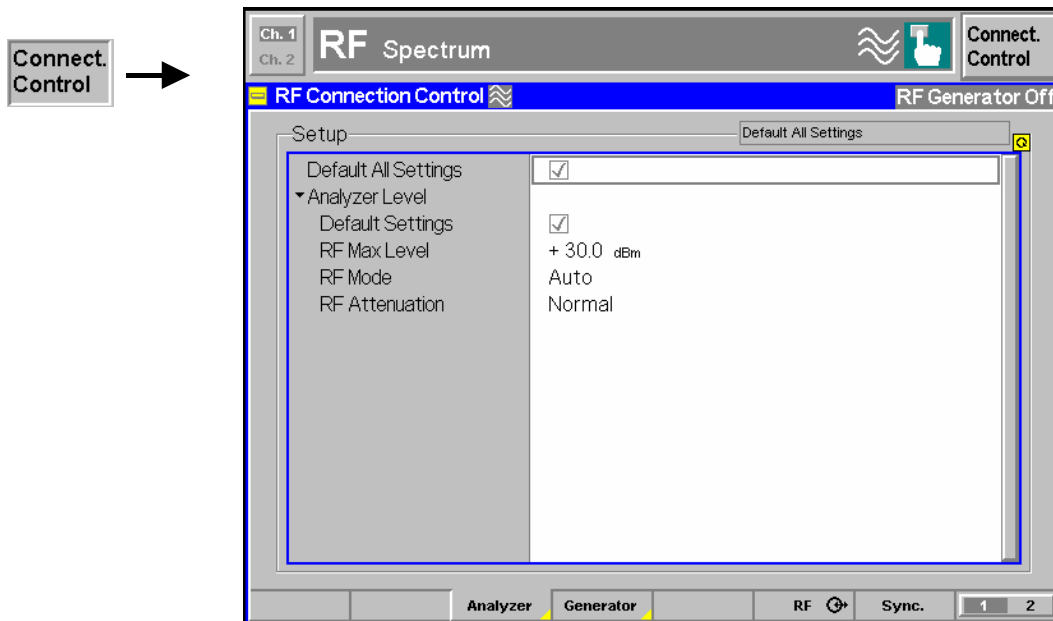

Fig. 4-29 Connection Control – RF analyzer settings (table)

Default Settings *Default All Settings* assigns default values to all settings in the *Analyzer* tab (the default values are quoted in the command description in chapter 6 of this manual). Additional default switches are provided for the *Analyzer Level* and *Analyzer Settings* table sections.

Remote Control
`[SENSe:]LEVel:DEFault`

RF Max. Level *RF Max. Level* determines the maximum permissible input level (overload level). The maximum input level determines the upper edge of the diagram in the graphical menu *Power* and is also displayed next to the softkey *RF Max. Level* in the main menu *Analyzer/Generator* (see page 4.41). The upper edge of the *Spectrum* diagram is set independently via the *Reference* hotkey.

RF Mode *RF Mode* determines how the maximum input level is set:

| | |
|---------------|--|
| <i>Manual</i> | Manual input of maximum input level |
| <i>Auto</i> | Automatic setting of maximum input level (autoranging) according to the power of the applied signal. |

Remote control
`[SENSe:]LEVel:MODE MANual | AUTomatic`

The value range depends on the selected RF input (see section [Generator Settings \(Connection Control – Generator\)](#) on page 4.76):

External attenuation If an external input attenuation is reported to the instrument (see section [RF Connectors \(Connection Control – RF\)](#) on page 4.84), all levels measured are referenced to the output of the DUT and therefore shifted with respect to the actual level at the input connectors of the CMU. The level ranges for the input connectors are shifted as well.

Input levels exceeding the *RF Max. Level* can not be measured; the corresponding measurement result fields indicate invalid results “--”.

Error messages If the value determined for *RF Max. Level* is too high or too low, a window with the error message “<Max_Level> is out of range. <permissible max. value> is limit.” and three fields will appear:

Accept The permissible max. value is accepted as RF Max. Level

Re-edit RF Max. Level is entered once again

Cancel The last valid input value is maintained

When switching over to another input, the current value of *RF Max. Level* is automatically adapted, if required:

- Towards lower values to the maximum permissible value of the new input,
- Towards upper values to the minimum value of the new input.

Note: *A maximum input level can be entered even if automatic level setting (autoranging) is selected. The entered level is used as a start value for the autoranging routine and is also important to ensure safe switchover to manual setting.*

Remote control

[SENSe:]LEVel:MAXimum <Level>

RF Attenuation *RF Attenuation* defines how the RF analyzer of the CMU is tuned to meet the requirements of the current measurement type. In general, a compromise between the acceptable noise level in the displayed result and the contribution of internally generated distortion must be reached.

Normal Mixer level in normal range

Low noise Mixer level enhanced by +10 dB (full dynamic range of CMU, therefore recommended for both *Power* and *Spectrum* measurements)

Low distortion Mixer level reduced by –10 dB (high intermodulation spacing)

The *RF Attenuation* setting permits the CMU to be adapted to the requirements of the measurement. The advantages and disadvantages of the settings *Low noise* and *Low distortion* are listed in the following table.

| | Advantages | Disadvantages |
|-----------------------|---------------------------------|--|
| Low noise | Low noise high dynamic range | No RF overdrive reserve Risk of intermodulation |
| Low distortion | High intermodulation spacing | Lower dynamic range |

Remote control

[SENSe:]LEVel:ATTenuation NORMAL | LNoise | LDISTortion

Generator Settings (Connection Control – Generator)

The *Generator* tab configures the RF generator, in particular by defining the output level (*RF Level*), the *Frequency*, *Modulation* and *Frequency Hopping*. The R&S® CMU provides a softkey-oriented version of the *Generator* tab and a table-oriented version with extended functionality. The *Generator* hotkey toggles between the two versions if it is pressed repeatedly.

Softkey-Oriented Version

The *Generator* tab controls and configures the RF generator. In addition to its primary RF signal (*Tx* signal), the CMU provides an independent RF signal *Aux Tx* (with one of the options R&S CMU-B95 or R&S CMU-B96, *Additional RF Generator*), which can be configured as follows:

- Level and frequency settings (*RF Level*, *Frequency*, *Frequency Offset*)
- Selection of an amplitude *Modulation* (including *AF/SSB Frequency*, *Modulation Index*)

All settings of this menu are also provided in the softkey-oriented version of the *Generator* tab; see section [Table Oriented Version](#) on p. 4.77.

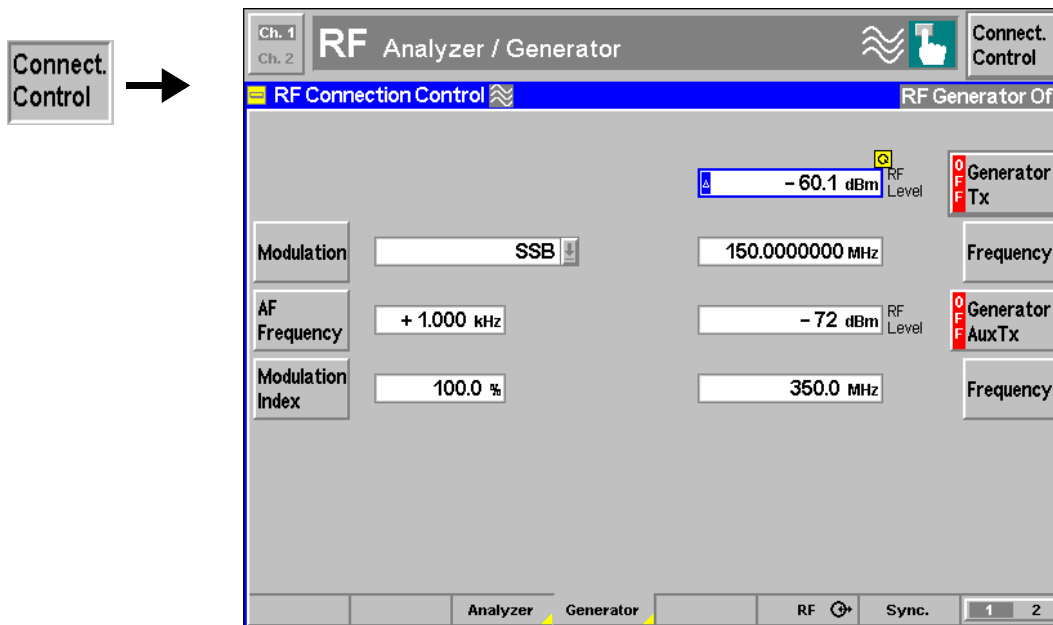

Fig. 4-30 Connection Control – RF generator settings (softkey)

Table Oriented Version

The table-oriented version of the *Generator* tab configures the independent RF output signals Tx and Aux Tx. It defines:

- *Level, Frequency, Frequency Offset and Modulation*
- Switchover between two frequencies (*Frequency Hopping*, for Tx signal only)
- Time dependence of the signal power (*Ramping*, for Tx signal only)
- Reduction of the phase noise (*Low Spur Mode*)

Aux Tx signal:

If option CMU-B95, *Additional RF Generator*, is fitted, the CMU provides a second RF signal AuxTx that can be applied to one of the RF connectors RF1 or RF2. It is possible to superimpose both RF signals at the same output connector or use different connectors (see section *RF Connectors (Connection Control – RF)* on p. 4.84). Moreover, it is possible to assign independent external attenuation factors to both signals.

With option CMU-B96, *Additional RF Generator*, the CMU provides three additional AuxTx signals:

- Two low-level signals Path 1 and Path 2 can be configured with different frequencies and levels. When it is switched on the AuxTx generator activates one of the preconfigured low-level signals.
- An additional *Overrange* signal at the frequency of the active low-level AuxTx signal but with possibly higher level can be generated together with the low-level signal. If it not needed, this signal can be switched off.

Again it is possible to superimpose AuxTx and Tx signals and to assign independent external attenuation factors.

AuxTx is generated with the modulation settings of the primary Tx signal (in remote control: ...RFGenerator:MODulation...) but with no frequency hopping or ramping. Options R&S CMU-B95/B96 extend the functionality of the GSM-MS and WCDMA UE measurements, see operating manuals for options R&S CMU-K20/.../K24 and for options R&S CMU-K61/.../K69.

Note: *The Aux Tx signals are not compatible with FM modulation. The Aux Tx generator is switched off when the modulation mode is set to FM. It remains in the Off state even when FM modulation is deactivated.*

Options R&S CMU-B95 and R&S CMU-B96 are available for R&S CMU200 instruments only.

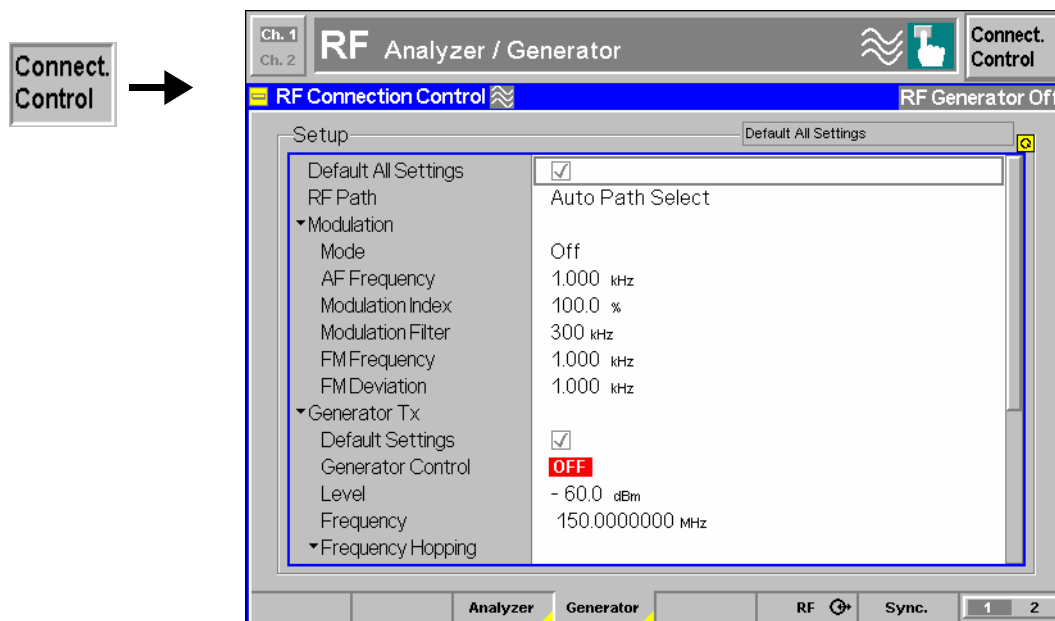

Fig. 4-31 Connection Control – RF generator settings (table)

Default Settings *Default All Settings* assigns default values to all settings in the *Generator* tab (the default values are quoted in the command description in chapter 6 of this manual). Additional default switches are provided for the individual signals *Tx* and *Aux Tx*.

```
Remote Control
DEFAult:RFGenerator
DEFAult:RFGenerator:TX
DEFAult:RFGenerator:AUXTx
```

The following modulation settings are valid for both the *Tx* and the *Aux Tx* signal.

Modulation – Mode *Modulation – Mode* selects the modulation scheme of the RF signal.

Off Unmodulated (CW) RF carrier signal

SSB RF carrier is shifted by a constant AF offset frequency defined with the *AF Frequency* softkey (Single Side Band modulation).

AM RF carrier is amplitude-modulated by means of AF signal with constant frequency and modulation index set with the *AF Frequency* and *Modulation Index* softkeys.

FM RF carrier is frequency-modulated with the frequency and deviation set with the *FM Frequency* and *FM Deviation* softkeys. FM modulation is incompatible with the *Aux Tx* signal; see background information above.

FM Stereo FM stereo transmitter mode, to be configured in the *FM Stereo* section. The FM stereo transmitter requires option R&S CMU-K14 and is described in section *Options and Extensions – FM Stereo Transmitter* at the end of this chapter.

Note: The AM setting shifts the level ranges of all three RF outputs by – 6 dB. Generating a FM modulated signal which is accurate over the full *FM Frequency* and *FM Deviation* parameter range requires an FM Modulation Calibration; see description of the Maintenance menu. It is sufficient to perform the calibration once after installing the RF software; the CMU will store the calibration data.

```
Remote control
SOURce:RFGenerator:MODulation OFF | SSB | AM | FM | FMST
```

AF Frequency *AF Frequency* defines an AF frequency which is used for SSB or AM modulation; see *Modulation* softkey above.

If SSB modulation is set, the frequency of the RF carrier signal is shifted by the AF frequency, which can be either positive or negative. If AM modulation is set, the RF signal is amplitude-modulated with the AF frequency (which has to be positive) and with a given modulation index (see softkey *Modulation Index* below). An application for SSB modulation is given in chapter 7.

```
Remote control
SOURce:RFGenerator:MODulation:SSB:FREquency <Frequency>
```

Modulation Index *Modulation Index* defines the modulation index for AM modulation, i.e. the amplitude ratio of the modulating AM signal to the RF carrier signal in percent.

The modulation index is in the range of 0% (no amplitude modulation) to 100%. Overmodulation is excluded.

Remote control

SOURce:RFGenerator:MODulation:AM:INDEX <Mod_Index>

Modulation Filter *Modulation Filter* defines the resolution bandwidth of the modulation filter. The bandwidths 30 kHz, 300 kHz or *Off* (corresponding to a broadband modulation filter) can be selected.

In a *Spectrum* measurement a modulation filter suppresses the signals located to the right and to the left of the center frequency.

Remote control

SOURce:RFGenerator:BANDwidth[:RESolution] <Bandwidth>

FM Frequency *FM Frequency* defines how fast the frequency of the FM modulated RF signal changes. The frequency of the modulated signal periodically and continuously oscillates between <Carrier frequency – FM Deviation> and <Carrier Frequency + FM Deviation>. *FM Frequency* is the frequency of this sinusoidal frequency oscillation.

Remote control

SOURce:RFGenerator:MODulation:FM:FREQUENCY <Frequency>

FM Deviation *FM Deviation* defines the frequency deviation of the FM modulated RF signal, i.e. the maximum amount by which the frequency of the modulated RF signal differs from the carrier frequency.

Remote control

SOURce:RFGenerator:MODulation:FM:DEVIation <Deviation>

The following settings are provided separately for the *Tx* and for the *Aux Tx* signal.

Generator Control *Generator Control* controls the RF generator (*Tx* or *Aux Tx*) and indicates its operating state (*ON* | *OFF*).

Remote Control

INITiate:RFGenerator[:TX] INITiate:RFGenerator:AUXTx

ABORt:RFGenerator[:TX] ABORt:RFGenerator:AUXTx

FETCh:RFGenerator[:TX]:STATus?

FETCh:RFGenerator:AUXTx:STATus?

(RF) Level *(RF) Level* defines the total level of the generated RF signals in dBm. The value range depends on the selected RF output (RF 1, RF 2 or RF 3 OUT).

| | | | | | | | |
|----------------------|---|--------|---|---------|---------------------------------|--------|---|
| External attenuation | <p>If an external gain or attenuation is used and reported to the instrument (see softkey <i>Ext. Att. Output</i> in the menu <i>RF</i> \rightarrow on page 4.84) the RF generator level is adjusted to maintain the commanded power after the attenuation or gain. As a consequence, all levels indicated are referenced to the input of the DUT and no longer correspond to the actual level at the output connectors of the R&S® CMU. The default value for the generator power is also shifted provided that the generator can output the required power, compensating for the external attenuation or gain. Otherwise it is adapted to the level closest to the shifted default value.</p> | | | | | | |
| Error messages | <p>If the entered generator level is too high or too low, a window with the error message "<i><Max_Level> is out of range. <permissible max. value> is limit.</i>" and three fields will appear:</p> <table border="0" style="margin-left: 20px;"> <tr> <td style="padding-right: 20px;">Accept</td> <td>The permissible max. value is accepted as RF Level,</td> </tr> <tr> <td>Re-edit</td> <td>RF Level is entered once again,</td> </tr> <tr> <td>Cancel</td> <td>The last valid input value is maintained.</td> </tr> </table> <p>When switching over to another output, the current value of RF Level is automatically adapted, if required:</p> <ul style="list-style-type: none"> • Towards lower values to the maximum permissible value of the new output, • Towards upper values to the minimum value of the new output. | Accept | The permissible max. value is accepted as RF Level, | Re-edit | RF Level is entered once again, | Cancel | The last valid input value is maintained. |
| Accept | The permissible max. value is accepted as RF Level, | | | | | | |
| Re-edit | RF Level is entered once again, | | | | | | |
| Cancel | The last valid input value is maintained. | | | | | | |
| AuxTx Levels | <p>Option R&S CMU-B95 provides a single AuxTx signal at a definite frequency and level. Option R&S CMU-B96 provides two configurable low-level signals (path 1 and path 2) plus an additional overrange signal; see background information above. The level of the path 1 signal can be set in 1dB steps, the level of the path 2 signal in 0.1 dB steps. The overrange signal is switched off by default.</p> <p>Note: <i>Superimposing the Overrange signal with the Tx signal at the same output connector can impair the Tx level accuracy. Refer to the data sheet for option R&S CMU-B96 for details.</i></p> <p>Remote control</p> <pre>SOURce:RFGenerator[:TX]:LEVel <Level> SOURce:RFGenerator:AUXTx:LEVel <Level> SOURce:RFGenerator:AUXTx:LEVel:P<nr> <Level> SOURce:RFGenerator:AUXTx:OLEVel <Level></pre> | | | | | | |
| Frequency | <p><i>Frequency</i> defines the frequency of the generated RF signals.</p> <p>Note: <i>The frequency of the Aux Tx signals is restricted to several distinct ranges. The two signal paths of option R&S CMU-B96 have different frequency ranges; see remote control description. The Overrange signal is always at the frequency of the active low-level signal.</i></p> <p>Remote control</p> <pre>SOURce:RFGenerator[:TX]:FREQuency <Frequency> SOURce:RFGenerator:AUXTx:FREQuency <Frequency> SOURce:RFGenerator:AUXTx:FREQuency <Frequency> SOURce:RFGenerator:AUXTx:FREQuency:P<nr> <Frequency></pre> | | | | | | |
| Path Selection | <p>Selects one of the (low-level) signals configured in the <i>Path 1</i> or <i>Path 2</i> sections. In addition the <i>Overrange</i> signal can be generated at the frequency of the selected low-level signal.</p> <p>Remote control</p> <pre>SOURce:RFGenerator[:TX]:PATH P1 P2</pre> | | | | | | |

The following settings are provided for the Tx signal only.

Frequency Hopping *Frequency Hopping* defines whether Tx is a signal with a single, constant basic frequency (frequency hopping *Off*) or a signal with two alternating frequencies (frequency hopping *On*).

The basic frequency is the *Frequency* set in the *RF Analyzer/Generator* menu. The second (hopping) frequency can be entered in the *Hopping Frequency* input field. Two definitions of the hopping frequency are provided:

Absolute The absolute value of the hopping frequency is entered.

Relative The difference between the hopping frequency and the basic frequency is entered. The resulting absolute frequency, i.e. $f_{abs} = f_{rel} + f_{base}$ must lie in the allowed range for the CMU (see data sheet).

If frequency hopping is selected the RF signal frequency changes after every 4.615 ms: the dwell time at a frequency is as for GSM signals.

Remote control

```
SOURce:RFGenerator:FHOPping:STATe <ON | OFF>
SOURce:RFGenerator:FHOPping:FREQuency <Frequency>
SOURce:RFGenerator:FHOPping:FREQuency:MODE
                                     <ABSolute | RELative>
```

Ramping The *Ramping* parameter defines whether the Tx is a continuous, unmodulated signal (CW signal, Ramping is *Off*) or a series of pulses (Ramping is *On*).

If ramping is *On* the CMU generates rectangular, GSM-like pulses with a duration of 577 μ s.

Remote control

```
SOURce:RFGenerator:PULSe:STATe <ON | OFF>
```

Low Spur Mode Defines whether the mode to reduce the phase noise of the Tx signal is off or on. The CMU meets the specifications of the data sheet irrespective of the *Low Spur Mode* setting, so it is save to keep the default setting if no additional phase noise suppression is required.

Remote control

```
SOURce:RFGenerator:LSMode:STATe <ON | OFF>
```

Generator List Mode

For the *Generator Listmode* the software option CMU-K47 (Smart Alignment) has to be installed.

In list mode the RF generator steps through a series of up to 500 predefined frequencies and levels, dwelling on each frequency/level for a configurable time. The value range for frequency covers the entire configurable value range of the instrument (100 kHz to 2700 MHz), the level range depends on the RF connectors.



The dwell time is constant for all list items, so in order to implement steps with longer dwell times, several list items with identical frequency and level can be repeated in the list.

The associated parameters can be set in the *Generator* tab, which is part of the first group of tabs in the *Connection Control* menu.

The *Generator* tab defines the parameters and the list values for this RF generation sequence.

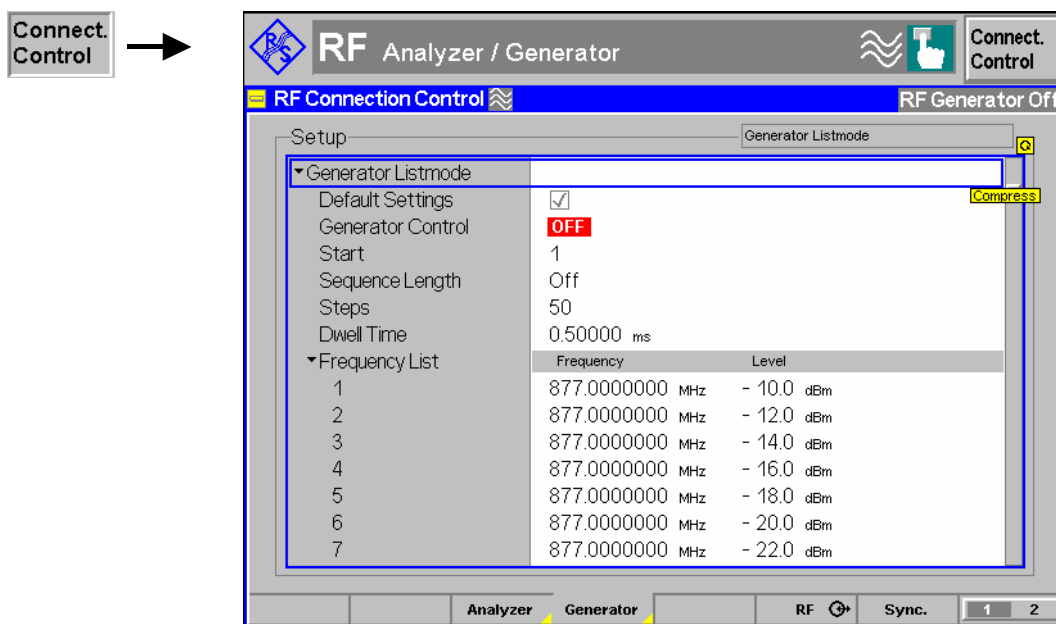

Figure 4-3 RF Configuration Control – Generator List Mode

Generator Listmode - Default Settings The *Default Settings* checkbox assigns default values to all settings *in the Generator Listmode* Control tab (the default values are quoted in the command description in chapter 6 of the operating manual).

Remote control:

```
DEfault:RFGenerator:GLISTmode ON | OFF
```

Generator Control Generator Control controls the RF generator list mode and indicates its operating state (ON | OFF).

Remote control:

```
INITiate:RFGenerator:GLISTmode
ABORt:RFGenerator:GLISTmode
FETCh[:SCALar]:RFGenerator:GLISTmode:STATus?
```

Start Defines the first step of the measured sequence within the frequency list. This value is used only if the generator is confined to a sequence (the *Sequence Length* is set to an integer number of steps).

Remote control:
`SOURce:RFGenerator:GLISTmode:START`

Sequence Length

Defines and enables a sequence within the frequency list.

- If the sequence is inactive (*Sequence Length: Off*), the RF generator uses the entire step range.
- If the *Sequence Length* is set to an integer value, the generator is confined to the sequence.

The sequence is defined by its *Start* (step number) and the *Sequence Length* (integer number of steps).

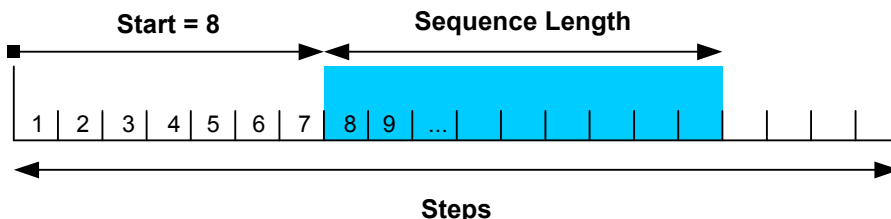

In remote control, it is possible to configure a sequence with all frequencies and levels using a single command. .

Remote control:
`SOURce:RFGenerator:GLISTmode:SLENgth`
`SOURce:RFGenerator:GLISTmode:LIST`

Steps

The number of steps defines the number of list items to be actually processed. For a value of 50 steps this means that list items 1 to 50 are used for list mode measurements and the remaining list items are ignored.

Remote control:
`SOURce:RFGenerator:GLISTmode:STEPs`
`SOURce:RFGenerator:GLISTmode:EOList?`

Dwell Time

The dwell time specifies the duration for each step on the defined frequency/level combination. The dwell time can be set up to 1 s with an accuracy of 10 μ s. The setting range covers the slot lengths of GSM, CDMA, and WCDMA. The increment of 10 μ s is small enough for a suitable approximation of any "real" slot length.

The specified dwell time is constant for all list items, so in order to implement steps with longer dwell times, several list items with identical frequency and level can be repeated in the list.

Remote control:
`SOURce:RFGenerator:GLISTmode:DWELltime`

Frequency List [1 to 500]

The frequency list contains up to 500 list items, each consisting of a frequency and a generator power level.

Frequency The frequency for each of the 500 list items can be set in the defined RF Generator range from 0.1 MHz to 2700 MHz, with an accuracy of 0.1 Hz. The default range is from 877.0 MHz to 926.0 MHz, which roughly covers the GSM850/900 downlink bands.

Remote control:
`SOURce:RFGenerator:GLISTmode:FREQuency[500]`

Level The output power level or each of the 500 list items can be set in the defined output range from -137.0 dBm to -10.0 dBm, with an accuracy of 0.1 dBm. The default range is from -10.0 dBm to -28.0 dBm with increments of -2.0 dBm for each default frequency.

Remote control:

SOURce:RFGenerator:GLISTmode:PLEvel [500]

RF Connectors (Connection Control – RF)

The tab *RF*  configures the connectors for RF input and output signals including the two RF output signals *Tx* and *Aux Tx* (with one of the options R&S CMU-B95 or R&S CMU-B96, *Additional RF Generator*; see section [Generator Settings \(Connection Control – Generator\)](#) on p. 4.76). This includes:

- Selection of the RF signal (*Tx / Aux Tx*)
- The RF input and output of the CMU (*RF Tx Output, RF Tx Input* or *RF AuxTx Output, RF AuxTx Input*)
- An external attenuation at the connectors (*Ext. Att. Output, Ext. Att. Input*)
- The overrange level for the *Aux Tx* signal (*Ovr. Lev. AuxTx*) A frequency-dependent external input and output attenuation (defined after pressing *Ext. Att. Output* or *Ext. Att. Input* twice)

Besides, the tab controls the *Wideband* power meter and displays the result.

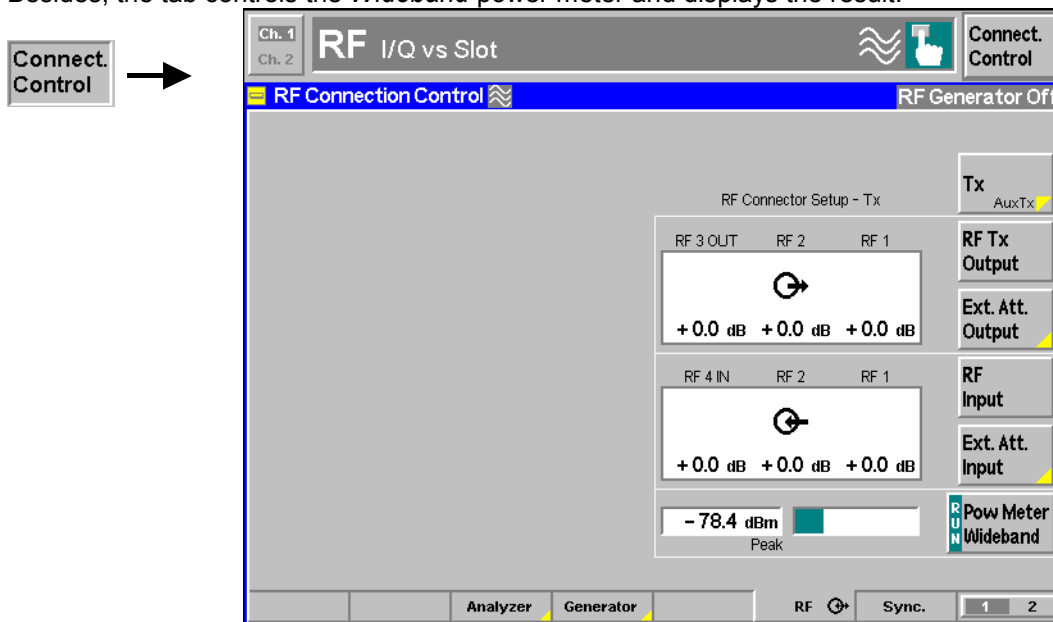

Fig. 4-32 Connection Control – RF connectors



Tx / Aux Tx toggles between the primary RF signal *Tx* and the additional signals *Aux Tx*, to be routed to one of the RF output connectors of the instrument.

The RF signals are independent from each other. It is possible to route the signals to different RF output connectors or superimpose them at the same connector. If *Aux Tx* is selected, *RF Tx Output* changes to *RF Aux Tx Output*, the *RF Input* softkey is replaced by *Ovr. Lev. AuxTx*, and *Ext. Att. Input* by *Ext. Att. Output*.

Remote control

The keywords `[:TX]` and `:AUXTX` in the `OUTPut :... [:STATe]` commands distinguish between the *Tx* and the *Aux Tx* signal.

**RF Tx
Output**

The RF Tx Output softkey defines which of the three connectors RF 1, RF 2 and RF 3 OUT is to be used as RF output connector for the Tx signal. The selected RF output is indicated by a  symbol.

If the additional RF signal *Aux Tx* is selected (see above), the softkey is labeled *RF Aux Tx Output* and selects the output connector for *Aux Tx*. *Aux Tx* must be output at RF1 or RF2.

Note: *Input and output connectors can be combined at will. The bidirectional connectors RF 1 and RF 2 can be selected as RF inputs and outputs at the same time.*

The LEDs on the front panel are only „on“ (light) if the output level is switched on.

Remote control

```
OUTPut[:TX][:STATe] RF1 | RF2 | RF3
OUTPut:AUXTx[:STATe] RF1 | RF2
```

**Ext. Att.
Output**

The softkey *Ext. Att. Output* defines an external attenuation (or gain, if the value is negative) at the selected RF output.

Input of an external attenuation is suitable if, e.g., a path attenuation (cable) is included in the test setup, which is to be compensated for by an increased signal level.

If an external attenuation is defined, the output signal level is referenced to the input of the DUT, the displayed generator level is therefore shifted with respect to the actual level at the output connector of the R&S® CMU. The default value for the generator power and the level ranges for the RF outputs are also shifted provided that the generator can output the required power, compensating for the external attenuation or gain. Otherwise it is adapted to the level closest to the shifted default value.

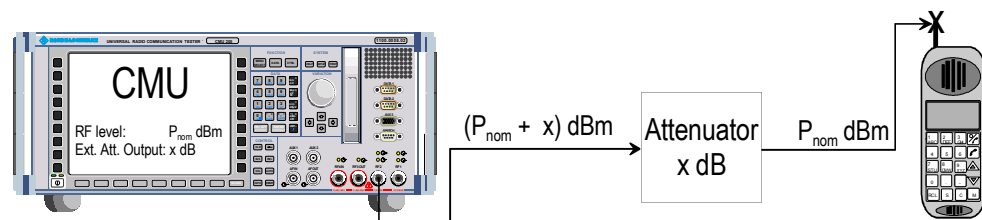
Note: RF User Correction

In addition to the static external output attenuation setting, the CMU provides a systematic correction of the generated RF power by means of user-defined, frequency and level-dependent correction tables; see section RF User Correction in Chapter 1.

**Frequency-
dependent
attenuation**

Pressing *Ext. Att. Output* twice opens a popup menu to define the external input and output attenuation factors as a function of the RF input (analyzer) and output (generator) frequency. See section *Frequency-Dependent External Attenuation* on p. 4.87.

Remote control

```
[SENSe:]CORRection:LOSS:OUTPut<nr>[:TX][:MAGNitude] <Loss>
SOURCE:CORRection:LOSS:OUTPut <nr>[:TX][:MAGNitude] <Loss>
[SENSe:]CORRection:LOSS:OUTPut<nr>AUXTx[:MAGNitude] <Loss>
SOURCE:CORRection:LOSS:OUTPut<nr>AUXTx[:MAGNitude] <Loss>
[SENSe:]CORRection:LOSS:OUTPut<nr>AUXTx:OLEVel[:MAGNitude] <Loss>
SOURCE:CORRection:LOSS:OUTPut<nr>AUXTx:OLEVel[:MAGNitude] <Loss>
```

Ovr. Lev.
AuxTx

The *Ovr. Lev. AuxTx* softkey selects the output connector for the *Overrange* signal (with option R&S CMU-B96). The selected RF output is indicated by a \odot symbol.

Note: *The output connectors for the Overrange signal and the (low-level) AuxTx signal are independent from each other. The following restriction holds for a combination of the Tx and the Overrange signal: While the Overrange signal is at RF 1 the Tx signal cannot be fed to RF 3 OUT and vice versa.*

Superimposing the Overrange signal with the Tx signal at the same output connector can impair the Tx level accuracy. Refer to the data sheet for option R&S CMU-B96 for details.

An attenuation factor for the *Overrange* signal can be defined with the *Ext. Att. Output* softkey below *Ovr. Lev. AuxTx*.

Remote control

```
OUTPut:AUXTx:OLEVel[:STATe] RF1 | RF2 | RF3
```

Ext. Att.
Input

The softkey *Ext. Att. Input* enters the value of the external attenuation (or gain) at the selected RF input.

Input of an external attenuation is required if, for example, external attenuator pads are used for protection of the sensitive RF inputs of the R&S® CMU or if a path attenuation is included in the test setup.

If an external input attenuation is reported to the instrument, all levels measured are referenced to the output of the DUT and therefore shifted with respect to the actual level at the input connectors of the R&S® CMU. The level ranges for the input connectors are shifted as well.

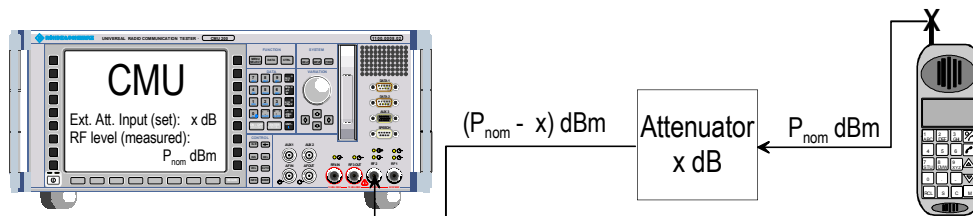

Note: *The LEDs on the front panel are only on (light) if the measurement is active.*

Note: RF User Correction

In addition to the static external input attenuation setting, the CMU provides a systematic correction of the measured RF power by means of user-defined, frequency and level-dependent correction tables; see section RF User Correction in Chapter 1

Frequency-dependent
attenuation

Pressing *Ext. Att. Input* twice opens a popup menu to define the external input and output attenuation factors as a function of the RF input (analyzer) and output (generator) frequency. See section *Frequency-Dependent External Attenuation* on p. 4.87.

Remote control

```
[SENSe:]CORRection:LOSS:INPut<nr>[:MAGNitude]
SOURce:CORRection:LOSS:INPut<nr>[:MAGNitude] <Loss>
```

| |
|--------------------------------|
| Pow. Meter Wideband |
|--------------------------------|

The *Pow. Meter Wideband* softkey controls the wideband power measurement and indicates its status (*RUN* | *HLT* | *OFF*). The status can be changed after softkey selection (pressing once) by means of the *ON/OFF* key or the *CONT/HALT* key. The measurement result is in units of dBm. The analog bar to the right of the softkey shows the measured power relative to the total measurement range (see Chapter 6).

The wideband power measurement is performed at the RF Frontend of the CMU and yields the peak power of the input signal inside a wide frequency range. For modulated RF signals, the result of the wideband power measurement depends on the modulation characteristics. The main purpose of the wideband power measurement is to indicate whether an input signal is available and whether it is advisable to change the *Max Level* settings.

Note: *The RF function group provides a wide selection of power measurements. For an overview see section Analyzer/Generator on p. 4.41.*

Remote control

```
INITiate:WPOWer
FETCh:WPOWer:STATus?
READ[:SCALar]:WPOWer?
FETCh[:SCALar]:WPOWer?
SAMPle[:SCALar]:WPOWer?
```

Frequency-Dependent External Attenuation

The *Freq. Dep. Att.* softkey in the *RF*  tab of the *Connection Control* menu opens a popup menu to define the external input and output attenuation factors as a function of the RF input (analyzer) and output (generator) frequency. The frequency-dependent attenuations have the same meaning and effect as the global (frequency-independent) attenuations *Ext. Att. Input* and *Ext. Att. Output*:

- A positive (negative) output attenuation increases (decreases) the RF generator level so that the generator compensates for the external attenuation or gain.
- A positive (negative) input attenuation increases (decreases) the displayed RF analyzer level so that the displayed result corresponds to the output transmit power of the DUT.

Frequency-dependent attenuations replace the global (frequency-independent) attenuations *Ext. Att. Input* and *Ext. Att. Output*. In contrast to the global attenuations, they are valid for all function groups (in remote control, the commands must be addressed in the R&S CMU base system).

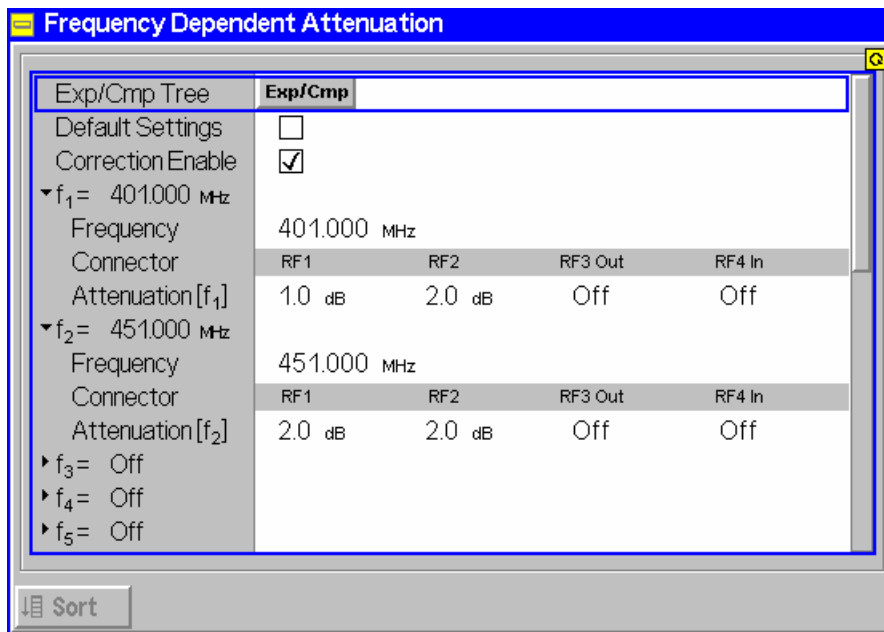



Fig. 4-33 Frequency-dependent attenuation

Default Settings Disables the frequency-dependent correction and sets all frequency values and all external attenuation factors to *Off*.

Correction Enable Enables the frequency-dependent attenuations, causing the global input and output attenuation to be replaced. A red status message in the *RF*  tab indicates that the frequency-dependent attenuations are enabled.

f₁ to f₅₀ List of 50 frequency values, to be set to a specific frequency in the RF input/output frequency range of the R&S CMU (see data sheet) or to *Off*, if the frequency point is not used.

Attenuation External input and output attenuation factors at the frequency point f_n assigned to the four RF connectors *RF1*, *RF2*, *RF3 Out* and *RF4 In*. The values for the bidirectional connectors *RF1* and *RF2* are used as input **and** output attenuations, affecting both the analyzer and the generator. The *RF3 Out* value is an output attenuation, the *RF4 In* value is an input attenuation.

The frequency points don't have to be defined in ascending order. Off the specified frequency points the attenuation factors are calculated as follows:

- In and interval between two adjacent frequency points, the attenuations are linearly interpolated.
- The attenuation at the lowest frequency point is valid for all analyzer and generator frequencies below and up to this frequency.
- The attenuation at the highest frequency point is valid for all analyzer and generator frequencies above this frequency.

Following these rules, it is possible to define attenuation factors for the entire frequency range using an arbitrary number of frequency points between zero (no attenuation) and 50. Using a single frequency point is equivalent to the global (frequency-independent) attenuations *Ext. Att. Input* and *Ext. Att. Output*.

Generator *RF Level* and analyzer *Max. Level* ranges

In analogy to the global attenuation factors *Ext. Att. Input* and *Ext. Att. Output*, the frequency-dependent attenuation factors modify the setting ranges for the generator and analyzer level.

- A positive (negative) output attenuation decreases (increases) the setting range of the RF generator level because the actual generator level must be larger (smaller) than the setting value.
- A positive (negative) input attenuation increases (decreases) the maximum analyzer level (RF Max. Level) because the displayed analyzer level result is larger (smaller) than the actual level at the input connectors of the R&S CMU.

To avoid conflicting level settings at varying input and output frequencies, the R&S CMU restricts the generator and analyzer setting ranges according to the maximum and minimum attenuation settings.



Sorts the frequencies f_1 to f_{50} in ascending order.

Remote control:

The commands for the frequency-dependent attenuation are part of the CMU base system:

```

DEfault:USER:CORRection:LOSS
CONfFigure:USER:CORRection:LOSS:TABLE:ENABLE
CONfFigure:USER:CORRection:LOSS:TABLE:LINE<nr>
CONfFigure:USER:CORRection:LOSS:TABLE?
SORT:USER:CORRection:LOSS:TABLE
    
```

Reference Frequency (Connection Control – Sync.)

The *Sync.* tab determines the reference signals for synchronization. This includes

- The internal or external *Reference Frequency*
- The output mode for the network-specific system clock (*REF OUT 2*).

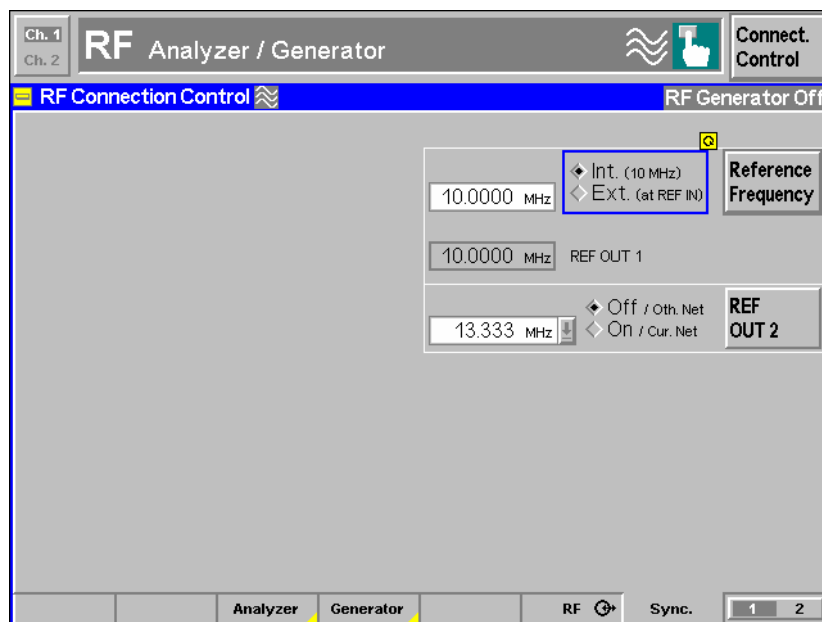
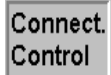

Fig. 4-34 Connection Control – Synchronization

| |
|------------------------|
| Reference Frequency |
|------------------------|

The *Reference Frequency* softkey determines the source and the frequency of the reference signal. The associated field allows to select between two alternatives:

- Int. (10 MHz)* Internal synchronization by means of a 10 MHz reference frequency (TCXO or OCXO, R&S CMU-B11/-B12).
- Ext. (at REF IN)* Synchronization to external reference signal to be fed in via input REF IN. The external reference signal can be used for synchronization of the R&S® CMU to another instrument. Its frequency must be entered in the input field next to the *External* button.

The reference signal used is also routed to output *REF OUT 1* so that it can be fed to other instruments as well.

Note: *The instrument periodically displays a warning if no synchronization could be achieved e.g. because of missing or faulty input signal with external synchronization selected. At the same time, bit no. 6 (RFNL, Reference Frequency Not Locked) is set in the STATUS:OPERation:CMU:SUM1:CMU1 sub-register associated with the R&S® CMU base system and the query [SENSe:]SYNChronize:FREQuency:REFerence:LOCKed? returns the value ON.*

In the case of external synchronization with squarewave signals (TTL) ensure correct signal matching to avoid reflections. Otherwise, resulting overshoots may cause trigger problems at the R&S® CMU input. A possible remedy is to use a lowpass filter or an attenuator pad directly at the R&S® CMU input. Correct synchronization may be checked by comparing the signal REF OUT 1 with the input signal.

This configuration is valid in all R&S® CMU function groups.

Caution: *The reference frequency is set to Int. (10 MHz) whenever the base system is reset. After switching back to Ext. (at REF IN) it is necessary to allow for a setting time (~1 s) before the R&S® CMU can synchronize to the external reference frequency. The delay is avoided by a partial reset of all function groups with the exception of the base system.*

Remote control

The commands for the reference frequency are part of the R&S® CMU base system:

```
CONFigure:SYNChronize:FREQuency:REFerence:MODE
    INTernal | EXTernal
CONFigure:SYNChronize:FREQuency:REFerence <Frequency>
[SENSe:]SYNChronize:FREQuency:REFerence:LOCKed?
```

REF
OUT 2

The softkey REF OUT 2 configures a network-specific system clock REF OUT 2 to be fed to the output REF OUT 2 at the rear of the instrument. The clock frequency can be used to synchronize other instruments to the CMU.

The associated field permits to select between two alternatives:

OFF (other network) The clock frequency of the current function group is not fed to the output REF OUT 2.

With this setting the system clock of another active function group (e.g. the network GSM1800 while the current network is GSM900) is still applied to REF OUT 2 provided that the output REF OUT 2 is switched on in the other function group. However, if REF OUT 2 is explicitly switched over from On to Off the clock signal is definitely removed.

On (current network) The network-specific system clock of the current function group is fed to output REF OUT 2. The system clock of any other function group applied to REF OUT 2 before is replaced.

Besides the basic clock frequency of 40 MHz one of the following clock frequencies may be selected:

| | | | | | | |
|-------------|-------------|-------------|-------------|------------|------------|------------|
| 40.000 MHz, | 20.000 MHz, | 13.334 MHz, | 10.000 MHz, | 8.000 MHz, | 6.667 MHz, | 5.715 MHz, |
| 5.000 MHz, | 4.445 MHz, | 4.000 MHz, | 3.637 MHz, | 3.334 MHz, | 3.077 MHz, | 2.858 MHz, |
| 2.667 MHz, | 2.500 MHz, | 2.353 MHz, | 2.223 MHz, | 2.106 MHz, | 2.000 MHz, | 1.905 MHz, |
| 1.819 MHz, | 1.740 MHz, | 1.667 MHz, | 1.600 MHz, | 1.539 MHz, | 1.482 MHz, | 1.429 MHz, |
| 1.380 MHz, | 1.334 MHz, | 1.291 MHz, | 1.250 MHz, | | | |

(The values are calculated according to the formula $F_{\text{out } 0} = 40.000 \text{ MHz} / n$ where $n = 1, \dots, 32$.)

Remote control

SOURce:DM:CLOCK:STATe ON | OFF

SOURce:DM:CLOCK:FREQuency <Frequency>

Trigger (Connection Control – Trigger)

The *Trigger* tab is part of the second group of tabs in the *Connection Control* menu. It is accessible after pressing the 1 / 2 toggle hotkey once. Pressing 1 / 2 again switches back to the first group of tabs described above.

The *Trigger* tab defines the trigger condition for the measurement and the input for the external trigger signal.

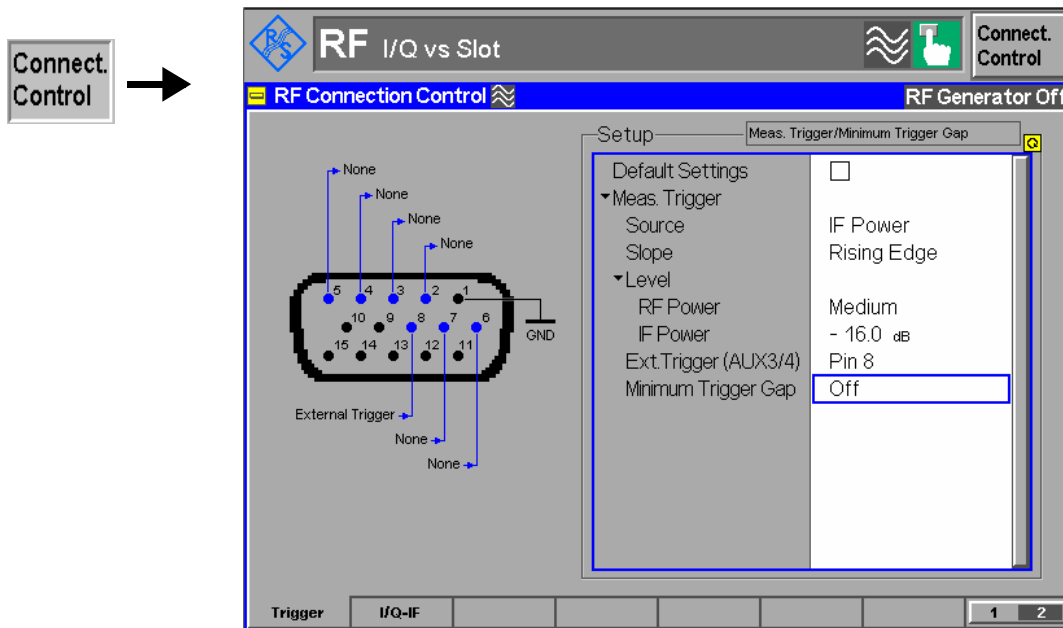

Fig. 4-35 Connection Control – Trigger

Default Settings The *Default Settings* checkbox assigns the default setting to all functions in the *Trigger* tab (the default values are quoted in the command description in chapter 6 of this manual).

Remote control `TRIGger[:SEquence]:DEFault ON | OFF`

Meas. Trigger – Source *Source* selects the source for the trigger event:

- Free Run* Free-run mode, the measurement is carried out continuously, it is not related to the input signal
- RF Power* The measurement is triggered by the level (rising or falling edge; see *Slope* setting below) of the measured RF signal
- IF Power* The measurement is triggered by the level of the IF signal
- External* External trigger signal fed in via connector AUX3 (pin no. 8)

For the *RF Power* and *IF Power* trigger the trigger level is specified via the *Level* parameters. *RF Power* trigger signals have a small dynamic range which may not be sufficient for triggering. It is recommended to trigger by the *IF Power* instead.

Note: *If no measurement result can be obtained the trigger mode may not fit to the trigger signal applied. Check the trigger mode and signal.*

Remote control `TRIGger[:SEquence]:SOURce IMMEDIATE | RFPower | IFPower | EXtern`

Level The *Level* section defines the trigger thresholds if the measurement is triggered by the *RF Power* or *IF Power* (see *Source* function above). Both thresholds are defined relative to the maximum input level set in the *Analyzer* tab (see *RF Max. Level* soft-key on p. 4.74). The *Level* settings have no influence on *Free Run* or *External* trigger measurements.

Note: *The trigger levels are always relative to the current maximum input level. If RF Max. Level is set manually (RF Mode = Manual), the current input level is constant and equal to the setting value. In autoranging mode (RF Mode = Auto), the current maximum input level is dynamically adapted to the measured RF input level; the trigger levels change accordingly.*

The **RF Power** trigger threshold is the RF input signal level (*Wideband Power*, see p. 4.86) beyond which the trigger condition is satisfied and a measurement is initiated.

Low Low trigger threshold, equal to approx. the *RF Max. Level* – 26 dB

Medium Medium trigger threshold, equal to approx. the *RF Max. Level* – 16 dB

High High trigger threshold, equal to approx. the *RF Max. Level* – 6 dB

The **IF Power** trigger threshold is the IF trigger signal level beyond which the trigger condition is satisfied and a measurement is initiated. The *IF Power* input value defines the trigger threshold relative to the maximum input level:

$$\text{IF power trigger threshold} = \langle \text{RF Max. Level} \rangle + \langle \text{IF Power} \rangle$$

Remote control

```
TRIGger[:SEquence]:THReshold:RFPower LOW | MEdium | HIGH
```

```
TRIGger[:SEquence]:THReshold:IFPower <Power>
```

Slope *Slope* qualifies whether the trigger event occurs on the *Rising Edge* or on the *Falling Edge* of the trigger signal. The setting has no influence on *Free Run* measurements.

Remote control

```
TRIGger[:SEquence]:SLOPe POSitive | NEGative
```

Ext. Trigger (AUX 3/4) *Ext. Trigger (AUX 3/4)* qualifies whether the external trigger signal is fed in at *Pin 6*, *Pin 7*, or *Pin 8* of the AUX 3 connector. The setting only has effect if the trigger source is an *External* signal.

The CMU can be ordered with the auxiliary connector AUX 4 on the rear panel configured as an external trigger input. In this case the *Ext. Trigger...* pin selection refers to AUX 4; the front panel connector AUX 3 is disconnected.

Remote control

```
TRIGger[:SEquence]:SLOPe:EXTernal PIN6 | PIN7 | PIN8
```

Minimum Trigger Gap The *Minimum Trigger Gap* parameter defines the time (in μs) before a trigger event can be generated. For example, with a defined rising edge trigger slope the trigger is armed only after the corresponding signal is low for the time period defined by the minimum trigger gap.

Trigger events automatically reset the gap time counter. The minimum trigger gap is therefore valid before all trigger events.

The *Minimum Trigger Gap* time prevents the CMU to generate unwanted trigger events, which may result from e.g. 8PSK-modulated signal bursts with typical power dips within the burst.

If the measurement is started during such a burst, the dips could cause an unwanted trigger event, which can be avoided by setting an appropriate gap time.

The maximum gap time is 1000 μs . OFF corresponds to a 0 μs gap time.

Remote control:

TRIGger[:SEquence]:MTGap <Value in μs > | OFF

I/Q-IF Interface (Connection Control – I/Q-IF)

The *I/Q-IF* tab is part of the second group of tabs in the *Connection Control* menu. It is accessible after pressing the 1 / 2 toggle hotkey once. Pressing 1 / 2 again switches back to the first group of tabs described above.

The *I/Q-IF* tab configures the signal paths for I/Q and IF signals. With option CMU-B17, *I/Q and IF Interfaces*, I/Q and IF signals can be used in the framework of RF measurements and in many network tests. For a detailed description of rear panel connectors for I/Q and IF input/output signals, test scenarios and application examples refer to section *I/Q and IF Interface* (Option CMU-B17) on p. 4.124.

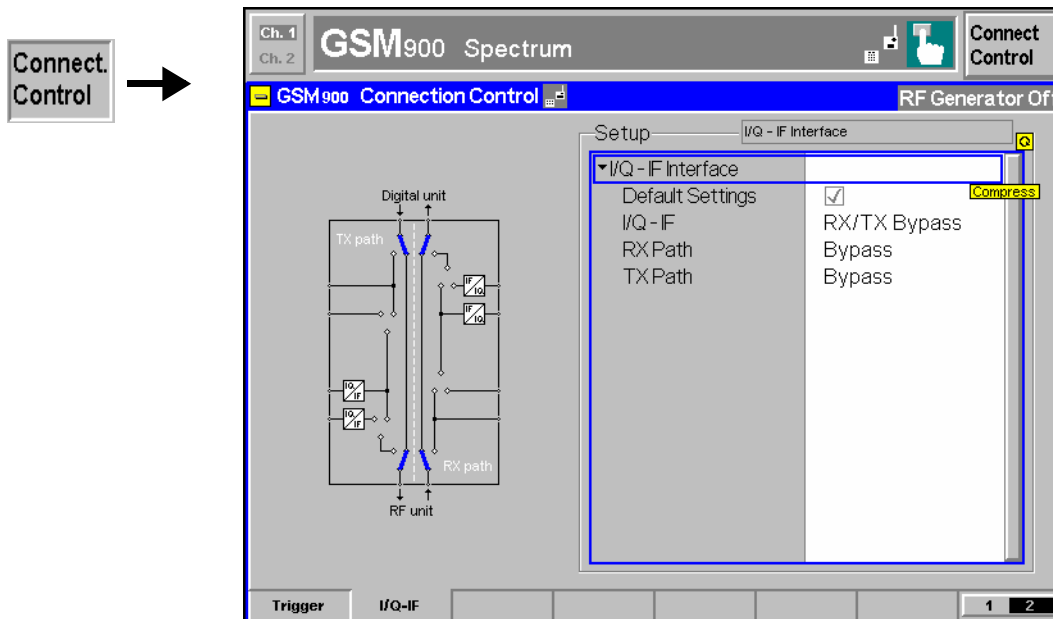

Fig. 4-4 Connection Control – I/Q-IF

Default Settings The *Default Settings* checkbox assigns the default setting to all functions in the *I/Q-IF* tab.

| | |
|----------------------------------|---|
| Remote control I/Q-IF | <p>IQIF:DEFault ON OFF</p> <p>Selects the I/Q-IF test scenario, overwriting the current <i>RX Path</i> and <i>TX Path</i> settings. Six different predefined test scenarios with fixed RX and TX path are provided; see Table 4-3 below.</p> <p>Additional scenarios may be defined by selecting any other combination of RX and TX paths. When this is done <i>I/Q-IF</i> is set to <i>User-defined</i>. The circuit diagram to the left of the <i>Setup</i> table shows the current RX and TX signal paths.</p> |
| Remote control | <p>CONFigure:IQIF:RXTXcombined BYP BYIQ XOIO IOIO IOXO FPAT UDEF</p> |
| RX Path | <p>Selects the RX signal path, leaving the <i>TX Path</i> unchanged but adapting the I/Q-IF test scenario to the new RX/TX path combination: If the combination corresponds to a predefined scenario, then <i>I/Q-IF</i> is set to the predefined scenario; otherwise it is set to <i>User-defined</i>.</p> <p>The circuit diagram to the left of the <i>Setup</i> table shows the current RX and TX signal paths.</p> |
| Remote control | <p>CONFigure:IQIF:RXPath BYP BYIQ XOIO IOIO IOXO FPAT UDEF</p> |
| TX Path | <p>Selects the TX signal path, leaving the <i>RX Path</i> unchanged but adapting the I/Q-IF test scenario to the new RX/TX path combination: If the combination corresponds to a predefined scenario, then <i>I/Q-IF</i> is set to the predefined scenario; otherwise it is set to <i>User-defined</i>.</p> <p>The circuit diagram to the left of the <i>Setup</i> table shows the current RX and TX signal paths.</p> |
| Remote control | <p>CONFigure:IQIF:TXPath BYP BYIQ XOIO IOIO IOXO FPAT UDEF</p> |

Table 4-3 I/Q-IF scenarios and path settings

| I/Q-IF | RX Path | TX Path | Remark/Application (see also CMU manual) |
|-------------------|---|----------------------|---|
| RX/TX Bypass | Bypass | Bypass | No I/Q or IF inputs/outputs connected Direct signal analysis and transmission with full measurement accuracy |
| By. w. I/Q-OF OUT | Bypass w. I/Q-IF OUT | Bypass w. I/Q-IF OUT | No I/Q or IF inputs connected Analysis of received and transmitted signal via I/Q or IF |
| I/Q IN/OUT | I/Q IN/OUT | I/Q IN/OUT | Insertion of signal to be analyzed and transmitted on I/Q level |
| IF IN_I/Q IN/OUT | IF IN_I/Q IN/OUT | IF IN_I/Q IN/OUT | Additional processing of received and transmitted signal on IF level (filters etc.) and analysis via I/Q |
| IF IN/OUT | IF IN/OUT | IF IN/OUT | Insertion of signal to be analyzed and transmitted on IF level |
| Fading | Bypass | I/Q IN/OUT | Direct analysis of received signal Modification (fading) of transmitted signal by means of an external fading simulator (SMIQ, ABFS) |
| User-defined | Any combination of RX Path and TX Path not listed above | | Any combination of RX and TX test cases listed above |

Options and Extensions

The function groups described in this section require the installation of hardware options; for a complete list of deliverable options refer to the data sheet. Software options for digital and analog network tests are described in separate operating manuals; for a list refer to the *Manuals* section before tabbed divider no. 1 of this manual.

Audio Option (R&S CMU-B41)

The *Audio Option* R&S CMU-B41 provides an additional *Audio* function group comprising the functions for generating and measuring audio signals. It can be accessed either from the *Menu Select* menu (standalone audio measurements) or by switching over from any of the *GSM-MS*, *cdmaOne (IS 95)-MS*, *CDMA2000*, or *TDMA (IS 136)-MS*, or *Bluetooth* measurement menus. In the latter case, the audio circuit of a Bluetooth DUT can be tested without releasing a connection or changing the signalling state of the R&S CMU.

Standalone *audio* measurements are performed with default connector settings, the audio signals being applied to the connectors *AF IN / AUX 1* (input) and *AF OUT / AUX 2* (output) on the front panel of the instrument (see chapter 1 of the operating manual). If *Audio* is used in the context of the network tests (*Signalling* test mode), the *AF/RF*  tab of the associated *Connect. Control* menu allows to select the input source of the R&S CMU speech encoder and the output destination of its speech decoder (for more information refer to the relevant network operating manuals).

The audio function group provides the following independent measurements:

- In a single-tone audio measurement (*Analyzer/Generator* menu), the R&S CMU generates an audio signal at constant level and frequency and analyzes a single-tone audio input signal.
- In a multitone measurement, the R&S CMU generates a composite audio signal consisting of up to 20 distinct test tones and analyzes an audio input signal containing the same tones.
- In the total harmonic distortion (THD) measurement, the R&S CMU provides a single-frequency audio test signal with adjustable power and very low harmonic distortion and measures the AF power at the generator frequency (1st harmonic labeled d1) and at the 2nd, 3rd ... 9th harmonics.

Two independent audio circuits are provided for each measurement. The *Stereo* applications for the *Multitone* and *THD* measurements are combinations of the primary and secondary circuit applications.

Analyzer/Generator Menu

The main menu *Analyzer/Generator* defines the DC or sinusoidal AC signals generated by the two audio generators and displays the voltage of the two measured audio signals.

- The measurement control softkey *Analyzer 1*, which changes to *Analyzer 2*, depending on the audio measurement application selected) controls the measurement, indicates its status (*RUN | HLT | OFF*) and opens the configuration menu *Audio Configuration*. The hotkeys associated with the measurement control softkey define the scope of the *Audio* measurement.
- The other softkeys to the right of the test diagram are combined with various hotkeys (e.g. the hotkeys *AF Max. Level* and *AF Mode* belong to the softkey *Analyzer Level*). The softkey/hotkey combinations provide test settings and switch over between different measurements.

The *Analyzer/Generator* menu is opened from the main menu *Menu Select* (with associated key at front of instrument) or via the *Audio* hotkey which is available in all *GSM-MS*, *cdmaOne (IS 95)-MS*, *CDMA2000*, *TDMA (IS 136)-MS*, or *Bluetooth* measurement menus. Compared to the standalone case, the network audio option offers an extended functionality (see [Fig. 4-36](#) below):

- The *Connect*. *Control* softkey from the previous (calling) network function group is also available in *Audio*. The corresponding menu is described in the relevant operating manuals; see overview of R&S CMU documentation at the beginning of the present CMU manual.
- A symbol indicating the network test mode (e.g. @ *Bluetooth*) is displayed in the menu header.
- A hotkey switching back to the network function group shows at the bottom of the menu.

The actual *Audio* functionality is identical in the standalone and network modes.

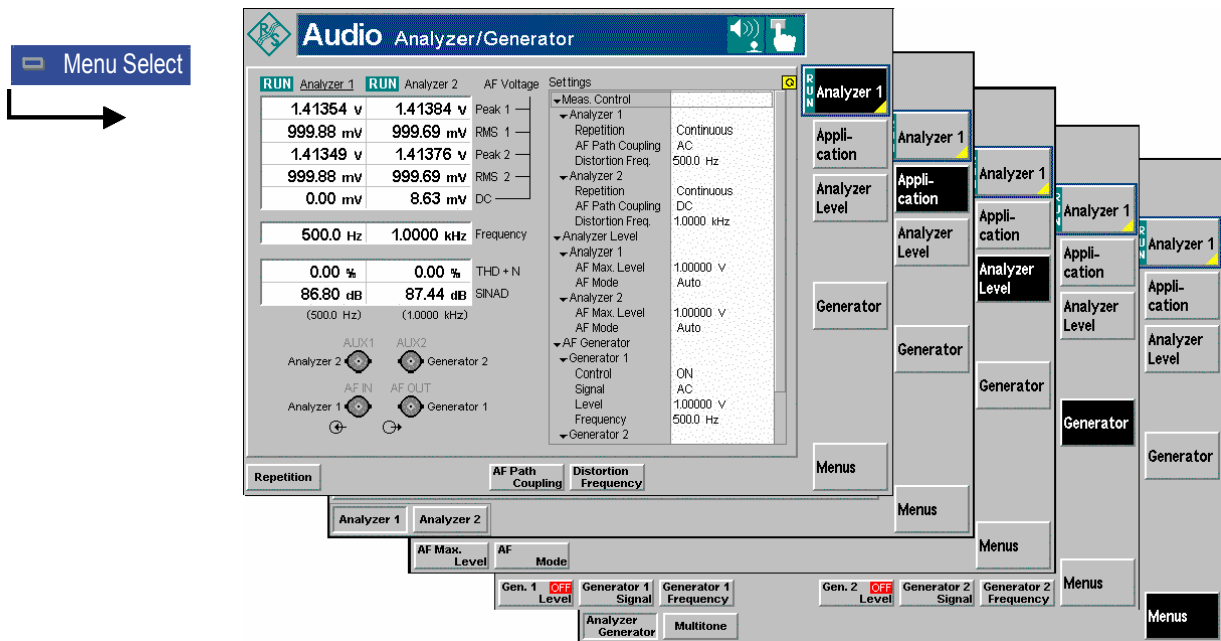

Fig. 4-36 Measurement menu Analyzer/Generator (Audio)

Test Settings

The basic settings for the *Audio* measurement are directly accessible from the measurement menu via softkey/hotkey combinations. The entry of values is described in section [Test settings](#) on p. 4.49.

Many of the basic settings are also accessible from the *Analyzer Configuration* popup menu. They are explained in more detail in section [Measurement Configurations \(Analyzer Configuration\)](#) on p. 4.102.

Analyzer 1

The *Analyzer 1/2* softkey (which changes to *Analyzer 2*, depending on the application selected) controls the audio measurement (RUN / HLT / OFF) and indicates its status. This status can be changed after softkey selection (pressing once) by means of the ON/OFF key or the CONT/HALT key. The status can be set independently for all *Audio* applications.

Remote control

```
INITiate:AFANalyzer:<Applic>
STOP:AFANalyzer:<Applic>
ABORT:AFANalyzer:<Applic>
CONTinue:AFANalyzer:<Applic>
```

```
FETCh:AFANalyzer:<Applic>:STATus?
```

```
<Applic> = [PRIMary] | SECondary
```

Measurement configuration

Pressing the *Analyzer* softkey twice opens the popup menu *Analyzer Configuration*; see p. 4.102. Besides, the measurement control softkey provides hotkeys to define the path coupling and a possible distortion frequency. All these settings are de-

scribed in more detail in section [Measurement Control \(Analyzer Configuration – Control\)](#) on p. 4.102.

Appli- cation

The Application softkey selects the audio measurement application.

The results of both applications *Analyzer 1* and *Analyzer 2* are indicated in the corresponding columns of the output tables; see section [Measurement Results](#) on p. 4.100. The *Settings* table shows the measurement configurations for both applications. On the other hand, all softkeys and hotkeys in the measurement menu belong to the current application.

Analyzer 1

Analyzer 1 selects the primary audio circuit where the audio signals are applied to the connectors AF OUT (output, AF generator signal) and AF IN (input) on the R&S CMU front panel.

Remote control:

The *Analyzer 1* application is selected by the keyword `[:PRIMary]` in the 3rd level of the analyzer commands, e.g. `INITiate:AFANalyzer[:PRIMary]`.

Analyzer 2

Analyzer 2 selects the secondary audio circuit where the audio signals are applied to the connectors AUX 2 (output, AF generator signal) and AUX 1 (input) on the R&S CMU front panel.

Remote control:

The *Analyzer 2* application is selected by the keyword `:SECondary` in the 3rd level of the analyzer commands, e.g. `INITiate:AFANalyzer:SECondary`.

Analyzer Level

The *Analyzer Level* softkey controls the level in the AF input signal path.

AF Max. Level

The *AF Max. Level* hotkey sets the maximum expected AF input level. Levels exceeding this value cannot be measured.

The level is entered in mV.

Remote control

```
[SENSE:]AFLEVel<Applic>:MAXimum <Level>
      <Applic> = [:PRIMary] | :SECondary
```

Error messages

If the value set for *Manual Level* is too high or too low, a window with the error message "*<Max_Level> is out of range. <permissible max. value> is limit.*" and three fields will appear:

| | |
|----------------|--|
| <i>Accept</i> | The permissible max. value is accepted as maximum input level. |
| <i>Re-edit</i> | The <i>Manual Level</i> is entered once again. |
| <i>Cancel</i> | The last valid input value is maintained. |

| |
|------------|
| AF Mode |
|------------|

The *AF Mode* hotkey determines how the input level is defined.

Manual Manual input of maximum input level via *Manual Level* (in mV).
Auto Automatic setting of maximum input level (*autoranging*) according to average power of applied AF signal (plus an appropriate overload margin).

Note1: *A maximum input level can be entered even if automatic level setting (autoranging) is selected. It serves as a start value for the autoranging algorithm and is important to ensure safe switchover to manual setting.*

Note2: *The AF Max. Level and AF Mode settings supersede the corresponding settings in the Multitone menu (Analyzer 1/2); see hotkeys [AF Max. Level](#) on p. 4.109 and [AF Mode](#) on p. 4.109.*

Remote control

```
[SENSE:]AFLevel<Applic>:MODE MANual | AUTomatic
<Applic> = [:PRIMary] | :SECondary
```

| |
|-----------|
| Generator |
|-----------|

The *Generator* softkey controls the audio generator and defines the properties of the generated DC or sinusoidal AC signal. The three hotkeys for the primary and secondary audio circuit (*Gen. 1/Gen. 2*) are analogous.

The generator settings are also provided in the *Analyzer Configuration* menu; see section [Generator Settings \(Analyzer Configuration – Generator\)](#) on p. 4.104.

| |
|-----------|
| Bluetooth |
|-----------|

The hotkey switches back to the previous GSM function group.

This hotkey is available if the *Analyzer/Generator* menu is opened from a GSM function group. The hotkey is labeled with the calling function group and test mode, which is also displayed in the menu header.

Remote control

All function groups for network tests are referenced by their secondary addresses; see Chapter 5 of the operating manual.

Measurement Results

The test settings of the *Audio* measurement and the results are displayed in the tables in the center of the menu.

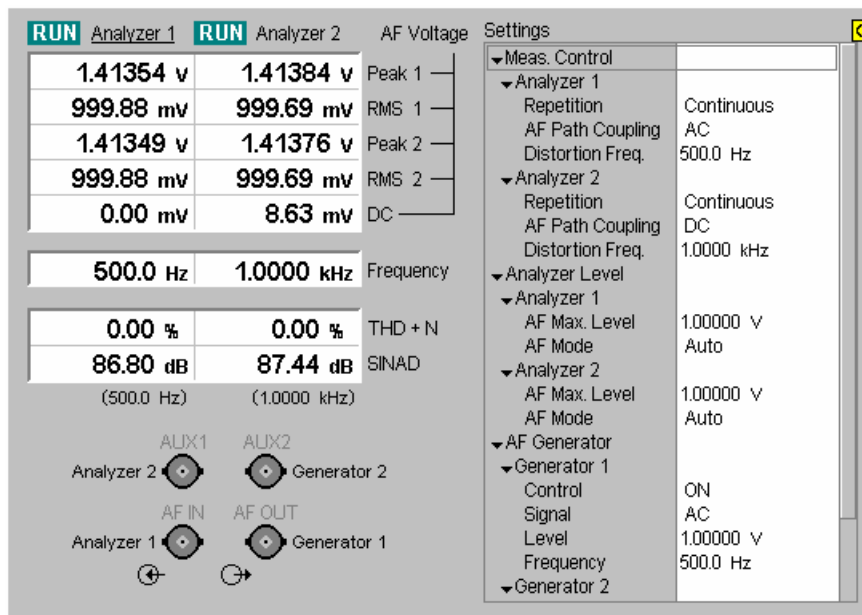

Fig. 4-37 Display of test settings and measurement results (Audio)

Results

The table and output fields in the left half of the table show the results for both audio circuits (applications *Analyzer 1* and *Analyzer 2*). If an analyzer is switched off (see measurement control softkey *Analyzer 1* on p. 4.97), *OFF* is indicated above the corresponding output column and the output fields show invalid results ("---").

The values in the *AF Voltage* table represent the measured voltages of the AF signals:

Peak 1/2

Peak value of the AC component of the measured AF signal in V. The numbers 1 and 2 denote two different input paths for AF signals with different filter configuration; see Fig. 4-40 on p. 4.105.

| | |
|------------------|--|
| <i>RMS 1/2</i> | Effective (RMS-averaged) value of the AC component of the measured AF signal in V. |
| <i>DC</i> | DC component of the measured AF signal in V |
| <i>Frequency</i> | Frequency of the measured AC signal |
| <i>THD + N</i> | Ratio of the measured AF signal voltage with a notched-out reference frequency to the complete measured AF signal in percent. The reference frequency of the distortion measurement set in the <i>Control</i> tab of the configuration menu (see p. 4.102) is indicated in brackets below the output field. If the reference frequency is equal to the fundamental frequency of the AF signal, the <i>THD + N</i> value corresponds to the <i>Total Harmonic Distortion and Noise</i> . To avoid suppression of the first harmonic, the bandwidth of the notch filter is automatically adjusted to be smaller than the reference frequency. |
| <i>SINAD</i> | Signal-to-Noise-and-Distortion ratio calculated from the THN+D value as follows: |

$$\text{SINAD(in dB)} = 20 \times \log\left(\frac{1}{(\text{THN} + \text{D(in \%)} / 100)}\right)$$

Example: A THN+D factor of 1% results in a SINAD of 40 dB.

Remote control

```
READ[:SCALar]:AFANalyzer:<Applic>[:RESult]?
FETCh[:SCALar]:AFANalyzer:<Applic>[:RESult]?
SAMPle[:SCALar]:AFANalyzer:<Applic>[:RESult]?
```

AF Connector Overview

The figure below the result table shows the destination of the input signals fed in via AF IN and AUX 1 and the signal sources for the two audio output connectors AF OUT and AUX 2.

- For standalone audio measurements and network tests in *Non Signalling* mode the routing of input and output audio signals is fixed: The connectors AF IN and AF OUT are used as input and output for the primary audio circuit (Analyzer 1, Generator 1). AUX 1 and AUX 2 are used as input and output for the secondary audio circuit (Analyzer 2, Generator 2).
- If network tests are performed in *Signalling* mode and a speech codec is available, the routing of input and output audio signals is a function of the *Speech Decoder* output destination. For more information refer to the network test manuals.

Settings

The *Settings* table gives an overview of the configuration of the current measurements. This includes the settings made via the softkeys and hotkeys of the *Audio* menu.

Remote control

Settings are read out using the query corresponding to the setting command (setting command with appended question mark). See section [Test Settings](#) on p. 4.97.

Measurement Configurations (Analyzer Configuration)

The popup menu *Analyzer Configuration* contains three tabs to determine the parameters of the *Audio* measurement. It is opened by pressing the softkey *Analyzer* in the measurement menu *Analyzer/Generator* twice. It is possible to change between the tabs by pressing the associated hotkeys.

The popup menu *Analyzer Configuration* is activated by pressing the measurement control softkey at the top right in the graphical measurement menu *Power* twice. It is possible to change between the tabs by pressing the associated hotkeys.

Measurement Control (Analyzer Configuration – Control)

The *Control* tab determines:

- The *Repetition* mode,
- The *AF Path Coupling* of the audio measurement.
- The reference frequency of the distortion measurement (*Distortion Frequency*).

The settings can be defined independently for the applications *Analyzer 1* and *Analyzer 2*.

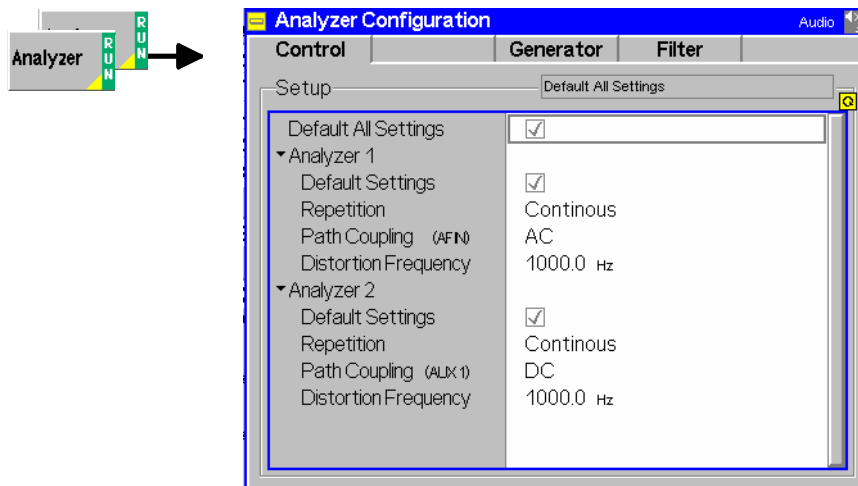

Fig. 4-38 Analyzer Configuration – Control

Default Settings The *Default* switch assigns default values to all settings in the *Control* tab (the default values are quoted in the command description). In addition, default switches for the individual applications are provided.

Remote Control

–

Repetition The *Repetition* field determines the repetition mode, see Chapter 3 of the operating manual and explanations given on page 4.53 for the *Power* measurement. In *Audio*, one statistics cycle is terminated when the system has settled and a valid result is available.

Remote control

```
CONFigure:AFANalyzer:<Applic>:CONTRol:REPetition
    CONTinuous | SINGleshot | 1 ... 10000,NONE,<Stepmode>
```

**Path
Coupling**

Path Coupling sets the input path for measurement of the AC or AC and DC component of the AF signal:

AC DC component of the measured AF signal (including a possible DC offset of the input amplifier) blocked. This ensures accurate measurement of the AC component. The DC component, however, can not be measured; the DC Voltage output field in the Analyzer/Generator menu indicates "---".

DC Measurement of the complete AF input signal (DC plus AC components).

Note: *The path coupling has an impact on the allowed filter settings; see section [Input Path Configuration \(Analyzer Configuration – Filter\)](#) on p. 4.104.*

Remote control

```
CONFigure:AFANalyzer:<Applic>:CONTrol:COUpling AC | DC
```

**Distortion
Frequency**

Distortion Frequency defines the reference frequency of the distortion measurement. If the reference frequency is set to the fundamental frequency of the AF signal, the *Distortion* value corresponds to the Total Harmonic Distortion and Noise.

Remote control

```
CONFigure:AFANalyzer:<Applic>:CONTrol:DIS TORTion:FREQuency
```

Generator Settings (Analyzer Configuration – Generator)

The *Generator* tab defines the properties of the generated AF signals. The settings can be defined independently for the two AF generators.

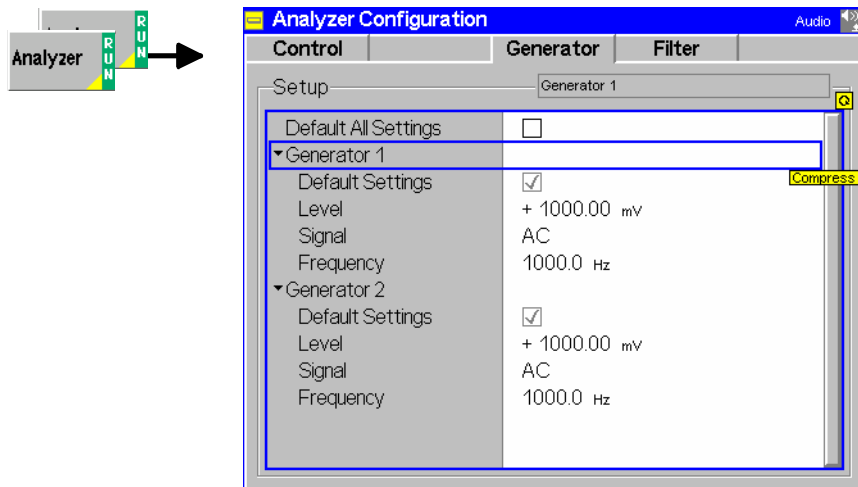

Fig. 4-39 Analyzer Configuration – Generator

Default Settings The *Default Settings* switch assigns default values to all settings in the *Generator* tab (the default values are quoted in the command description in chapter 6). In addition, default switches for the two independent generators are provided.

Remote Control

–

Level *Level* defines the generator level. The meaning of the entered level depends on the generator signal type (see *Signal* below):

- If the generated signal is an AC signal, *Level* denotes the effective (RMS averaged) voltage.
- If the generated signal is a DC signal, *Level* denotes the constant DC voltage.

The level is entered in mV.

Remote control

```
SOURce:AFGenerator:<Applic>:LEVel <Level>
```

Signal *Signal* qualifies whether the generated audio signal is a DC or an AC signal.

Remote control

```
SOURce:AFGenerator:<Applic>:SMODE DC | AC
```

Frequency *Frequency* sets the frequency of the generated AF audio signal in Hz. The hotkey is disabled if the generated signal is a DC signal.

Remote control

```
SOURce:AFGenerator:<Applic>:FREQuency <Frequency>
```

Input Path Configuration (Analyzer Configuration – Filter)

The *Filter* tab configures the different filter stages for the AF analyzer. The input path for measuring the AC component of the AF signal is as shown below:

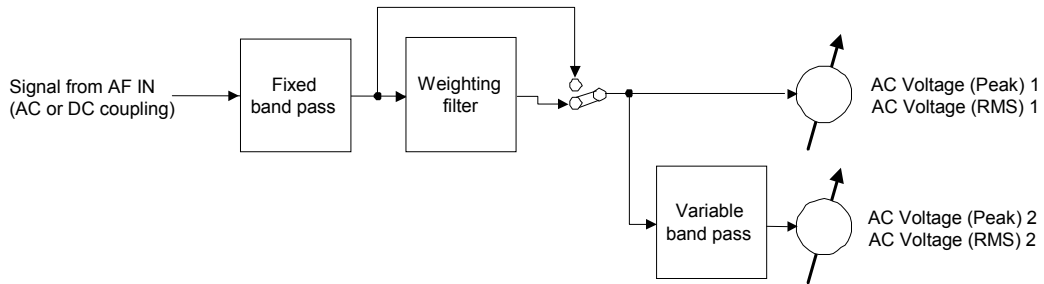

Fig. 4-40 AF analyzer input path configuration

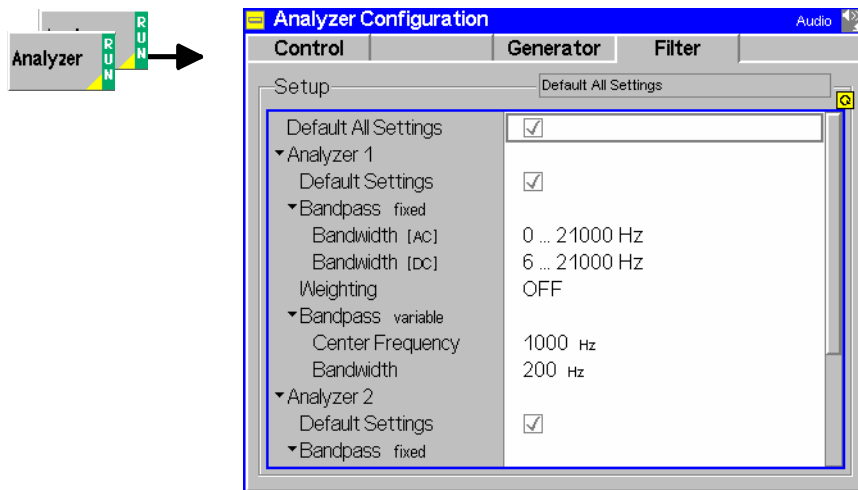

Fig. 4-41 Analyzer Configuration – Filter

Default Settings The *Default Settings* switch assigns default values to all settings in the *Filter* tab (the default values are quoted in the command description in chapter 6).

Remote Control
—

Bandpass The *Bandpass* section sets the bandwidth of the fixed band pass (see [Fig. 4-40 above](#)).

Bandwidth (AC Coup.) Bandwidth to be used if the AF path coupling is set to AC (see [Path Coupling](#) on page 4.103)

Bandwidth (DC Coup.) Bandwidth to be used if the AF path coupling is set to DC

The R&S CMU provides a broad selection of bandwidths with lower cutoff frequencies between 0 Hz and 300 Hz and upper cutoff frequencies between 250 Hz and 21 kHz (see command description in chapter 6).

Note: *If the AF Path Coupling is set to DC, the audio analyzer receives the complete AF input signal including a possible DC component. To avoid measurement inaccuracies, band pass filters with a lower cutoff ≥ 6 Hz are available only.*

Remote control

CONFigure:AFANalyzer:<Applic>:FILTer:BPASs:ACCoupling

CONFigure:AFANalyzer:<Applic>:FILTer:BPASs:DCCoupling

Weighting The *Weighting* section selects a weighting filter to be switched into the AF signal path after the fixed band pass (see [Fig. 4-40 above](#)).

Off No weighting filter

C-Message Switch on C-message weighted filter

CCITT Switch on CCITT weighting filter

A Switch on A-weighted filter

The A-weighted filter deemphasizes the very low and very high frequency components of the sound in a manner similar to the frequency response of the human ear and correlates well with subjective reactions to noise. Thus, noise levels stated in terms of dBA reflect the response of the human ear by filtering out some of the noise in the low- and high-frequency ranges that the ear does not detect well. The A-weighted scale commonly is used in local ordinances and standards.

Remote control

CONFigure:AFANalyzer:<Applic>:FILTer:WEIGhting

Bandpass (variable) The *Bandpass (variable)* section sets the center frequency and the bandwidth of the variable band pass.

Note: *The variable band pass settings affect the results for AC Voltage (Peak) 2 and AC Voltage (RMS) 2 only (see Fig. 4-40 above). These quantities are available in remote control but not displayed in the Analyzer/Generator menu.*

Remote control

CONFigure:AFANalyzer:<Applic>:FILTer:VBPass:CFRequency

CONFigure:AFANalyzer:<Applic>:FILTer:VBPass:BWIDth

Multitone Measurement

The graphical measurement menu *Multitone* shows the results of the multitone audio measurement.

To perform an *Multitone* measurement, the R&S CMU generates a composite audio signal that represents the superposition of up to 20 individual fixed-frequency tones with configurable frequency and level. An audio signal containing the same tones can be analyzed in a single measurement and displayed in a bar chart.

The *Multitone* measurement is thus a fast method to determine the level of up to 20 different tones at known frequencies and to perform a limit check for all results. Possible applications are also frequency response and intermodulation measurements.

The *Multitone* measurement menu is opened via the main menu *Menu Select* (with the associated key at the front of the instrument) or from the *Analyzer/Generator* menu using the *Multitone* hotkey. It provides three independent applications which can be started and stopped using the *AF Chan. One*, *AF Chan. Two*, or *Stereo* measurement control softkeys:

- In the *AF Chan. One* application, the AF generator signal is routed to the AF 1 OUT connector; the received audio signal is measured at *AF 1 IN*.
- In the *AF Chan. Two* application, the AF generator signal is routed to the AF 2 OUT connector; the received audio signal is measured at *AF 2 IN*.
- The *Stereo* application is a combination of the previous two applications, where the R&S generates and analyzes two independent multitone audio signals.

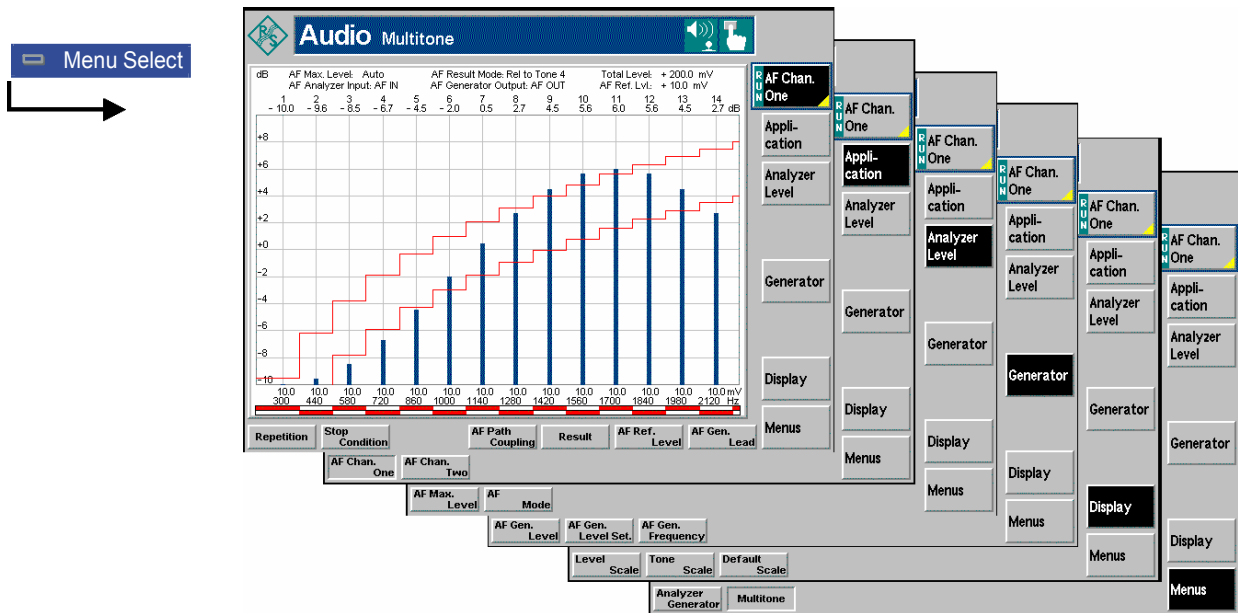

Fig. 4-42 Measurement menu Multitone

Test Settings

The *Multitone* measurement can be configured by means of the softkeys and hotkeys in the graphical measurement menu.

| | |
|--------------------------------------|--|
| AF Chan. One | <p>The <i>AF Chan. One</i> softkey controls the <i>Multitone</i> measurement and indicates its status (<i>RUN</i> <i>HLT</i> <i>OFF</i>). This status can be changed after softkey selection (pressing once) by means of the <i>ON/OFF</i> key or the <i>CONT/HALT</i> key.</p> <p><i>AF Chan. One</i> changes to <i>AF Chan. Two</i> or <i>Stereo</i> if the corresponding applications are selected.</p> <p>Remote control INITiate:MuLTitone:AFxChannel; ABORT:MuLTitone:AFxChannel; STOP:MuLTitone:AFxChannel; CONTINUE:MuLTitone:AFxChannel FETCh:MuLTitone:AFxChannel:STaTus? (x = 1,2)</p> |
| Measurement configuration | <p>Pressing the <i>AF Chan. One</i> softkey twice opens the popup menu <i>Multitone Configuration</i> (see page 4.112). Besides, a number of hotkeys defining the scope of the measurement and further settings are associated with the <i>AF Chan. One</i> softkey. All settings are also provided in the <i>Control</i> tab of the <i>Multitone Configuration</i> menu; see section Measurement Control (Multitone Configuration – Control) on page 4.112.</p> |
| Application | <p>The <i>Application</i> softkey activates one of the applications of the <i>Multitone</i> measurement. The two applications represent two independent audio circuits. Both circuits are identical except for the input and output connectors. Configurations such as the input path (<i>Analyzer Level</i>) can be set independently. Changing the application will also change the measurement control softkey <i>AF Chan. One</i> / <i>AF Chan. Two</i>.</p> |
| AF Chan. One | <p>The <i>AF Chan. One</i> hotkey selects the <i>Multitone</i> measurement on channel one. This means that the audio signals are applied to the connectors AF IN (R&S CMU input) and AF OUT (R&S CMU output) on the front panel.</p> <p>Remote control Audio channel no. one is identified by the third-level keyword AF1Channel.</p> |
| AF Chan. Two | <p>The <i>AF Chan. Two</i> hotkey selects the <i>Multitone</i> measurement on channel two. This means that the audio signals are applied to the connectors AUX 1 (R&S CMU input) and AUX 2 (R&S CMU output) on the R&S CMU front panel.</p> <p>Remote control Audio channel no. two is identified by the third-level keyword AF2Channel.</p> |
| Stereo | <p>If the <i>Stereo</i> application is active, the multitone analysis is performed twice at the <i>AF Chan. One</i> and <i>AF Chan. Two</i> frequencies.</p> <p>With the exception of the <i>Repetition Mode</i> and the <i>Stop Condition</i>, the <i>AF Chan One</i> and <i>AF Chan Two</i> settings are also valid for the <i>Stereo</i> application.</p> <p>Remote control The <i>Stereo</i> application is controlled with an independent set of ..MuLTitone:STEReo... commands. Many of the ..MuLTitone:STEReo... commands use a duplicated parameter set for simultaneous configuration of the two audio circuits. With the exception of the <i>Repetition Mode</i> and the <i>Stop Condition</i>, the <i>Stereo</i> settings overwrite the <i>AF Chan One</i> and <i>AF Chan Two</i> settings and vice versa.</p> |

Analyzer Level

The *Analyzer Level* softkey controls the level in the AF input signal path for both applications of the *Multitone* measurement.

AF Max. Level

The *AF Max. Level* hotkey sets the maximum expected input level in mV. Two independent values can be set for the two applications AF Chan. One (*Analyzer 1*) and AF Chan. Two (*Analyzer 2*). The setting is applied if the *AF Mode* (see softkey below) is set to *Manual*.

Note: *The AF Max. Level setting supersedes the corresponding level set in the Control tab of the Analyzer Configuration menu; see section [Measurement Control \(Analyzer Configuration – Control\)](#) on p. 4.102.*

The level is entered in mV.

```
[SENSE:]AFLEvel<Applic>:MAXimum <Level>
<Applic> = [:PRIMary] | :SECondary
```

AF Mode

The *AF Mode* hotkey determines how the input level is defined.

Manual Manual input via *AF Max. Level* hotkey

Auto Automatic setting according to the average power of the applied AF signal.

Two independent values can be set for the two applications AF Chan. One (*Analyzer 1*) and AF Chan. Two (*Analyzer 2*).

Note: *The AF Mode setting supersedes the corresponding setting in the Control tab of the Analyzer Configuration menu; see section [Measurement Control \(Analyzer Configuration – Control\)](#) on p. 4.102.*

Remote control

```
[SENSE:]AFLevel<Applic>:MODE MANual | AUTomatic
<Applic> = [:PRIMary] | :SECondary
```

Generator Level

The *Generator Level* softkey defines the level of the AF multitone signal.

The generator level settings are described in more detail in section [Test Tones \(Multitone Configuration – Tone Def.\)](#) on page 4.115.

Display

The *Display* softkey scales or shifts the graphical display.

Level Scale

The *Level Scale* hotkey defines the level scale of the *Multitone* test diagram (ordinate scale). The level scale merely represents a display configuration that doesn't have any impact on the measurement or on the input signal path.

The level scale is calculated from a maximum value (*Max.*) and a *Span*:

- The *Max* value defines the upper edge of the diagram.
- The difference *Max – Span* defines the lower edge of the diagram.
- The number of horizontal grid lines (corresponding to 10, 15, or 16 cells) and the ordinate labeling is adapted to the range.

Remote control

no remote control command; screen configuration only

| |
|---------------|
| Tone Scale |
|---------------|

The *Tone Scale* hotkey selects the display range (abscissa scale) of the test diagram. The range comprises 14 test tones which must be in consecutive order. This condition leaves the following options:

Tone 1 to 14 Display all results between tone 1 and tone 14

...

Tone 7 to 20 Display all results between tone 7 and tone 20

If a tone is within the selected range but disabled in the *Tone Def.* tab of the configuration menu (see section [Test Tones \(Multitone Configuration – Tone Def.\)](#) on page 4.115.), the corresponding result is not indicated, i.e. the bar is omitted and a gap occurs in the test diagram.

Remote control
no remote control command; screen configuration only

| |
|------------------|
| Default Scale |
|------------------|

The *Default Scale* hotkey cancels all display configurations made and activates the default settings.

Remote control
no remote control command; screen configuration only

| |
|-------|
| Menus |
|-------|

The *Menus* softkey displays the hotkey bar for switching over to the other measurement menus.

Measurement Results

The *Multitone* measurement menu displays the individual levels at up to 14 out of 20 different test tones, corresponding to 20 (not necessarily distinct) audio input frequencies. The results and the test settings are indicated in two parameter lines and the actual test diagram (bar graph) with its axis labels.

The measurement menus for the *AF Chan One* and *AF Chan Two* applications are analogous. If the *Stereo* application is active, the multitone analysis is performed twice at the *AF Chan. One* and *AF Chan. Two* frequencies. The two measurements are handled separately; the measurement diagram contains two bar graphs. The limit check is performed independently for the two sets of results.

Parameter lines
Test tone no. and
frequency response

Bar graph with upper
and lower limit lines

Test tone voltage
and frequency

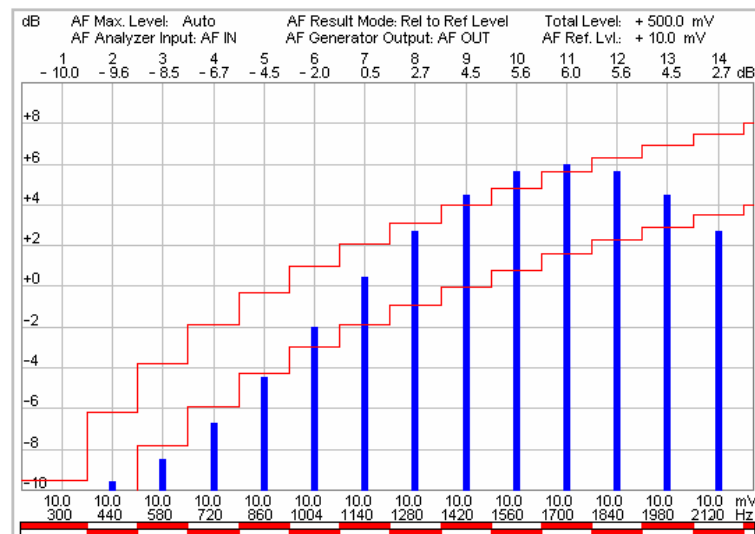

Fig. 4-43 Display of measurement results (Multitone)

Parameter lines The first parameter line contains the following settings and results:

| | |
|----------------|--|
| AF Max. Level | Maximum AF input level in mV as set by means of the <i>AF Max. Level</i> softkey described on p. 4.109. |
| AF Result Mode | Reference value for all levels as set in the configuration menu (see section <i>Measurement Control (Multitone Configuration – Control)</i> on p. 4.112) |
| Total Level | Sum of the individual levels of all test tones measured in mV. |

The second parameter line contains the following settings:

| | |
|---------------------|--|
| AF Analyzer Input | Input connector used for the Multitone measurement. In the AF Chan. One application, AF IN is used. |
| AF Generator Output | Output connector used for the Multitone measurement. In the AF Chan. One application, AF OUT is used. |
| AF Ref. Lvl | 0-dB line in the test diagram as set in the configuration menu (see section <i>Measurement Control (Multitone Configuration – Control)</i> on p. 4.112). |

Remote control
The settings are read out using the query corresponding to the setting command (setting command with appended question mark).

Bar graph The bar graph shows the AF level in dB at a maximum of 14 out of 20 different audio frequencies corresponding to a continuous range of test tones configured in the *Tone Def.* tab of the configuration menu (see p. 4.115). If a test tone is disabled in the configuration menu, the corresponding bar is omitted.

Frequency axis (abscissa) The range of test tones (no. 1 to 14, 2 to 15 etc.) to be viewed can be selected via the *Display – Tone Scale* hotkey (see p. 4.110). The bars representing the level of the different tones are equidistantly distributed over the whole diagram width. This optimizes the readability of the diagram but implies that the abscissa scale is not necessarily linear. Therefore, the frequency and voltage of every single test tone is displayed below the frequency axis.

Frequency response axis (ordinate) The ordinate can be arbitrarily scaled by setting a maximum and minimum value (both in dB). With a fixed ordinate, the adjustable 0 dB reference line (see *Level Scale* hotkey on p. 4.109) allows to shift the whole diagram vertically.

Remote control
 READ:ARRay:MULTitone:<Application>? etc.
 READ[:SCALar]:MULTitone:<Application>:TONE<nr>? etc.
 (<Application> = AF1Channel | AF2Channel | STEReo)

Limit Check The upper and lower limit lines for each test point defined in the *Limit Lines* tab of the configuration menu (see p. 4.114) correspond to the two red step functions in the diagram. If the result at a particular test point exceeds the upper limit (falls below the lower limit), the corresponding section of the upper (lower) bar across the bottom of the diagram turns red.

Remote control
 CALCulate:ARRay:MULTitone:<Application>:MATChing:LIMit?
 CALCulate[:SCALar]:MULTitone:<Application>:TONE<nr>:MATChing:
 LIMit?
 CALCulate[:SCALar]:MULTitone:<Application>:MATChing:LIMit?
 (<Application> = AF1Channel | AF2Channel | STEReo)

Measurement Configurations (Multitone Configuration)

The popup menu *Multitone Configuration* contains four tabs which determine the parameters of the *Multitone* measurement including the error tolerances.

The popup menu *Multitone Configuration* is activated by pressing the main softkey (labeled *AF Chan. One* or *AF Chan. Two*, depending of the application selected) in the measurement menu *Multitone* twice. It is possible to change between the tabs by pressing the associated hotkeys.

Measurement Control (Multitone Configuration – Control)

The *Control* tab controls the *Multitone* measurement by determining

- The Repetition mode
- The *Stop Condition* for the measurement
- The AC or DC input *Path Coupling*
- A settling time for the AF generator (*AF Generator Lead*)
- The 0-dB line in the graphical diagram (*AF Ref. Level*)
- Reference value for all levels in the graphical diagram (*Result*)

Besides, it configures the measurement diagram by adding or removing the *Grid*. All parameters can be set independently for the two AF channels 1 and 2.

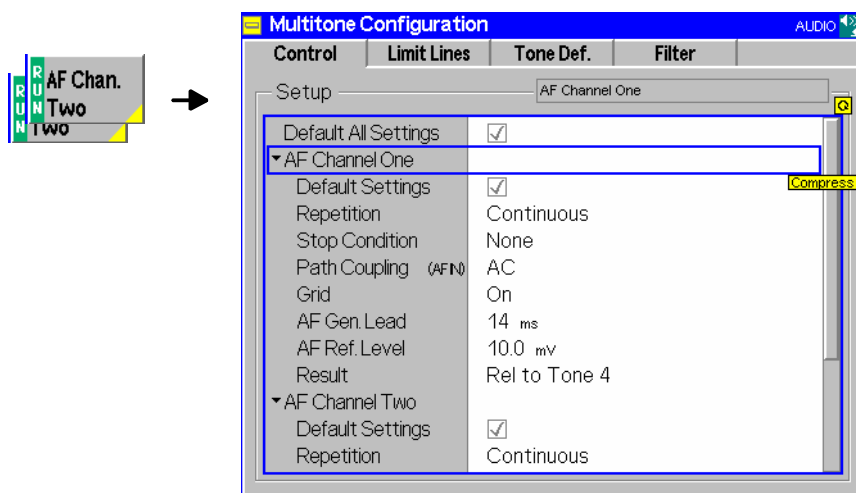

Fig. 4-44 Multitone Configuration – Control

Default Settings The *Default* switch assigns default values to all settings in the *Control* tab (the default values are quoted in the command description in chapter 6). Two additional default switches reset all *AF Channel One* or all *AF Channel Two* settings, respectively.

Remote Control: –

Repetition *Repetition* determines the repetition mode, see Chapter 3 of this manual and explanations given on page 4.53 for the *Power* measurement. In *Audio*, one statistics cycle is terminated when the system has settled and a valid result is available.

Remote control

```
CONFigure:MULTitone:<Application>:CONTRol:REPetition
  CONTinuous | SINGleshot | 1 ... 10000,NONE,<Stepmode>
  (<Application> = AF1Channel | AF2Channel | STEReo)
```

Stop Condition *Stop Condition* defines a stop condition for the measurement:

None Continue measurement even if tolerance is exceeded

On Limit Failure Stop measurement if tolerance is exceeded

Remote control

```
CONFigure:MULTitone:<Application>:CONTRol:REPetition
  CONTinuous | SINGleshot | 1 ... 10000,NONE,<Stepmode>
  (<Application> = AF1Channel | AF2Channel | STEReo)
```

AF Path Coupling *AF Path Coupling* sets the input path for measurement of the AC or AC and DC component of the AF signal:

AC DC component of the measured AF signal (including a possible DC offset of the input amplifier) blocked. This ensures accurate measurement of the AC component. The DC component, however, can not be measured; the DC Voltage output field in the Analyzer/Generator menu indicates "---".

DC Measurement of the complete AF input signal (DC plus AC components).

Note: *The AF path coupling has an impact on the allowed filter settings; see section [Input Path Configuration \(Multitone Configuration – Filter\)](#) on p. 4.117.*

Remote control

```
CONFigure:MULTitone:<Application>:COUPling AC | DC
  (<Application> = AF1Channel | AF2Channel | STEReo)
```

AF Generator Lead *AF Generator Lead* defines a settling time for the measurement to be applied after a change of the generator settings. A small value accelerates the measurement but may impair its accuracy.

Remote control

```
CONFigure:MULTitone:<Application>:AFGLead <Time>
  (<Application> = AF1Channel | AF2Channel | STEReo)
```

AF Ref. Level *AF Ref. Level* defines an audio reference level. The reference level defines the 0 dB line of the test diagram provided that *Relative to Ref. Lev.* is selected as *Result* (see below). The level is entered in mV.

Remote control

```
CONFigure:MULTitone:<Application>:RLEVel <Voltage>
  (<Application> = AF1Channel | AF2Channel | STEReo)
```

| | | |
|---------------|---|--|
| Result | The <i>Result</i> function defines the reference value for all measurement results. This corresponds to the 0 dB reference line in the diagram. | |
| | <i>Relative to Ref. Lev.</i> | All results are referenced to the AF Ref. Level; see above |
| | <i>Relative to Tone 1</i> | All results are referenced to the measurement result at tone 1 (if available) |
| | ... | |
| | <i>Relative to Tone 20</i> | All results are referenced to the measurement result at tone 20 (if available) |

The measurement is taken at up to 20 audio frequencies (tone 1 to 20) which can be defined and switched on or off in the *Tone Def.* tab of the configuration menu (see page 4.115).

Remote control

```
CONFigure:MULTitone:<Application>;RMODE RLEV | TON<nr>
  (<Application> = AF1Channel | AF2Channel | STEReo)
```

Limit Lines (Multitone Configuration – Limit Lines)

The *Limit Lines* tab defines upper and lower limits for the audio level at all test tones and enables or disables the limit check. All parameters can be set independently for the two AF channels 1 and 2.

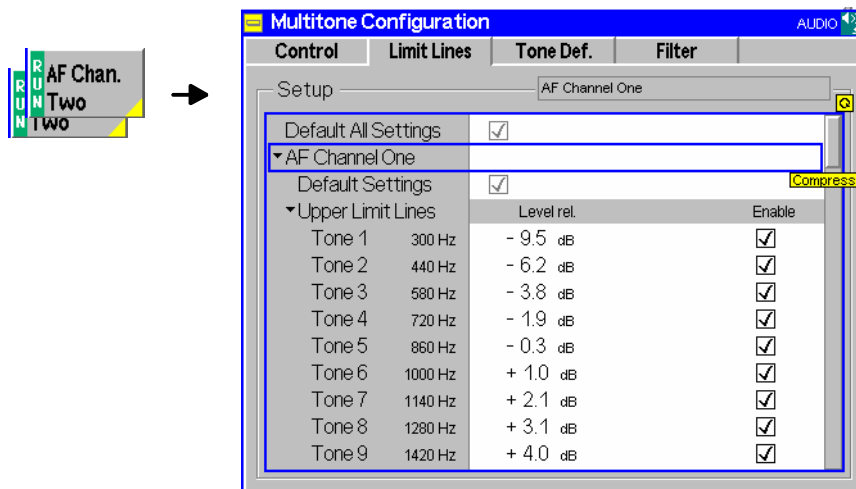

Fig. 4-45 Multitone Configuration – Limit Lines

Default Settings The *Default All Settings* switch assigns default values to all fields in the *Limit Lines* tab (the default values are quoted in the command description in chapter 6 of this manual). Two additional default switches reset all *AF Channel One* or all *AF Channel Two* settings, respectively.

Remote control

```
DEFault:MULTitone:LIMit:LINE ON | OFF
DEFault:MULTitone:<Application>;LIMit:LINE ON | OFF
  (<Application> = AF1Channel | AF2Channel | STEReo)
```

Upper Limit Line/ Lower Limit Line Upper and lower limit lines for all 20 test points can be defined separately in the two table sections *Upper Limit Line* and *Lower Limit Line*.

The tone nos. and the corresponding frequencies are indicated in the two left columns of the table as defined in the *Tone Def.* tab (see p. 4.115). For each tone, the upper and lower limit can be entered as a single value in dB. The corresponding *Enable* checkbox switches the limit line in the test diagram and the limit check on (if checked) or off.

Remote control

```

CONFigure:MULTitone:<Application>:LIMit:LINE:ASYMmetric:UPPer
    <Limit_1>, <Enable_1>...
CONFigure:MULTitone:<Application>:TONE<nr>:LIMit:LINE
    :ASYMmetric:UPPer <Limit>, <Enable>
CONFigure:MULTitone:<Application>:LIMit:LINE:ASYMmetric:LOWer
    <Limit_1>, <Enable_1>...
CONFigure:MULTitone:<Application>:TONE<nr>:LIMit:LINE
    :ASYMmetric:LOWer <Limit>, <Enable>
    (<Application> = AF1Channel | AF2Channel | STEReo)
  
```

Test Tones (Multitone Configuration – Tone Def.)

The *Tone Def.* tab configures the audio test signal generated by the R&S CMU. This signal is composed of up to 20 test tones with different frequencies and levels. All parameters can be set independently for the two AF channels 1 and 2.

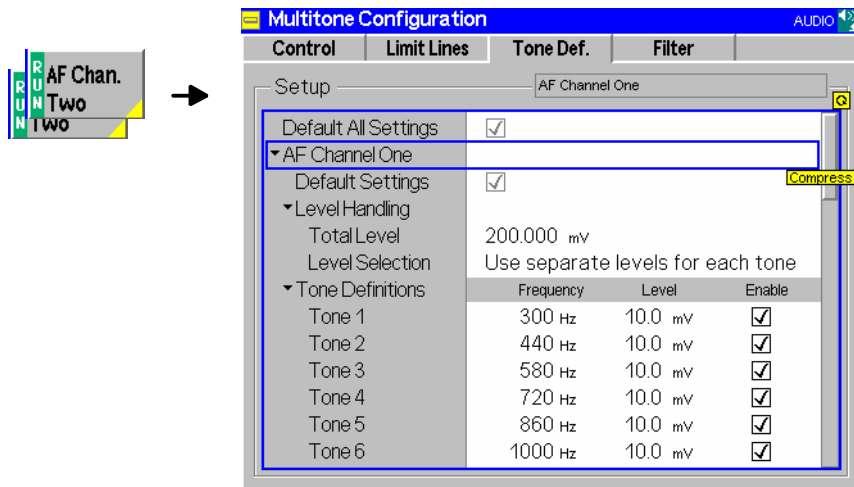

Fig. 4-46 Multitone Configuration – Tone Def.

Default Settings The *Default All Settings* switch assigns default values to all fields in the *Tone Def.* tab (the default values are quoted in the command description in chapter 6 of this manual). Two additional default switches reset all *AF Channel One* or all *AF Channel Two* settings, respectively.

Remote control

```

DEFault:MULTitone:FILTer ON | OFF
DEFault:MULTitone:<Application>:FILTer ON | OFF
    (<Application> = AF1Channel | AF2Channel | STEReo)
  
```

Level Handling: *Total Level* defines the sum of the individual voltages of all enabled tones. The meaning of the total level depends on the *Level Selection* setting (see below):

Total Level

- If *Level Selection* is set to *Use Separate Levels*, a separate AF level can be assigned to each of the 20 test tones.
- If *Level Selection* is set to *Use Total Level*, a single sum level is defined for the whole multitone signal. This level is evenly distributed among all enabled test tones.

The levels are entered in mV.

The *Total Level* entered must not exceed the maximum level of the AF generator quoted in the data sheet.

Remote control

```
CONFigure:MULTitone:<Application>:TDEFinition:TLEVel
(<Application> = AF1Channel | AF2Channel | STEReo)
```

Level Selection The *Level Selection* table section defines how the voltage of each of the test tones is determined:

Use separate levels for each tone

A separate AF level (in mV) can be assigned to each of the 20 test tones. The *Total Level* is ignored. It can still be edited for future measurements where the *Level Selection* parameter is set to *Manual*.

Use Total Level

A single sum level (also in mV) is defined for the whole multitone signal. This level is evenly distributed among all enabled test tones. This means that the level of each enabled test tone is set to $Total\ Level / n$ where n is the number of enabled test tones ($n = 1$ to 20). If a test tone is disabled, the total level is maintained and the share of the remaining test tones in the total level increases.

Remote control

```
CONFigure:MULTitone:<Application>:TDEFinition:MODE
SEParate | TLEVel
(<Application> = AF1Channel | AF2Channel | STEReo)
```

Tone Definitions The *Tone Definitions* table assigns an audio *Frequency* (in Hz) and *Level* (RMS voltage in mV) to each of the 20 test tones.

The frequencies must be multiples of 1 Hz. It is possible, however, to define several tones at the same frequency, or to number the tones in arbitrary order: The x-axis is scaled by the **number** of the test tones, not by their frequency. The RMS voltages of different tones may coincide and can vary within the range quoted in the remote control command description in chapter 6 of this manual. The sum of all test tones must not exceed the maximum level of the AF generator quoted in the data sheet.

The levels are entered in mV.

Note: *The voltages of all test tones enabled can be set manually or automatically, depending on the setting of the Level Selection parameter described above.*

The *AF Gen.* checkbox switches the tone in the audio signal and the corresponding bar in the test diagram on (if checked) or off.

Remote control

```
CONFigure:MULTitone:<Application>:TDEFinition
<Freq_1>,<Level_1>,<Enable_1>,...
```



```

CONFigure:MULTitone:<Application>:TDEFinition:TONE<nr>
    <Freq>,<Level>,<Enable>,...
    (<Application> = AF1Channel | AF2Channel | STEReo)
    
```

Input Path Configuration (Multitone Configuration – Filter)

The *Filter* tab configures the receive path of the R&S CMU for the *Multitone* measurement (see Fig. 4-47 below). All parameters can be set independently for the two AF channels 1 and 2.

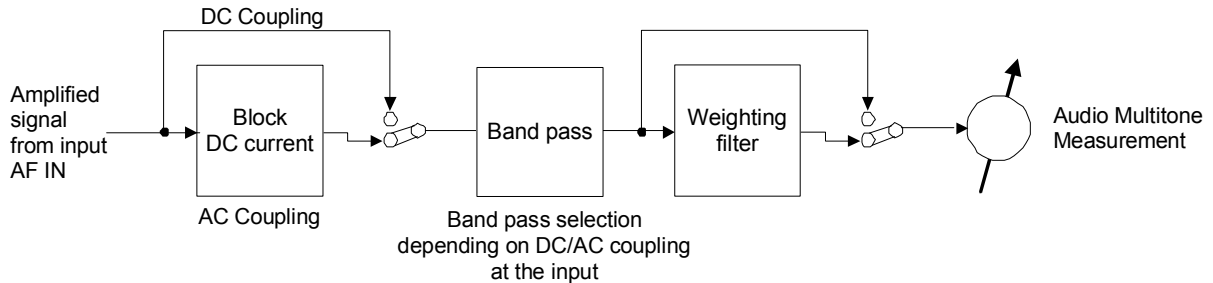

Fig. 4-47 Signal path for Multitone measurements

The audio receive path of the R&S CMU may contain the following filter stages:

- AF Path Coupling** Capacitor stage to block the DC component of the AF input signal including a possible DC offset of the input amplifier. With DC coupling, the complete AF input signal is measured.
- Weighting** Weighting filter according to CCITT or C-message weighted filter.
- Band Pass** Audio band pass filter with selectable bandwidth to limit the input frequencies to a definite audio band and eliminate unwanted signal components. The allowed bandwidth depends on the *AF Path Coupling*.

The audio results are generated at the end of the audio receive path, after the audio signal has passed all filter stages that are switched on.

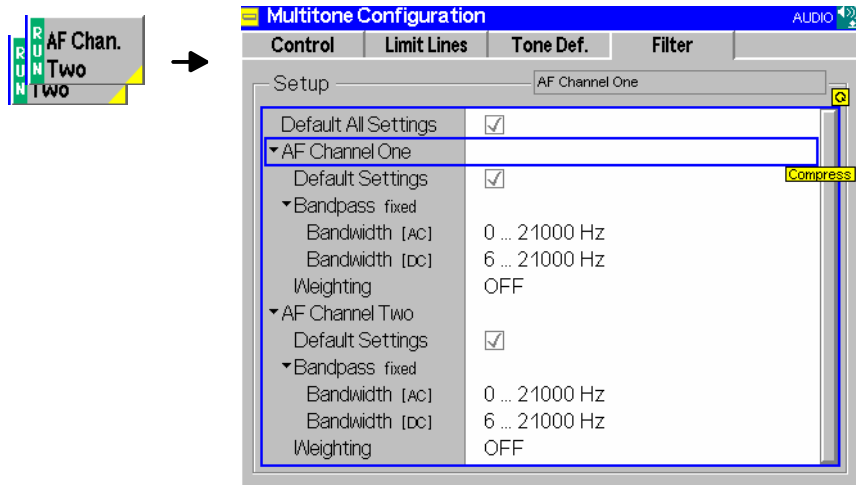

Fig. 4-48 Multitone Configuration – Filter

Default All Settings The *Default All Settings* switch assigns default values to all fields in the *Filter* tab (the default values are quoted in the command description in chapter 6). Two additional default switches reset all *AF Channel One* or all *AF Channel Two* settings, respectively.

Remote control

```
Default:MULTitone:FILTER ON | OFF
Default:MULTitone:<Application>:FILTER ON | OFF
(<Application> = AF1Channel | AF2Channel | STEReo)
```

AF Channel One The table section *AF Channel One* defines the input path for the *Multitone* measurement. The following settings are provided:

Band pass Selection of the bandwidth of the R&S CMU's audio band pass. A separate band pass can be selected for AC coupling and DC coupling.

Weighting Use of an A-weighted filter, a C-message weighted filter (*C-Message*), a *CCITT* weighting filter or none of these filters (*OFF*).

The R&S CMU provides a broad selection of bandwidths with lower cutoff frequencies between 0 Hz and 300 Hz and upper cutoff frequencies between 250 Hz and 21 kHz (see command description in chapter 6).

Note: *If the AF Path Coupling is set to DC (see section [Measurement Control \(Multitone Configuration – Control\)](#) on page 4.112), the audio analyzer receives the complete AF input signal including a possible DC component. To avoid measurement inaccuracies, a band pass with a lower cutoff ≥ 6 Hz must be used.*

Remote control

```
CONFigure:MULTitone:<Application>:FILTER:BPASs:DCCoupling
<Bandwidth>
CONFigure:MULTitone:<Application>:FILTER:BPASs:ACCoupling
<Bandwidth>
CONFigure:MULTitone:<Application>:FILTER:BPASs:WEIGHTing
CME | CCI | OFF
(<Application> = AF1Channel | AF2Channel | STEReo)
```

Total Harmonic Distortion (THD)

The Total Harmonic Distortion (*THD*) application provides a single-frequency audio test signal with adjustable power and very low harmonic distortion and measures the AF power at the generator frequency (1st harmonic labeled d1) and at the 2nd, 3rd ... 9th harmonics. These results yield the Total Harmonic Distortion, defined as the ratio of the summed up power of the 2nd, 3rd ... 9th harmonics to the power of all harmonics including the fundamental signal.

The THD is obtained in a frequency-selective measurement at the harmonic frequencies. The measurement is accessed from the *Menu Select* menu. It provides three independent applications which can be started and stopped using the *AF Chan. One*, *AF Chan. Two*, or *Stereo* measurement control softkeys:

- In the *AF Chan. One* application, the AF generator signal is routed to the AF 1 OUT connector; the received audio signal is measured at AF 1 IN.
- In the *AF Chan. Two* application, the AF generator signal is routed to the AF 2 OUT connector; the received audio signal is measured at AF 2 IN.
- The *Stereo* application is a combination of the previous two applications, where the R&S generates and analyzes two audio signals at equal or different frequencies.

In the standard test setup for the, the AF generator signal is fed to the input of a DUT, and the R&S CMU measures the harmonic distortion caused by the DUT's nonlinear behavior. When using an external test signal, ensure that it is sufficiently free from distortion.

The *Stereo* application is primarily suited for THD tests on devices with a stereo audio output.

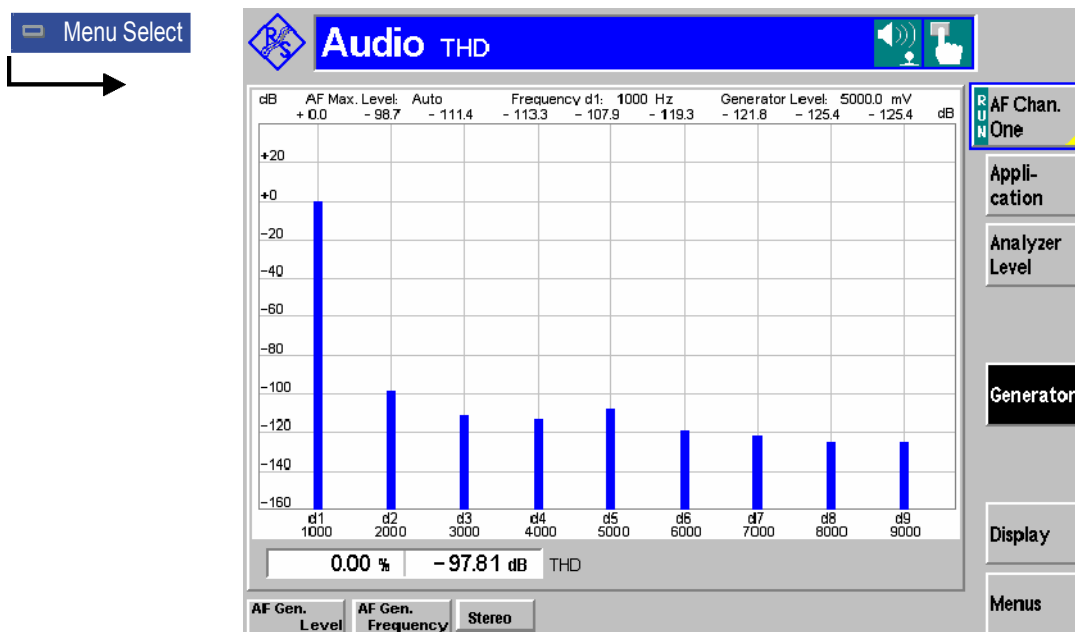

Fig. 49 Display of results (Audio – THD)

Test Settings

The softkeys and associated hotkeys provide the most important test settings. They are analogous to the other *Audio* measurements; see section [Test Settings](#) on p. 4.97. The *THD Configuration* menu is described on p. 4.120.

Measurement Results

The diagram in the *Audio – THD* menu shows the levels of the 1st harmonic d1 and of the harmonics d2 ... d9 in dB. The 1st harmonic provides the 0-dB level reference. By definition, the frequency of the nth harmonic is equal to n times the d1 frequency. The diagram scale can be changed using the *Display – Level Scale* hotkey.

Below the diagram, the THD is displayed as a percentage and as a dB-value. The

percentage value is calculated from the ratio of the summed up power of the 2nd, 3rd ... 9th harmonics to the power of all harmonics including the fundamental signal:

$$THD[\%] = \sqrt{\frac{U^2_{d2} + U^2_{d3} + \dots + U^2_{d9}}{U^2_{d1} + U^2_{d2} + U^2_{d3} + \dots + U^2_{d9}}} \cdot 100 \%$$

The dB result is calculated according to:

$$THD[dB] = 20 \cdot \log(THD[\%])$$

The THD value never exceeds 100 % or 0 dB; its value is always smaller than the Total Harmonic Distortion and Noise (*THD + N*) provided in the audio *Analyzer/Generator* measurement. Harmonics at frequencies above 21 kHz are not evaluated and do not contribute to the THD. Moreover it is possible to exclude one or more harmonics from the THD calculation; see [Measurement Control \(THD Configuration – Control\)](#) on p. 4.120.

Stereo application

If the *Stereo* application is active, the THD analysis is performed twice at the *AF Chan. One* and *AF Chan. Two* frequencies. The two measurements are handled separately so that the formulas above hold for each measurement. The measurement diagram contains two bar graphs and two pairs of THD results.

Remote control

```
READ[:SCALar]:THD:AF1Channel:THD?
FETCh[:SCALar]:THD:AF1Channel:THD?
READ:ARRay:THD:AF1Channel?
FETCh:ARRay:THD:AF1Channel? (similar for AF2Channel and Stereo)
```

Measurement Configurations

The popup menu *THD Configuration* contains two tabs which determine the parameters of the *THD* measurement.

The popup menu *THD Configuration* is activated by pressing the main softkey (labeled *AF Chan. One* or *AF Chan. Two* or *Stereo*, depending of the application selected) in the measurement menu *THD* twice. It is possible to change between the tabs by pressing the associated hotkeys.

Measurement Control (THD Configuration – Control)

The *Control* tab of the configuration menu provide statistical settings and controls the generated and measured signals.

The two applications *AF Chan. One* or *AF Chan. Two* provide two completely independent sets of measurement settings.

Note: *With the exception of the Repetition Mode, the AF Chan One and AF Chan Two settings are also valid for the Stereo application. In remote control, the Stereo application provides additional commands for simultaneous configuration of the AF Chan One and AF Chan Two settings.*

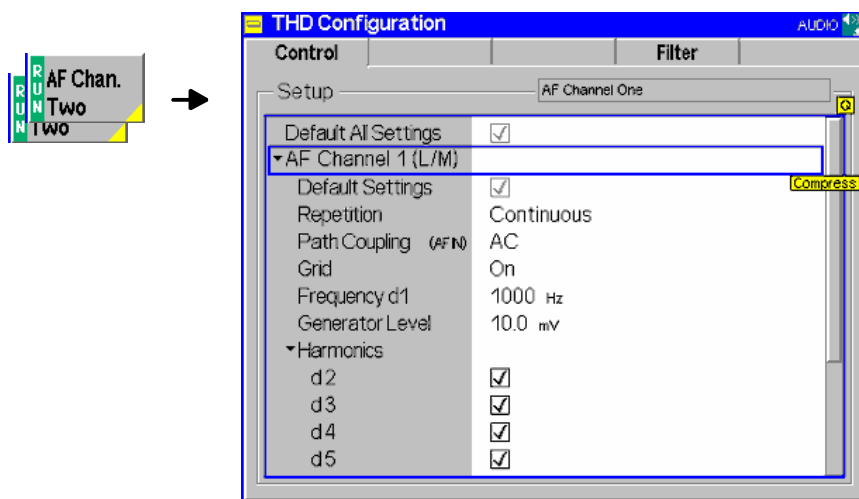

Fig. 50 THD Configuration – Control

| | | |
|---------------------|------------------------|---|
| AF Channel 1 | <i>Repetition</i> | Single shot or continuous THD measurement. In <i>Audio</i> , one statistics cycle is terminated when the system has settled and valid results are available. |
| | <i>Path Coupling</i> | Sets the input path for measurement of the AC or AC and DC component of the AF signal. If AC is set, the DC component of the measured AF signal (including a possible DC offset of the input amplifier) is blocked. This ensures an accurate measurement of the AC component. The DC component, however, cannot be measured and has no impact on the THD results. If DC is set, the complete AF input signal (DC plus AC components) is measured. |
| | Note: | The AF path coupling has an impact on the allowed filter settings; see section Input Path Configuration (Multitone Configuration – Filter) on p. 4.117. |
| | <i>Grid</i> | Displays or removes the grid in the diagram |
| | <i>Frequency d1</i> | Frequency of the audio generator and of the first harmonics d1 |
| | <i>Generator Level</i> | RMS level of the generated first harmonic. The level is entered in mV. |
| | <i>Harmonics</i> | List of harmonics d2 to d9. Unchecked harmonics are measured and displayed in the diagram, however, they are not included in the calculation of the THD. Harmonics at frequencies above 21 kHz are not measured. |

Remote control
 CONFigure:THD:AF1Channel:CONTrol:REPetition
 CONFigure:THD:AF1Channel:COUPling AC | DC
 CONFigure:THD:AF1Channel:TDEFinition
 CONFigure:THD:AF1Channel:HARMonics<nr>
 (similar for AF2Channel and STEReo)

Input Path Configuration (THD Configuration – Filter)

The *Filter* tab configures the receive path of the R&S CMU for the *THD* measurement. All parameters can be set independently for the two AF channels 1 and 2. The settings are also valid for the *Stereo* application.

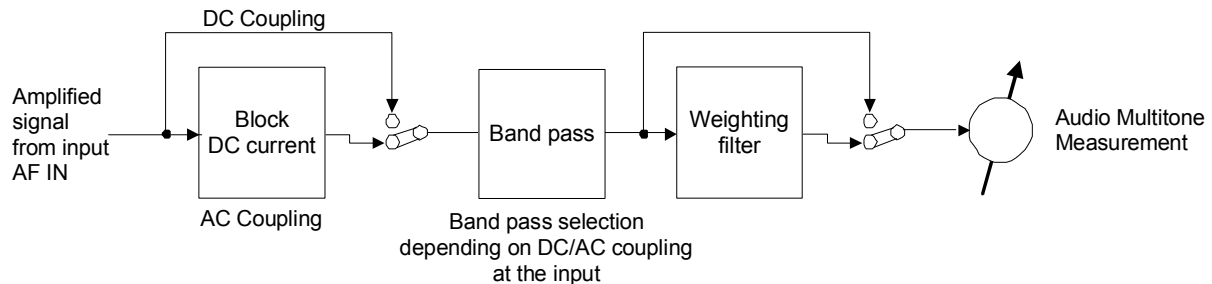

Fig. 51 Signal path for THD measurements

The audio receive path of the R&S CMU may contain the following filter stages:

AF Path Coupling Capacitor stage to block the DC component of the AF input signal including a possible DC offset of the input amplifier. With DC coupling, the complete AF input signal is measured.

Weighting Weighting filter according to CCITT or C-message weighted filter.

Band Pass Audio band pass filter with selectable bandwidth to limit the input frequencies to a definite audio band and eliminate unwanted signal components. The allowed bandwidth depends on the *AF Path Coupling*.

The audio results are generated at the end of the audio receive path, after the audio signal has passed all filter stages that are switched on.

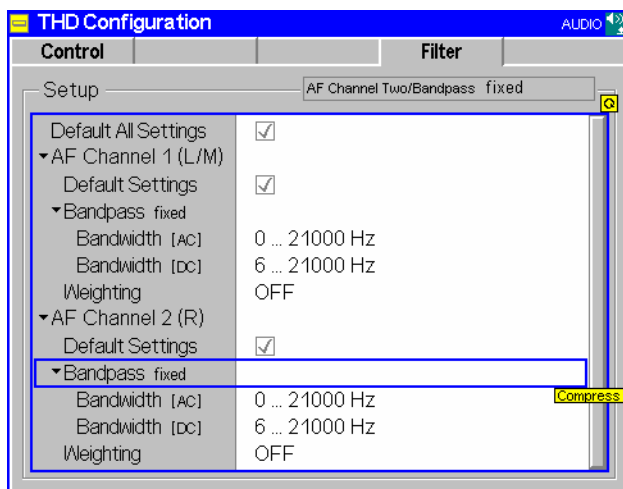

Fig. 52 THD Configuration – Filter

Default All Settings

The *Default All Settings* switch assigns default values to all fields in the *Filter* tab (the default values are quoted in the command description in chapter 6). Two additional default switches reset all *AF Channel One* or all *AF Channel Two* settings, respectively.

Remote control

Default:THD:FILTer ON | OFF

Default:THD:AFxChannel:FILTer ON | OFF (x = 1,2)

AF Channel One The table section *AF Channel One* defines the input path for the *THD* measurement. The following settings are provided:

Band pass Selection of the bandwidth of the R&S CMU's audio band pass. A separate band pass can be selected for AC coupling and DC coupling.

Weighting Use of an A-weighted filter, a C-message weighted filter (*C-Message*), a *CCITT* weighting filter or none of these filters (*OFF*).

The R&S CMU provides a broad selection of bandwidths with lower cutoff frequencies between 0 Hz and 300 Hz and upper cutoff frequencies between 250 Hz and 21 kHz (see command description in chapter 6).

Note: *If the AF Path Coupling is set to DC (see section [Measurement Control \(Multitone Configuration – Control\)](#) on page 4.112), the audio analyzer receives the complete AF input signal including a possible DC component. To avoid measurement inaccuracies, a band pass with a lower cutoff ≥ 6 Hz must be used.*

Remote control

```
CONFigure:THD:AFxChannel:FILTer:BPASs:DCCoupling
    <Bandwidth>
```

```
CONFigure:THD:AFxChannel:FILTer:BPASs:ACCoupling
    <Bandwidth>
```

```
CONFigure:THD:AFxChannel:FILTer:BPASs:WEIGHTing
    CME | CCI | OFF (x = 1,2)
```

The *Stereo* application is configured using the *AFxChannel* commands.

I/Q and IF Interface (Option CMU-B17)

Option CMU-B17 provides separate access to the I/Q and IF signals in the CMU200 receiver (RX) and transmitter (TX) paths. The functionality is applicable in conjunction with the *RF* function group (see section *I/Q-IF Interface (Connection Control – I/Q-IF)* on p. 4.94) and with a wide range of network options in *Signalling* as well as in *Non Signalling* test modes (see separate manuals for network options). The insertion of option CMU-B17 in bypass mode does not cause any influence on signals; i.e. the additional insertion loss caused by option CMU-B17 will be corrected during the mandatory calibration procedure after installation.

Block diagram The diagram below shows the possible signal paths and the input and output connectors related to option CMU-B17. The position of the connectors on the rear panel is shown in Chapter 1; for the technical specifications and the pin assignment refer to Chapter 8.

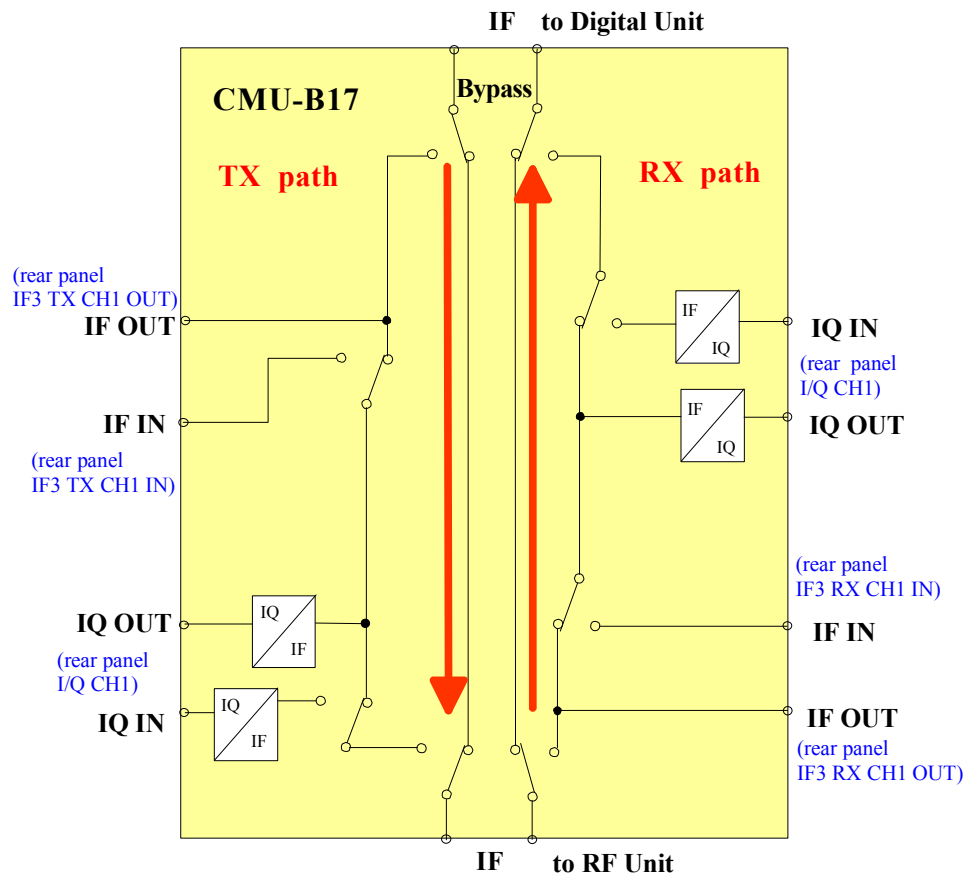

Fig. 4-53 I/Q-IF Interface

I/Q-IF Test Scenarios

A short overview of test scenarios with the necessary RX and TX path settings is given in *Table 4-3* on p. 4.95. The following examples illustrate the functionality in more detail.

The list of scenarios is not necessarily complete: Depending on the application, it is possible to define customized, *User defined* test scenarios.

1. Default setting: Bypass mode for RF tests with maximum accuracy

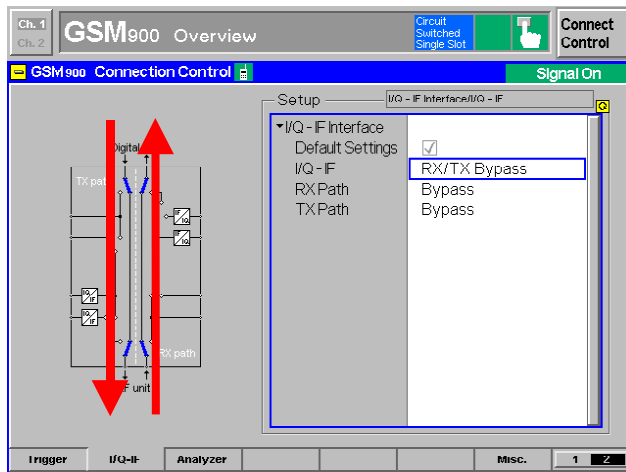

- The path loss due to the inserted board CMU-B17 will be corrected automatically during the mandatory calibration procedure after installation of the option.
- The option has no influence on transmitted and received signals.

2. Scenarios for I/Q-IF signal monitoring

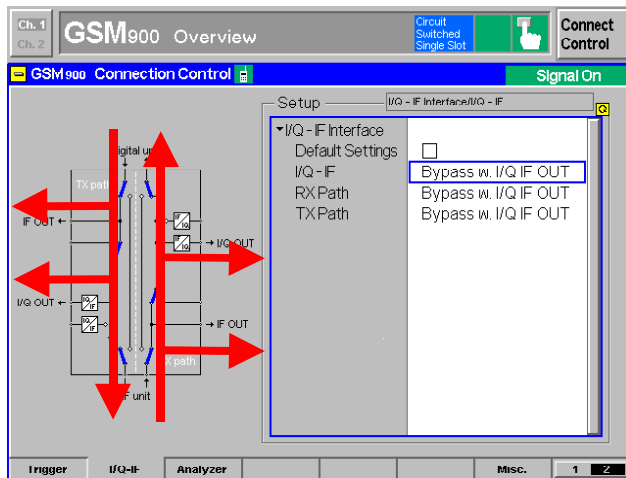

- Monitoring of uplink and downlink signals via IF or I/Q outputs possible.
- The insertion loss of option CMU-B17 will be corrected during the calibration procedure.
- This mode can be used for fading applications.

3. Interruption of I/Q or IF signal paths for external signal processing

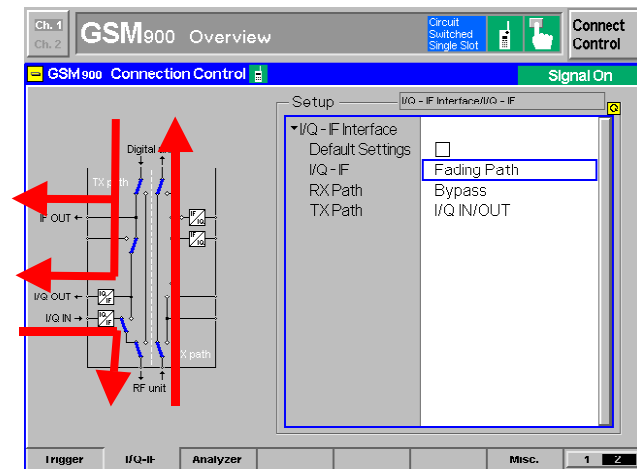

Fading Path scenario:

- The *Fading Path* scenario can be used for connecting an external baseband-fading simulator (pls. see next chapter, CMU200 and ABFS).
- The transmitted signal can be routed to the fading simulator via IF or IQ outputs.
- Additionally it is possible to return the faded signal via IQ input.

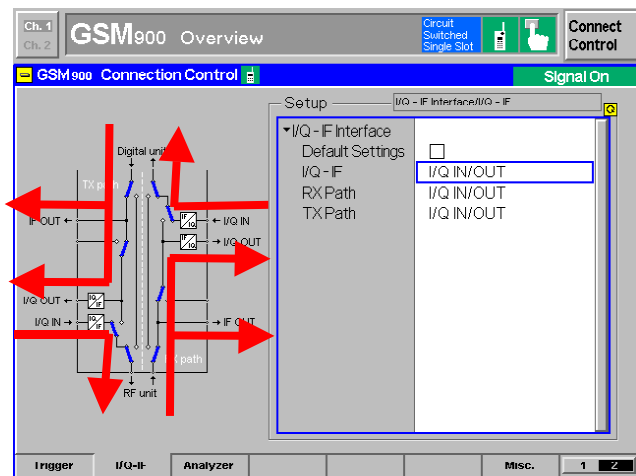

I/Q IN/OUT scenario

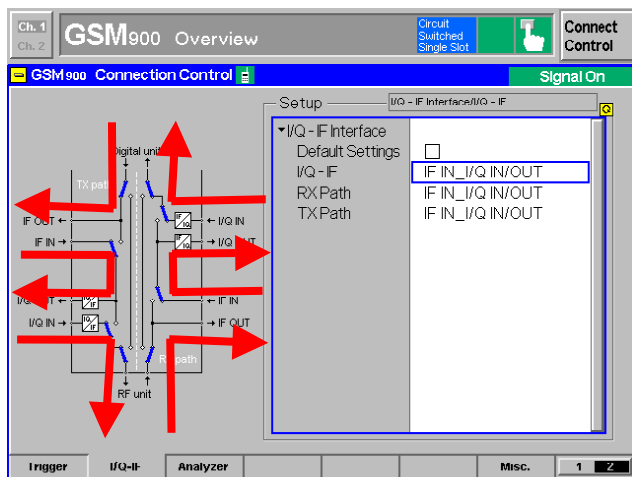

IF IN_I/Q IN/OUT scenario

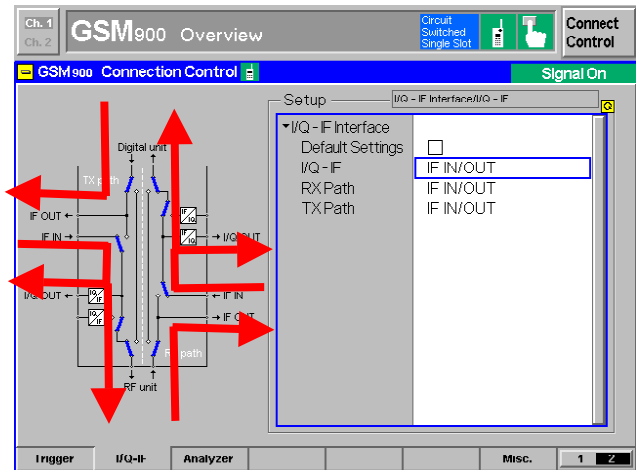

IF IN/OUT scenario

Application Examples

The following section is intended as a short introduction to possible applications of option CMU-B17. For detailed information refer to the relevant application notes.

Bit Error Rate Measurements on Digital Receivers under Fading Conditions

1. CMU 200 / CMU-B17 in combination with SMIQ / SMIQ-B14

IQ/IF scenario: *Fading Path or Bypass w. I/Q IF OUT*

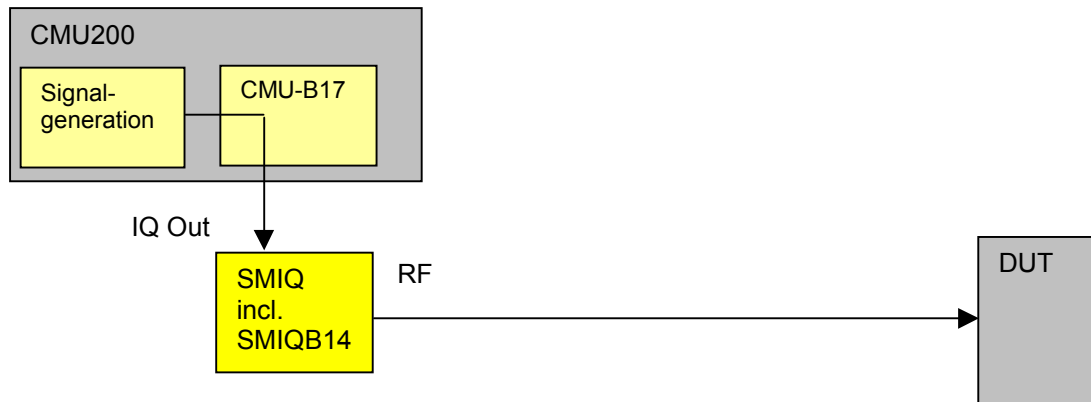

IQ/IF scenario: *Bypass w. I/Q IF OUT*

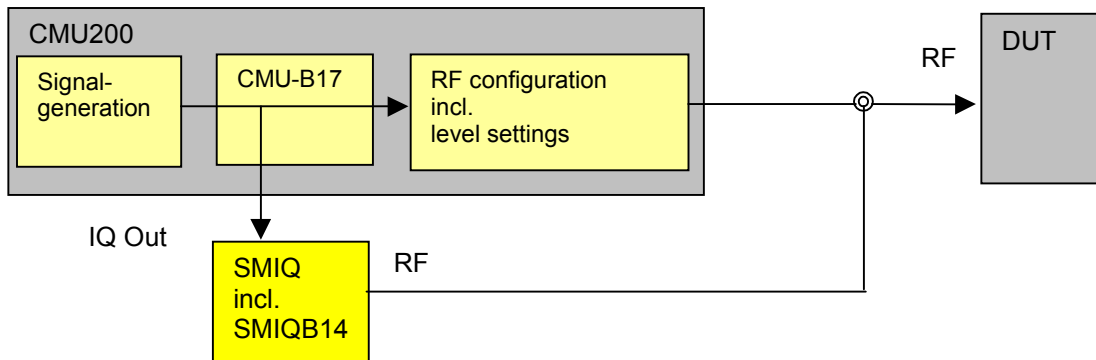

The CMU incl. option CMU-B17 in combination with R&S signal generator SMIQ incl. IQ fading simulator option SMIQB14 can be used for receiver Bit Error Rate tests under fading conditions. The IQ output of CMU-B17 transmitter (TX) path feeds the signal into SMIQ's IQ input. The SMIQ forwards the faded RF signal directly to the receiver (RX) of the DUT. The illustrated test setups depend on the test scenario selected on option CMU-B17.

For more information please refer to R&S application note 1MA07_0E: *SMIQ as Fading Simulator for External Signals*.

2. CMU 200 / CMU-B17 in combination with fading simulator ABFS

IQ/IF scenario: *Fading Path*

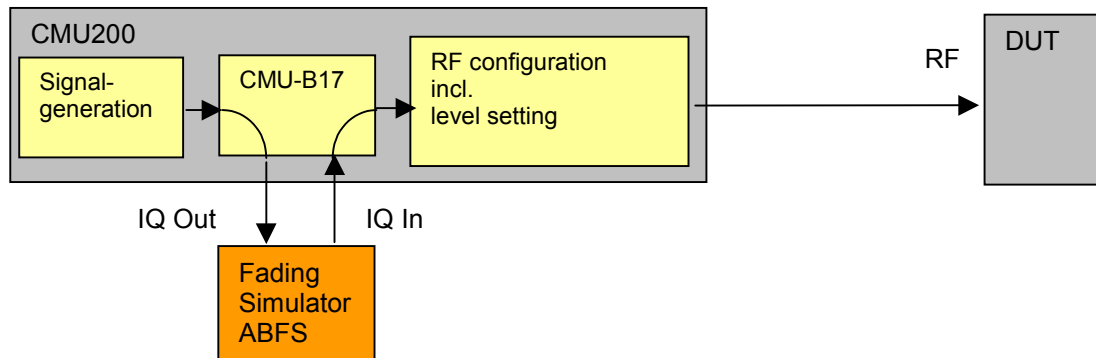

The CMU 200 incl. option CMU-B17 can be used in combination with the IQ fading simulator R&S ABFS for receiver tests under fading conditions. In this case the signal is routed to the DUT via the CMU's RF interface.

Additional information for GSM:

To avoid unwanted influences on the fading profile it is highly recommended:

- To set all timeslots to the same level.
- To configure the TX signal of the CMU with the same RF frequencies and RF levels for both TCH and BCCH.
- To switch hopping off.

CMU200 as I/Q Generator and RF Analyzer

Another important application is the generation of IQ signals meeting the relevant standards. It is possible to generate complex signals that may even originate from a real signalling sequence. Most mobile radio chipsets comprise an RF chip and a baseband chip that communicate with each other via an analog IQ interface. The CMU-B17 IQ-interface can then be used to access the two chips. In mobile radio development, different teams are often required for this purpose and the new testing feature via the IQ interfaces allows development work to be divided in space and time.

IQ/IF scenario: *Bypass w. I/Q IF OUT*

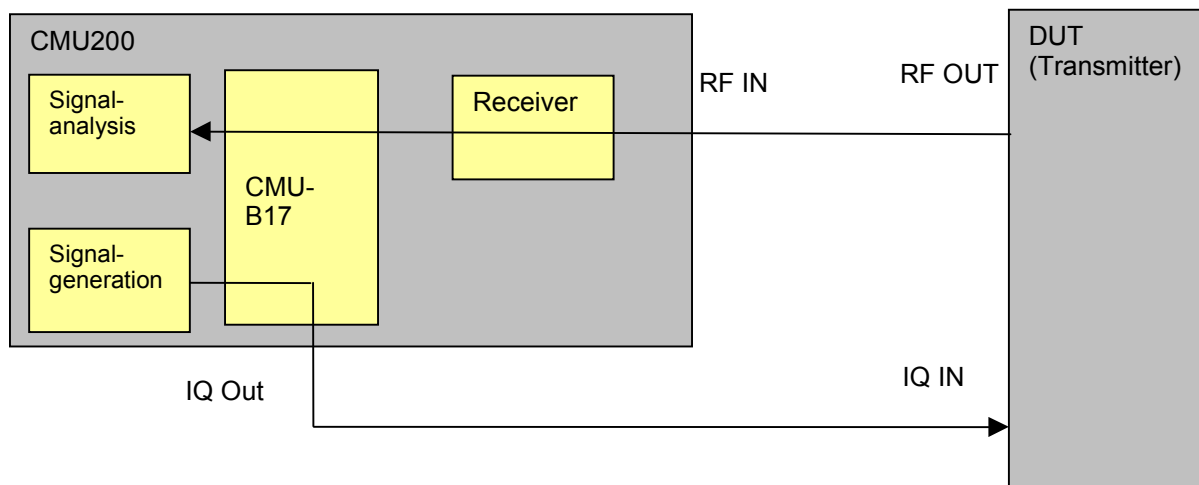

CMU200 as RF Generator and I/Q Analyzer

If IQ signals are applied to the receive section of the tester, signal analysis can be performed in the same manner as when analyzing an RF signal. In this test setup, a modulation analysis is useful since it assesses the quality of an IQ signal. The modulation analysis measures quantities such as the I/Q offset and I/Q imbalance, which are directly related to the I/Q signals. In addition, it provides more complex evaluations such as the error vector magnitude (EVM).

IQ/IF scenario: User defined: RX Path: I/Q IN/OUT TX Path: Bypass

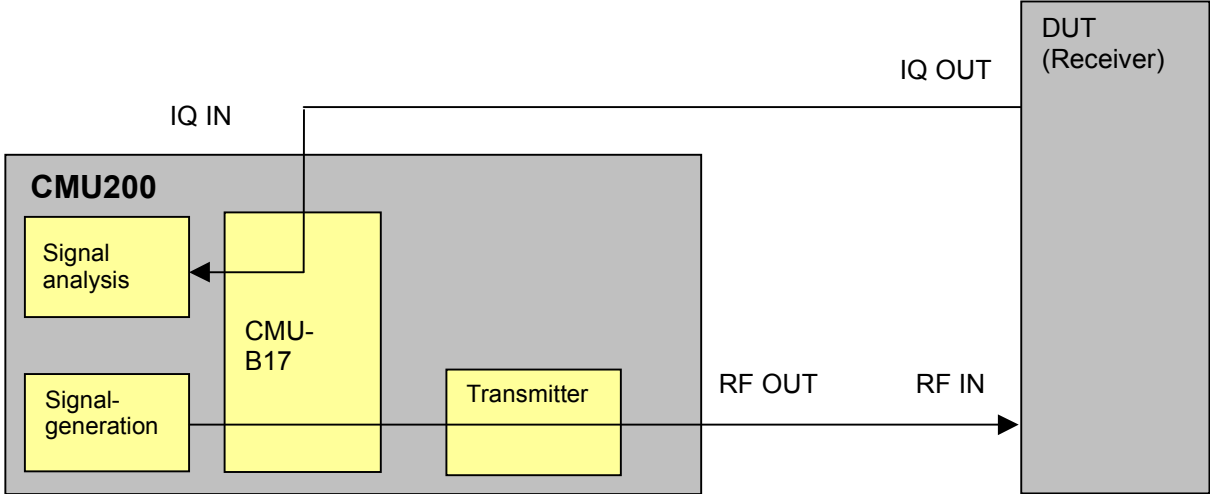

FM Stereo Transmitter (Option R&S® CMU-K14)

With option R&S® CMU-K14, the R&S® CMU 200 can generate a single-tone FM MPX stereo signal. The signal conforms to the specification in the ITU- R BS.450-2 recommendation, *Transmission Standards for FM Sound Broadcasting at VHF*, and is intended as a test signal for FM stereo receiver tests. In particular, the R&S CMU can generate normal (mono) signals and left or right channel signals separately.

The principle of a stereo transmitter is shown in Fig. 4-54 below. To simplify the picture, filter stages are omitted. The MPX stereo signal consists of three parts:

1. The normal (mono) audio signal is built up of the sum of the left and right channels: $M = (L + R) / 2$. This signal is directly fed to the FM modulator.
2. In addition a difference signal $S = (L - R) / 2$ is generated and used to modulate a 38 kHz subcarrier using Double Sideband Suppressed Carrier (DSSC) modulation. DSSC is an AM modulation of the subcarrier.
3. To keep the receiver decoder locked into the 38 kHz subcarrier, a 19 kHz pilot tone (1/2 of 38 kHz) is transmitted as well.

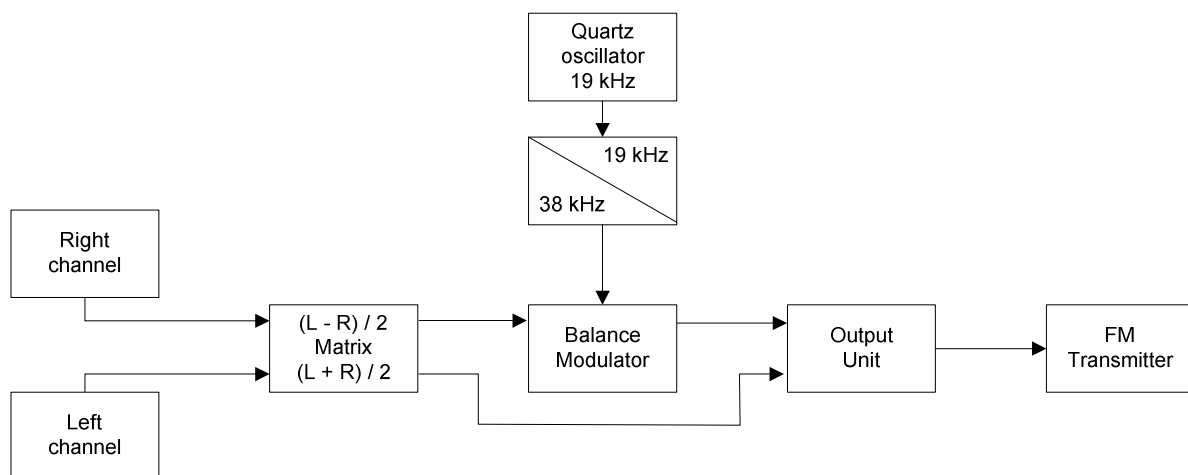

Fig. 4-54 Principle of the FM stereo coder

The FM stereo decoder can separate the three signal contributions using appropriate filter stages, add the $(L + R) / 2$ and $(L - R) / 2$ signals for the left channel $((L + R) / 2 + (L - R) / 2 = L)$ and subtract them for the right channel $((L + R) / 2 - (L - R) / 2 = R)$.

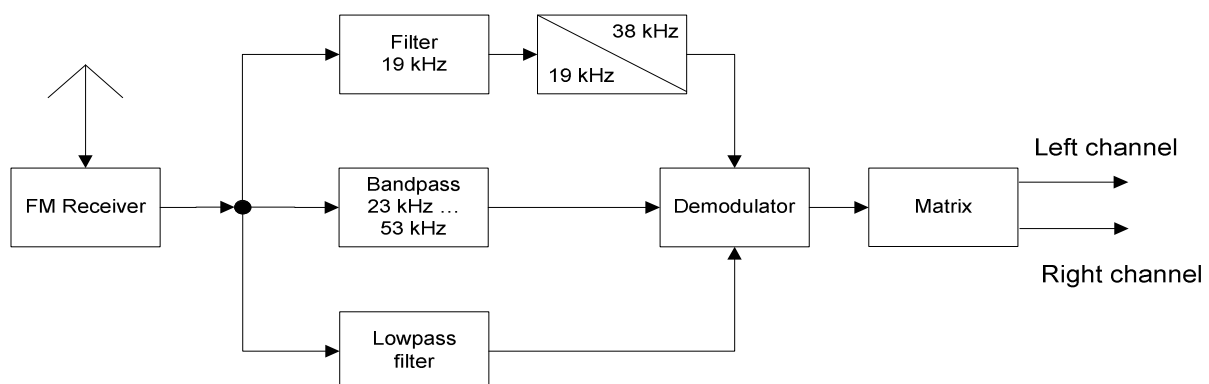

Fig. 4-55 Principle of the FM stereo decoder

The complete spectrum of the FM stereo signal is shown below.

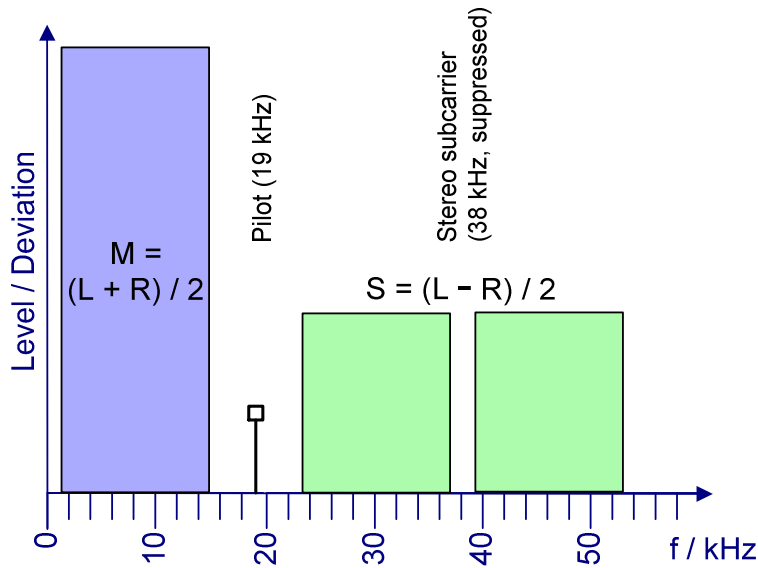

Fig. 4-56 Spectrum of the stereo MPX signal

The stereo transmitter mode is selected and configured in the *Generator* tab of the *Connection Control* menu. Alternatively, the settings are accessible from the measurement menus (*Generator – FM Stereo Pilot* and *Generator – FM Stereo Audio* hotkeys).

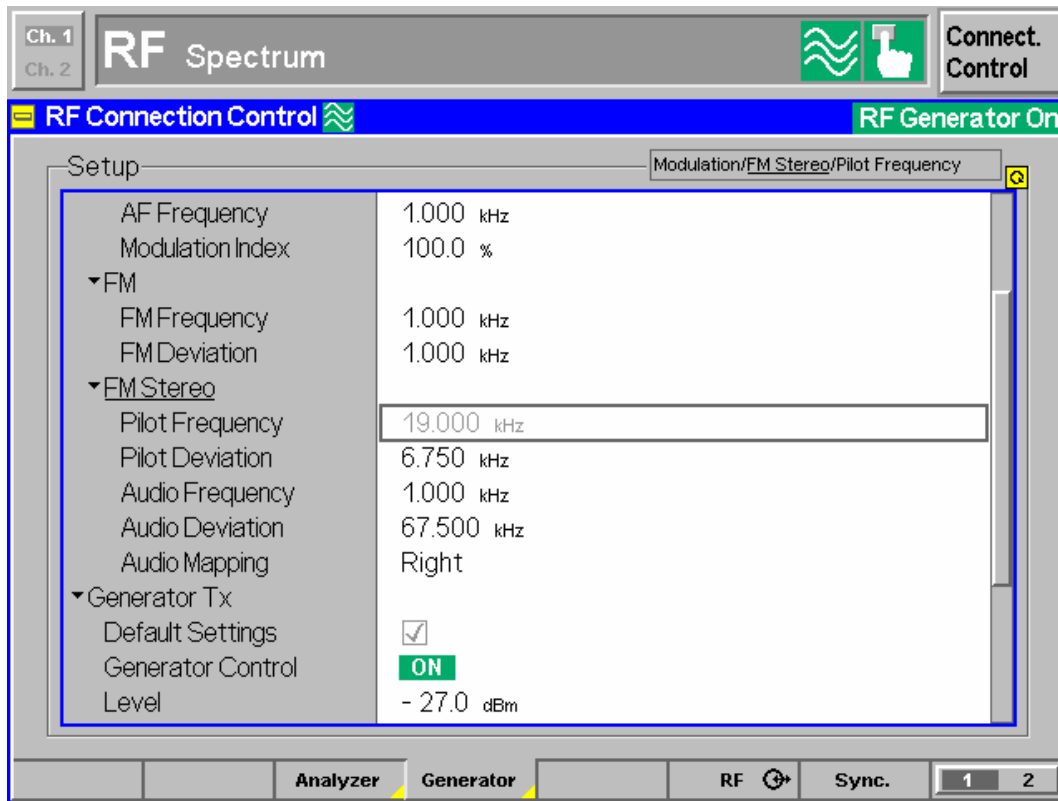

Fig. 4-57 Generator – FM Stereo configuration

| | | |
|--------------------------|--|--|
| Modulation – Mode | <i>Off</i> | Unmodulated (CW) RF carrier signal |
| | <i>SSB</i> | Single side band or single sideband suppressed carrier modulation; transmission of the upper sideband without the carrier. The RF carrier is shifted by a constant AF offset frequency defined with the <i>AF Frequency</i> softkey. |
| | <i>DSB</i> | Double sideband or double sideband suppressed carrier (DSSC) modulation; transmission of both sidebands without the carrier. |
| | <i>AM</i> | RF carrier is amplitude-modulated by means of AF signal with constant frequency and modulation index set with the <i>AF Frequency</i> and <i>Modulation Index</i> softkeys. |
| | <i>FM</i> | RF carrier is frequency-modulated with the frequency and deviation set with the <i>FM Frequency</i> and <i>FM Deviation</i> softkeys. FM modulation is incompatible with the <i>Aux Tx</i> signal. |
| | <i>FM Stereo</i> | FM stereo transmitter mode, to be configured in the <i>FM Stereo</i> section. The FM stereo transmitter is incompatible with the <i>Aux TX</i> signal. |
| Note: | <i>The AM setting shifts the level ranges of all three RF outputs by –6 dB. Generating a FM modulated signal which is accurate over the full FM Frequency and FM Deviation parameter range requires an FM Modulation Calibration; see description of the Maintenance menu. It is sufficient to perform the calibration once after installing the RF software; the CMU will store the calibration data.</i> | |

Remote control `SOURCE:RFGenerator:MODulation`
OFF | SSB | DSB | AM | FM | FMST

FM Stereo The FM stereo transmitter of the R&S CMU provides a single-tone audio signal and a pilot signal at fixed frequency. The default frequency deviations correspond to the rated values for the 75 kHz system:

- The frequency deviation of the pilot signal is equal to 9 % of the rated maximum system deviation, i.e. 6.75 kHz.
- The frequency deviation of the audio signal is equal to 90 % of the rated maximum system deviation, i.e. 67.5 kHz. This value is specified for stereo transmission. If needed, the frequency deviation for a mono signal can be changed to the rated value of 75 kHz.

Pilot Frequency Displays the frequency of the pilot signal; see [Fig. 4-56](#) on p. 4.130. The specified value of 19 kHz can not be changed.

Pilot Deviation Frequency deviation of the pilot tone.

Audio Frequency Variable frequency of the transmitted audio tone.

Audio Deviation Frequency deviation of the audio tone.

Audio Mapping Selection of the transmission channel for the audio signal; see [Fig. 4-56](#) on p. 4.130. If the audio signal is transmitted as a mono signal, the stereo band is not occupied (L = R). A left channel and a right channel signal generate equal mono contributions but stereo contributions with different sign. The pilot signal is transmitted irrespective of the audio mapping.

Remote control `SOURCE:RFGenerator:MODulation:FMSTereo:PIlot:FREquency?`
`SOURCE:RFGenerator:MODulation:FMSTereo:PIlot:DEVIation`
`SOURCE:RFGenerator:MODulation:FMSTereo:AUDio:FREquency`
`SOURCE:RFGenerator:MODulation:FMSTereo:AUDio:DEVIation`
`SOURCE:RFGenerator:MODulation:FMSTereo:AUDio:MAPPING`
MONO | LEFT | RIGHT

Contents

| | |
|---|-------------|
| 5 Remote Control – Basics | 5.1 |
| Introduction | 5.1 |
| Operation via Remote Control | 5.2 |
| Switchover to Remote Control..... | 5.2 |
| Setting the Device Address..... | 5.2 |
| Indications during Remote Control..... | 5.3 |
| Return to Manual Operation..... | 5.5 |
| Setting the Transmission Parameters (RS-232 Interface)..... | 5.6 |
| GPIB Bus Messages | 5.7 |
| Interface Message..... | 5.7 |
| Device Messages (Commands and Device Responses)..... | 5.7 |
| SCPI Command Structure and Syntax | 5.8 |
| Structure of a Command Line | 5.10 |
| Responses to Queries..... | 5.10 |
| Parameters..... | 5.11 |
| Overview of Syntax Elements | 5.12 |
| Instrument Model and Command Processing | 5.13 |
| Input Unit..... | 5.13 |
| Command Recognition..... | 5.14 |
| Data Set and Instrument Hardware..... | 5.14 |
| Status Reporting System..... | 5.14 |
| Output Unit | 5.15 |
| Command Sequence and Command Synchronization | 5.15 |
| Status Reporting System | 5.16 |
| Structure of an SCPI Status Register..... | 5.16 |
| Overview of the Status Registers..... | 5.18 |
| Status Byte (STB) and Service Request Enable Register (SRE)..... | 5.20 |
| IST Flag and Parallel Poll Enable Register (PPE) | 5.21 |
| Event Status Register (ESR) and Event Status Enable Register (ESE)..... | 5.21 |
| STATus:OPERation Register..... | 5.22 |
| STATus:QUEStionable-Register..... | 5.23 |
| Application of the Status Reporting System | 5.24 |
| Service Request..... | 5.24 |
| Symbolic Status Event Register Evaluation | 5.25 |
| Serial Poll | 5.25 |
| Parallel Poll | 5.25 |
| Query by Means of Commands | 5.26 |
| Error Queue Query..... | 5.26 |

| | |
|--|-------------|
| Reset Values of the Status Reporting Systems | 5.27 |
| Measurement Control..... | 5.28 |
| Measurement Groups and Applications | 5.28 |
| Measurement Control Commands and States | 5.29 |
| Event Reporting..... | 5.32 |
| Measurement Status | 5.34 |
| Generator Control..... | 5.35 |
| Generator Status | 5.36 |
| Measurement Statistics | 5.36 |
| Specifying Limits | 5.37 |
| Retrieving Measurement Results | 5.38 |
| Diagrammatic Overview of Measurement Control | 5.41 |
| Single Shot Measurements | 5.41 |
| Counting Measurements..... | 5.42 |
| Continuous Measurements | 5.43 |
| Task Priority Management | 5.44 |

5 Remote Control – Basics

This chapter provides:

- Instructions on how to set up the R&S® CMU for remote control operation.
- A general introduction to remote control of programmable instruments. This includes the description of the command structure and syntax according to the SCPI standard, the description of command execution and of the status registers.
- A comprehensive description of the R&S® CMU's remote control concept.

In Chapter 6, all remote control functions of the base system and of function groups *RF* and are described in detail. The commands for each function group and their parameters are listed according to their function and in alphabetical order in the command lists at the end of Chapter 6.

Program examples for the R&S® CMU can be found in Chapter 7.

Introduction

The instrument is equipped with a GPIB bus interface according to standard IEC 625.1/IEEE 488.1. The connectors are located at the rear of the instrument and permit a connection to a controller for remote control.

This section assumes basic knowledge of GPIB bus programming and operation of the controller. A description of the interface commands can be found in the relevant manuals.

Not all of the commands supported by the instrument are taken from the SCPI standard (Standard Commands for Programmable Instruments), however, their syntax follows SCPI rules. The SCPI standard is based on standard IEEE 488.2 and aims at the standardization of device-specific commands, error handling and the status registers.

The requirements that the SCPI standard places on command syntax, error handling and configuration of the status registers are explained in detail in the following sections. Tables provide a fast overview of the bit assignment in the status registers. The tables are supplemented by a comprehensive description of the status registers.

Note: *In contrast to instruments with manual control, which are designed for maximum possible operating convenience, the priority of remote control is the "predictability" of the device status. This means that when incompatible settings are attempted, the command is ignored and the device status remains unchanged, i.e. other settings are not automatically adapted. Therefore, GPIB bus control programs should always define an initial device status (e.g. with the command *RST) and then implement the required settings.*

Operation via Remote Control

As with any device, the R&S® CMU must be assigned a unique primary address in the range 0 to 30. In addition it uses extended addressing, i.e. a secondary address must be assigned to the individual function groups. Primary and secondary addresses can be defined in the *Remote* index card of the *Setup* menu (see Chapter 4) or via remote control.

Switchover to Remote Control

On power-up, the instrument is always in the manual operating state and can be operated via the front panel controls. The instrument is switched to remote control in the following cases:

| | |
|------------------------------|---|
| With active GPIB bus | as soon as the Remote Enable (REN) GPIB line is asserted by the controller. |
| With active RS-232 interface | as soon as the instrument receives any characters via the interface. |

Operation via the front panel is disabled. The instrument remains in the remote state until it is reset to the manual state via the front panel or via GPIB bus (see section [Return to Manual Operation](#)).

Note: **Local to remote transition and signalling states**

Switching from manual operation to remote control does usually not affect the device settings. However, if the R&S® CMU operates in a Non Signalling test mode, all generators are switched off. In a Signalling mode, the current connection or call is dropped and the R&S® CMU returns to its default signalling state.

To change this behavior and preserve the generator and signalling states in a local to remote transition, the command `SYSTem:GTRMode:COMPAtible OFF` can be used; see Chapter 6.

Note: **Accelerating the Shut Down Process**

The version of the Front Module controller has an impact on the shut down process of the instrument; see Chapter 1, section Switching off the Instrument. When operating instruments equipped with an FMR 6 in remote control mode, it is recommended to disable the nonvolatile RAM, see command `SYSTem:NONVolatile:DISable` in Chapter 6.

Setting the Device Address

The GPIB address (primary address) of the instrument is factory-set to 20. It can be changed manually via the *Primary Address* softkey in the *Setup - Remote* menu or via GPIB bus. For remote control, addresses 0 through 30 are permissible.

In addition to the primary address, up to 30 secondary addresses can be assigned to the individual function groups and test modes. This concept of extended addressing allows the same remote commands to be used in several function groups and modes. Secondary address 0 is reserved for the R&S® CMU base system. The other secondary addresses are set via the *Second. Address* softkey in the *Setup - Remote* menu or via remote control.

Note: *In the Setup – Remote menu, secondary addresses between 1 and 29 can be assigned. When using the National Instruments driver, add 96 to the secondary address. For example, specify a secondary address of 96 to access secondary address 0 on the instrument.*

Changing the addresses manually:

1. Call *Setup - Remote* menu.
2. Press *Primary Address* softkey. Enter desired address in the input field.

3. Press *Second*. *Address* softkey. Use the rollkey to select the list line with the desired address (numbers 1 to 29). Press ENTER to edit the line. From the popup window select the desired function group (use the rollkey to change between the entries in the popup window). Confirm your selection and close the popup window using the ENTER key.
4. Press the *ESCAPE* key to close the *Setup – Remote* menu.

Via GPIB bus interface:

- Use the `SYSTem:REMOte:ADDRes:PRIMary <Addr_1>` command to define the GPIB bus address of the R&S® CMU.
- Use the `SYSTem:REMOte:ADDRes:SECOndary <Addr_2>,"<Fgroup>"` command to assign distinct secondary addresses to all function groups needed. The secondary address is transferred with each command (physical/hardware addressing, see program example in Chapter 7). Alternatively, software switchover with a command preceded by a secondary address and a semicolon is possible:

`<Addr_2>;<Command>` (logical addressing of secondary address; use semicolon)

Via RS-232 interface:

- Use the `SYSTem:REMOte:ADDRes:PRIMary <Addr_1>` command to define the GPIB bus address of the R&S® CMU.
- Use the `SYSTem:REMOte:ADDRes:SECOndary <Addr_2>,"<Fgroup>"` command to assign distinct secondary addresses to all function groups needed.
- Use the `*SEC <Addr_2>` command for a software switchover from one secondary address to another. Alternatively place `<Addr_2>;` in front of the command:

`*SEC <Addr_2>` followed by `<Command>` is equivalent to `<Addr_2>;<Command>`, provided that secondary address `<Addr_2>` has been appropriately defined.

Indications during Remote Control

In the REMOTE state no menus but only the header *Remote* is indicated.

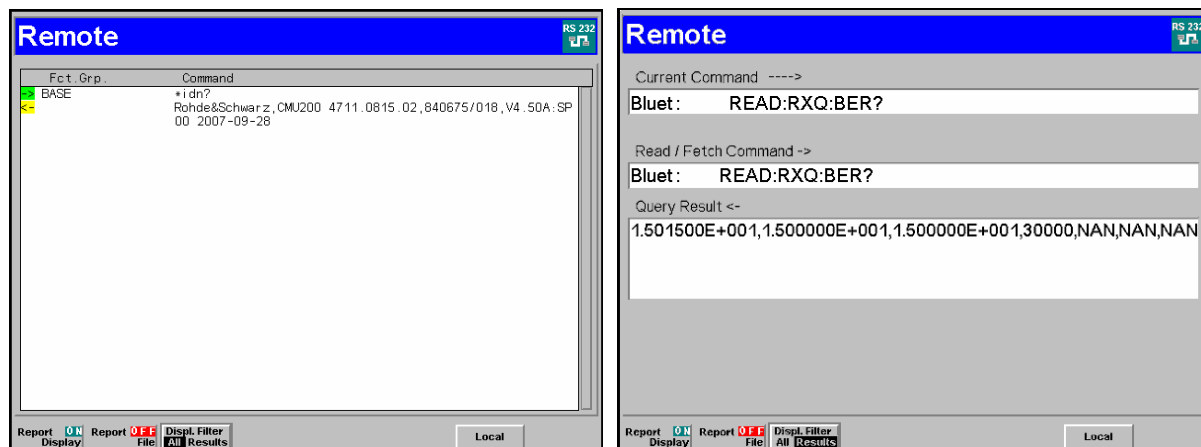

Fig. 5-1 Remote screen

Report
Display

The *Report Display* hotkey can be activated (state *ON*, press the *ON/OFF* key) to display the input and output strings of the remote-control interface on the *Remote* screen. The remote display consists of three columns:

- <Input/output>* Colored symbols for input (→) to the R&S® CMU, output (←) or error messages (E).
- Fct. Grp.* Name of the addressed function group; see description of command `SYSTEM:REMOte:ADdResS:SECOndary` in Chapter 6.
- Command* Input command string, response/output string of the R&S® CMU or error message.

This parameter can also be set in the *Setup – Remote* menu; see chapter 4 or in the *Remote Service Tool*; see chapter 1.

Remote control

TRACe:REMOte:MODE:DISPlay ON | OFF

Displ. Filter
All Results

The *Display Filter* hotkey selects the appearance of the remote screen and the displayed information:

- All* The remote screen shows all remote control commands that are exchanged between the controller program and the R&S® CMU (see example on the left-hand side of Fig. 5-1 above).
- Results* The commands are filtered: The remote screen only shows the current command (with a switched icon to distinguish several repeated commands) and the last `READ...?` or `FETCh...?` query sent to the R&S CMU, together with the received results. Compared to *Report Mode: All*, the font size is enlarged, and the secondary address string is abbreviated to 5 characters (e.g. `WCDMA` for `WCDMAUEFDD_NSig`). (see example on the right-hand side of Fig. 5-1 above). This report mode is suited for a rough observation of the command sequence, with an emphasis of the received results.

Remote control

TRACe:REMOte:MODE:DISPlay:FILTer ON | OFF

Report
File

The *Report File* hotkey can be activated (state *ON*, press the *ON/OFF* key) to write the input and output strings of the remote-control interface to a file named `Remote.trc` in the root directory of the internal hard disk (*INTERNAL* directory in the *Data* menu or directory `C:\temp`). The two softkeys *Report Display* and *Report File* may be active (*ON*) at the same time.

This parameter can also be set in the *Setup – Remote* menu; see chapter 4 or in the *Remote Service Tool*; see chapter 1.

Remote control

TRACe:REMOte:MODE:FILE ON | OFF

Local

The *Local* hotkey switches back to manual control. The current measurement and generator states and the current signalling state (if a *Signalling* test mode is active) are preserved; see also section [Return to Manual Operation below](#).

Remote control

GTL interface message, included in the NI command `IBLOC (device%)` (addressed command; see Chapter 8)

Equivalent R&S® CMU-specific command, also for operation via serial interface:

*GTL

Return to Manual Operation

Return to manual operation can be initiated via the front panel or the GPIB bus.

Manually:

- Press any key on the front panel or press the *Local* hotkey in the *Remote* screen. The current measurement and generator states and the current signalling state (if a *Signalling* test mode is active) are preserved.

Note:

- Before returning to manual control, command processing must be completed. If this is not the case, the R&S® CMU switches back to remote control immediately.
- Returning to manual control by pressing any front panel key can be disabled by the GPIB Local Lockout Message (LLO; see Chapter 8, Table Universal Commands), which is also included in the NI commands *SetRWLS* (Set Remote With Lockout State) or *SendLLO*. This prevents unintentional switch-over, i.e. return to manual control is possible via the GPIB bus only. The R&S® CMU-specific command `*LLO TRUE` is equivalent to LLO.
- Returning to manual control via the front panel keys can be enabled again by deactivating the *REN* control line of the GPIB bus (see Chapter 8). The R&S® CMU-specific command `*LLO FALSE` also enables return to manual control.

Via GPIB bus:

```
...
CALL IBLOC(device%)           Set instrument to manual operation
...
```

Equivalent R&S® CMU-specific command, also for serial interface: `*GTL`

Target Menu

On switching over from remote to manual control, the R&S® CMU preserves the current measurement and generator states and the current signalling state (if a *Signalling* test mode is active). The instrument tries to open the menu that the user is likely to prefer, i.e. the measurement menu of the current, running measurement. If several measurements are running in parallel, the instrument applies the following selection rules to resolve the ambiguity and determine a preferred menu:

- The preferred menu must belong to a measurement that is in the *RUN* or *HLT* state (see section [Measurement Control Commands and States](#) on p. 5.29 ff.). *RDY* measurements and suppressed measurements are discarded.
- Measurement menus of the main application have the priority over configuration menus (e.g. for signalling and generators) and menus for additive applications (e.g. an *Audio* measurement that is performed in the context of a GSM-MS main application).
- Out of several running measurements of the same hierarchy level, the last one that was initiated (`INITiate:...` or `READ:...`?) is preferred.

If no measurement is in the *RUN* or *HLT* state, the last measurement that was aborted (`ABORT:...`) is preferred.

Setting the Transmission Parameters (RS-232 Interface)

To ensure a correct data transmission, the transfer parameters of the instrument and the controller must be identical. The number of data and stop bits, the parity, baud rate and the handshake mode can be set independently for the two interfaces COM 1 and COM 2 in the *Setup - Comm.* menu:

- Open *Setup - Comm.* menu and press one of the softkeys to select interface COM 1 or COM 2.
- Use the cursor keys and the rollkey to select and change desired parameters.
- Terminate the input using the *[ENTER]* key.

Alternatively, the COM parameters can be set via remote control: `SYSTEM:COMMunicate:SERial1...`

GPIB Bus Messages

The messages transferred via the data lines of the GPIB bus (see Chapter 8) can be either **interface messages** or **device messages**.

Interface Message

Interface messages are transferred on the data lines of the GPIB bus, the ATN control line being active. They are used for communication between controller and instrument and can only be sent by a computer which has the function of an GPIB bus controller.

Interface commands can be further subdivided into

- **universal commands**
- **addressed commands**

Universal commands act on all devices connected to the GPIB bus without previous addressing, addressed commands only act on devices previously addressed as listeners. The interface messages relevant to the instrument are listed in Chapter 8, section *Interface Messages*.

Device Messages (Commands and Device Responses)

Device messages are transferred via the data lines of the GPIB bus, the "ATN" control line not being active. The ASCII character set is used. A distinction is made according to the direction in which device messages are transferred:

Commands are messages the controller sends to the instrument. They operate the device functions and request information. The commands are subdivided according to two criteria:

1. According to the effect they have on the instrument:

Setting commands cause instrument settings such as a reset of the instrument or setting the output level to some value.

Queries cause data to be provided for output on the GPIB bus, e.g. for identification of the device or polling the active input.

2. According to their definition in standard IEEE 488.2:

Common Commands have a function and syntax that is exactly defined in standard IEEE 488.2. Typical tasks are the management of the standardized status registers, reset and selftest.

Device-specific Commands are functions that depend on the features of the instrument such as frequency setting. A majority of these commands has also been standardized by the SCPI committee.

Device responses are messages the instrument sends to the controller after a query. They can contain measurement results, instrument settings and information on the instrument status (cf. section 3.5.4).

Structure and syntax of the device messages are described in the next section. In Chapter 6 all commands are listed and explained in detail.

SCPI Command Structure and Syntax

SCPI commands consist of a so-called header and, in most cases, one or more parameters. The header and the parameters are separated by a "white space" (ASCII code 0 to 9, 11 to 32 decimal, e.g. blank). The headers may consist of several key words. Queries are formed by directly appending a question mark to the header.

Common Commands

Common (=device-independent) commands consist of a header preceded by an asterisk "*" and possibly one or more parameters.

Examples:

- *RST RESET, resets the instrument.
- *ESE 253 EVENT STATUS ENABLE, sets the bits of the event status enable registers.
- *ESR? EVENT STATUS QUERY, queries the contents of the event status register.

Device-specific commands

Hierarchy: Device-specific commands are of hierarchical structure (see Fig. 5-2). The different levels are represented by combined headers. Headers of the highest level (root level) have only one key word. This key word denotes a complete command system.

Example:

SOURce This key word denotes the command system SOURce.

For commands of lower levels, the complete path has to be specified, starting on the left with the highest level, the individual key words being separated by a colon ":".

Example:

SOURce:RFGenerator:TX:FREQuency 1MHZ

This command is located on the fourth level of the SOURce system. It switches on frequency hopping for the RF generator.

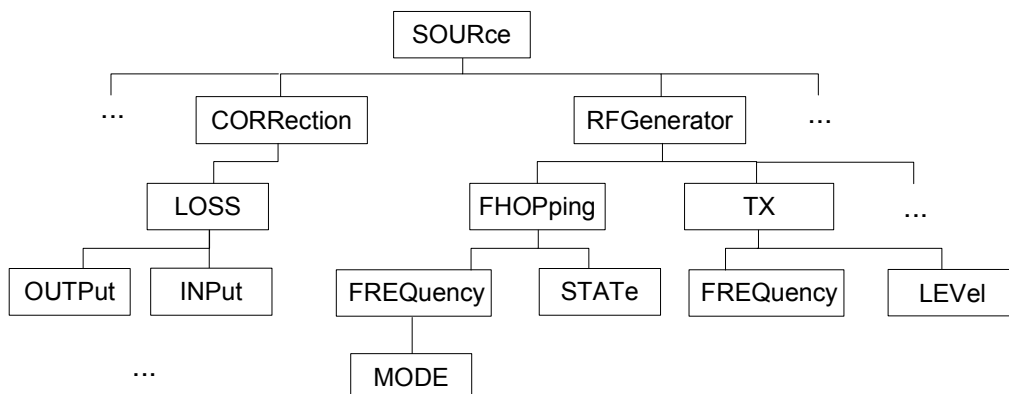

Fig. 5-2 Example for the tree structure of the SCPI command systems; the SOURce system

Multiple key words

Some key words occur on several levels within one command system. Their effect depends on the structure of the command, i. e. on the position in the command header they are inserted in.

Example: `SOURce:RFGenerator:TX:FREQuency 1GHZ`

This command contains the key word `SOURce` in the first command level. It defines the frequency of the RF generator signal.

`TRIGger:SOURce EXTern`

This command contains the key word `SOURce` in the second command level. It defines the trigger source “external trigger”.

Optional key words:

Some command systems permit certain key words to be optionally inserted into the header or omitted. These key words are marked by square brackets in this manual. The full command length must be recognized by the instrument for reasons of compatibility with the SCPI standard. Some commands are considerably shortened by omitting optional key words.

Example: `TRIGger[:SEQuence]:SOURce EXTern`

This command defines the trigger source “external trigger”. The following command has the same effect:

`TRIGger:SOURce EXTern`

Note: *An optional key word must not be omitted if its effect is additionally specified by a numeric suffix.*

Long and short form:

The key words feature a long form and a short form. Either the short form or the long form can be entered; other abbreviations are not permitted.

Example: `TRIGger:SOURce EXTern`
 `TRIG:SOUR EXT`

Note: *The short form is marked by upper-case letters, the long form corresponds to the complete word. Upper-case and lower-case notation only serves to distinguish the two forms in the manual, the instrument itself does not distinguish upper-case and lower-case letters.*

Parameters:

Parameters must be separated from the header by a "white space". If several parameters are specified in a command, they are separated by a comma ",". For a description of the types of parameter, refer to section [Parameters](#) on page 5.11.

Example: `CONFigure:WPOWer:CONTRol:REPetition`
 `SINGleshot,SONerror, NONE`

This command sets parameters to define the statistics of a power measurement.

Numeric suffix:

If a device features several functions or features of the same kind, e.g. several inputs, the desired function can be selected by a suffix added to the command. Entries without suffix are interpreted as entries with the suffix 1.

Example: `STATus:OPERation:CMU:SUM<nr>[:EVENT]?`

This command queries and deletes the contents of the `EVENT` part of the `STATus:OPERation:CMU:SUM<nr>` register. There are two sum registers numbered 1 and 2, respectively (`<nr> = 1,2`).

Structure of a Command Line

A command line may consist of one or several commands. It is terminated by a <New Line>, a <New Line> with EOI or an EOI together with the last data byte. Visual BASIC automatically produces an EOI together with the last data byte.

Several commands in a command line must be separated by a semicolon ";". If the next command belongs to a different command system, the semicolon is followed by a colon.

Example: `CALL IBWRT(device%, "TRIGger:SOURce EXTern;:FETCh:WPOWer:STATUs?")`

This command line contains two commands. The first command belongs to the `TRIGger` system and defines the trigger source (external trigger). The second command belongs to the `FETCh` system and returns the status of the power measurement.

If the successive commands belong to the same system, having one or several levels in common, the command line can be abbreviated. To this end, the second command after the semicolon starts with the level that lies below the common levels (see also Fig. 5.1). The colon following the semicolon must be omitted in this case.

Example: `CALL IBWRT(device%, "TRIG:SOUR EXT;:TRIG:THR:RFP LOW")`

This command line is represented in its full length and contains two commands separated from each other by the semicolon. Both commands are part of the `TRIGger` command system, i.e. they have one level in common.

When abbreviating the command line, the second command begins with the level below `TRIG`. The colon after the semicolon is omitted.

The abbreviated form of the command line reads as follows:

`CALL IBWRT(device%, "TRIG:SOUR EXT;THR:RFP LOW")`

However, a new command line always begins with the complete path.

Example: `CALL IBWRT(device%, "TRIG:SOUR EXT ")`
`CALL IBWRT(device%, "TRIG:THR:RFP LOW ")`

Responses to Queries

A query is defined for each setting command unless explicitly specified otherwise. It is formed by adding a question mark to the associated setting command. According to SCPI, the responses to queries are partly subject to stricter rules than in standard IEEE 488.2.

1. The requested parameter is transmitted without header.

Example: `TRIGger:THReshold:RFPower?` Response: LOW

2. Maximum values, minimum values and all further quantities, which are requested via a special text parameter are returned as numerical values.

Example: `CONFigure:WPOWer:CONTRol:REPetition? MAX` Response: 10000

3. Numerical values are output without their unit. The default unit for each command is reported in the command description on Chapter 6.

Example: `SOURce:RFGenerator:FREQuency?` Response: 1E9 for 1 GHz

4. Boolean values are returned as 0 (for OFF) and 1 (for ON).

Example: `SOURce:DM:CLOCK:STATe?` Response: 1

5. Text (character data) is returned in short form (see also next section).

Example: `FETCh:WPOWer:STATUs?` Response: ERR

Parameters

Most commands require a parameter to be specified. The parameters must be separated from the header by a "white space". Permissible parameters are numerical values, Boolean parameters, text, character strings and block data. The type of parameter required for the respective command and the permissible range of values are specified in the command description.

Numerical values Numerical values can be entered in any form, i.e. with sign, decimal point and exponent. Values exceeding the resolution of the instrument are rounded up or down. The mantissa may comprise up to 255 characters, the values must be in the value range $-9.9E37$ to $9.9E37$. The exponent is introduced by an "E" or "e". Entry of the exponent alone is not allowed. In the case of physical quantities, the unit can be entered. Permissible unit prefixes are G (giga), MA (mega), MOHM and MHZ are also permissible), K (kilo), M (milli), U (micro) and N (nano). If the unit is missing, the fundamental unit is used.

Example: SOUR:RFG:FREQ 1.5GHz is equivalent to
SOUR:RFG:FREQ 1.5E9

Special numerical values The texts MINimum, MAXimum, DEFault, UP and DOWN are interpreted as special numerical values.

In the case of a query, the associated numerical value is provided.

Example: Setting command: CONF:WPOW:CONT:REP
MAXimum, NONE, NONE
Query: CONF:WPOW:CONT:REP?
Response: 10000, NONE, NONE

MIN/MAX MINimum and MAXimum denote the minimum and maximum value.

DEF DEFault denotes the preset value. This value is set by the *RST command.

INF/NINF INFINITY, Negative INFINITY (NINF) represent the numerical values $-9.9E37$ or $9.9E37$, respectively. INF and NINF are only sent as device responses.

NAN Not a Number (NAN) represents the value $9.91E37$. NAN is only sent as device response. This value is not defined. Possible causes are division by zero, subtraction or addition of infinite and the representation of missing values.

Boolean Parameters Boolean parameters represent two states. The ON state (logically true) is represented by ON or a numerical value different from 0. The OFF state (logically untrue) is represented by OFF or the numerical value 0. A query responds with 0 or 1.

Example: Setting command: SOURce:DM:CLOCK:STATe ON
Query: SOURce:DM:CLOCK:STATe?
Response: 1

Text Text parameters observe the syntax rules for key words, i.e. they can be entered using a short or long form. Like any parameter, they have to be separated from the header by a white space. In the case of a query, the short form of the text is provided.

Example: Setting command: TRIGger:SOURce EXTern
Query: TRIGger:SOURce? Response: EXT

Strings Strings must always be entered within quotation marks (' or ").

Example: :SYST:REM:ADDR:SEC 1,"Bluetooth_NSig" or
 :SYST:REM:ADDR:SEC 1,'Bluetooth_Nsig'

Block data

Block data are a transmission format which is suitable for the transmission of large amounts of data. A command using a block data parameter with definite length has the following structure:

Example: :HEADer:HEADer #45168xxxxxxxx

The hash symbol # introduces the data block. The next number indicates how many of the following digits describe the length of the data block. In the example the 4 following digits indicate the length to be 5168 bytes. The data bytes follow. During the transmission of these data bytes all End or other control signs are ignored until all bytes are transmitted.

A #0 combination introduces a data block of indefinite length. The use of the indefinite format requires a NL^END message to terminate the data block. This format is useful when the length of the transmission is not known or if speed or other considerations prevent segmentation of the data into blocks of definite length.

Overview of Syntax Elements

- : The colon separates the key words of a command. In a command line the separating semicolon marks the uppermost command level.
- ; The semicolon separates two commands of a command line. It does not alter the path.
- ,
- ? The question mark forms a query.
- * The asterisk marks a common command.
- " Quotation marks introduce a string and terminate it.
- # The hash sign # introduces binary, octal, hexadecimal and block data.
 - Binary: #B10110
 - Octal: #O7612
 - Hexadecimal: #HF3A7
 - Block: #21312

A "white space" (ASCII-Code 0 to 9, 11 to 32 decimal, e.g. blank) separates header and parameter.

Instrument Model and Command Processing

The block diagram in figure [Fig. 5-3](#) shows how GPIB bus commands are serviced in the instrument. The individual components work independently and simultaneously. They communicate with each other by means of so-called "messages".

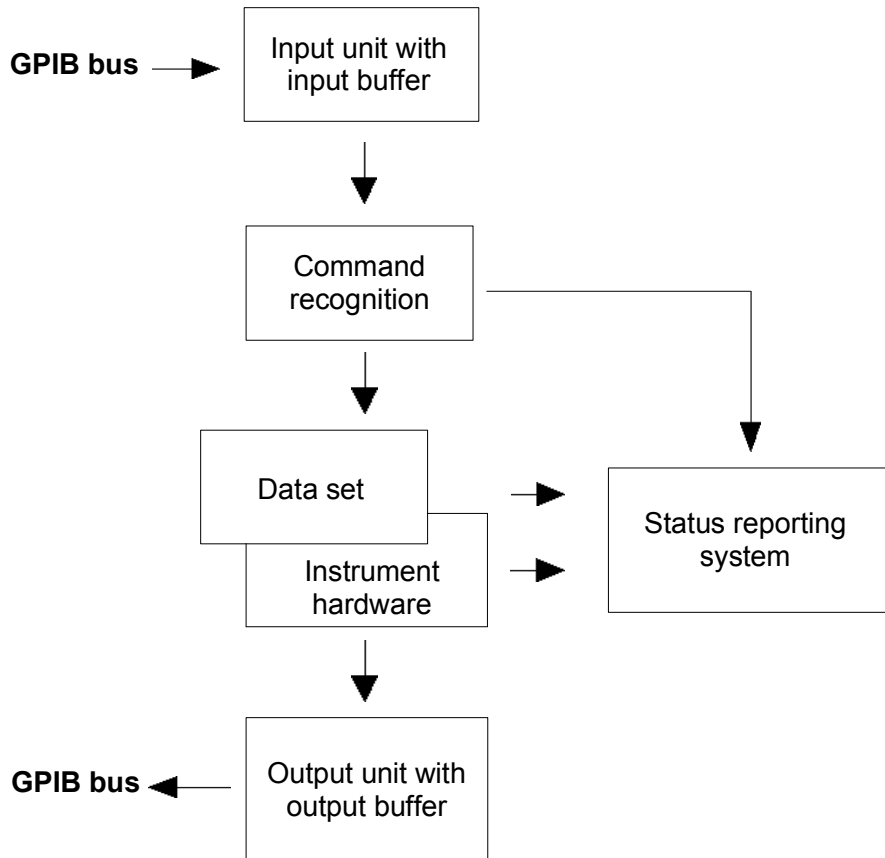

Fig. 5-3 Instrument model in the case of remote control via GPIB bus

Input Unit

The input unit receives commands character by character from the GPIB bus and collects them in the input buffer. The input unit sends a message to the command recognition as soon as the input buffer is full or as soon as it receives a delimiter, <PROGRAM MESSAGE TERMINATOR>, as defined in IEEE 488.2, or the interface message DCL.

If the input buffer is full, the GPIB bus traffic is stopped and the data received up to then is processed. Subsequently the GPIB bus traffic is continued. If, however, the buffer is not yet full when receiving the delimiter, the input unit can already receive the next command during command recognition and execution. The receipt of a DCL clears the input buffer and immediately initiates a message to the command recognition.

Command Recognition

The command recognition stage analyzes the data received from the input unit. It proceeds in the order in which it receives the data. Only a DCL is serviced with priority, e.g. a GET (Group Execute Trigger) is only executed after the commands received before. Each recognized command is immediately transferred to the data set but not executed immediately.

The command recognition detects syntax errors in the commands and transfers them to the status reporting system. The rest of a command line after a syntax error is ignored.

If the command recognition detects a delimiter or a DCL, it also requests the data set to perform the necessary instrument hardware settings. Subsequently it is immediately prepared to process further commands. This means that new commands can already be serviced while the hardware is still being set ("overlapping execution").

Data Set and Instrument Hardware

The expression "instrument hardware" denotes the part of the instrument fulfilling the actual instrument function - signal generation, measurement etc. The controller is not included. The data set is a detailed software reproduction of the instrument hardware.

GPIB bus setting commands lead to an alteration in the data set. The data set management enters the new values (e.g. frequency) into the data set, however, it only passes them on to the hardware when requested by the command recognition. As this is only ever effected at the end of a command line, the order of the setting commands in the command line is not relevant.

The commands are only checked for their compatibility among each other and with the instrument hardware immediately before they are transmitted to the instrument hardware. If the detection is made that execution is not possible, an "execution error" is signalled to the status reporting system. All alterations of the data set are canceled, the instrument hardware is not reset. Due to the delayed checking and hardware setting, however, impermissible instrument states can be set for a short period of time within one command line without this leading to an error message (example: simultaneous activation of FM and PM). At the end of the command line, however, a permissible instrument state must have been reached again.

Before passing on the data to the hardware, the settling bit in the `STATUS:OPERation` register is set (cf. section [STATUS:OPERation Register](#)). The hardware executes the settings and resets the bit again as soon as the new state has settled. This fact can be used to synchronize command servicing.

GPIB bus queries induce the data set management to send the desired data to the output unit.

Status Reporting System

The status reporting system collects information on the instrument state and makes it available to the output unit on request. The exact structure and function are described in section [Status Reporting System](#) on page 5.16.

Output Unit

The output unit collects the information requested by the controller, which it receives from the data set management. It processes it according to the SCPI rules and makes it available in the output buffer. If the information requested is longer, it is made available "in portions" without this being recognized by the controller.

If the instrument is addressed as a talker without the output buffer containing data or awaiting data from the data set management, the output unit sends the error message "Query UNTERMINATED" to the status reporting system. No data are sent on the GPIB bus, the controller waits until it has reached its time limit. This behavior is specified by SCPI.

Command Sequence and Command Synchronization

What was said above makes clear that overlapping execution is possible in principle for all commands. Equally, setting commands within one command line are not absolutely serviced in the order in which they have been received.

In order to make sure that commands are actually carried out in a certain order, each command must be sent in a separate command line, that is to say, with a separate IBWRT()-call.

In order to prevent an overlapping execution of commands, one of commands *OPC, *OPC? or *WAI must be used. All three commands cause a certain action only to be carried out after the hardware has been set and has settled. By suitable programming, the controller can be forced to wait for the respective action to occur (cf. [Table 5-1](#)).

Table 5-1 Synchronization with *OPC, *OPC? and *WAI

| Command | Action after the hardware has settled | Programming the controller |
|---------|---|---|
| *OPC | Setting the operation-complete bit in the ESR | - Setting bit 0 in the ESE - Setting bit 5 in the SRE - Waiting for service request (SRQ) |
| *OPC? | Writing a "1" into the output buffer | Addressing the instrument as a talker |
| *WAI | Executing the next command Note: The GPIB bus handshake is not stopped | Sending the next command |

Status Reporting System

The status reporting system (cf. Fig. 5-5) stores all information on the present operating state of the instrument, and on errors which have occurred. This information is stored in the status registers and in the error queue. The status registers and the error queue can be queried via GPIB bus.

The information is of a hierarchical structure. The register status byte (STB) defined in IEEE 488.2 and its associated mask register service request enable (SRE) form the uppermost level. The STB receives its information from the standard event status register (ESR) which is also defined in IEEE 488.2 with the associated mask register standard event status enable (ESE) and registers `STATUS:OPERation` and `STATUS:QUEStionable` which are defined by SCPI and contain detailed information on the instrument.

The IST flag ("Individual Status") and the parallel poll enable register (PPE) allocated to it are also part of the status reporting system. The IST flag, like the SRQ, combines the entire instrument status in a single bit. The PPE fulfills an analog function for the IST flag as the SRE for the service request.

The output buffer contains the messages the instrument returns to the controller. It is not part of the status reporting system but determines the value of the MAV bit in the STB and thus is represented in Fig. 5-5.

Structure of an SCPI Status Register

Each standard SCPI register consists of 5 parts which each have a width of 16 bits and have different functions (cf. Fig. 5-4). The individual bits are independent of each other, i.e. each hardware status is assigned a bit number which is valid for all five parts. Bit 15 (the most significant bit) is set to zero for all parts. Thus the contents of the register parts can be processed by the controller as positive integer.

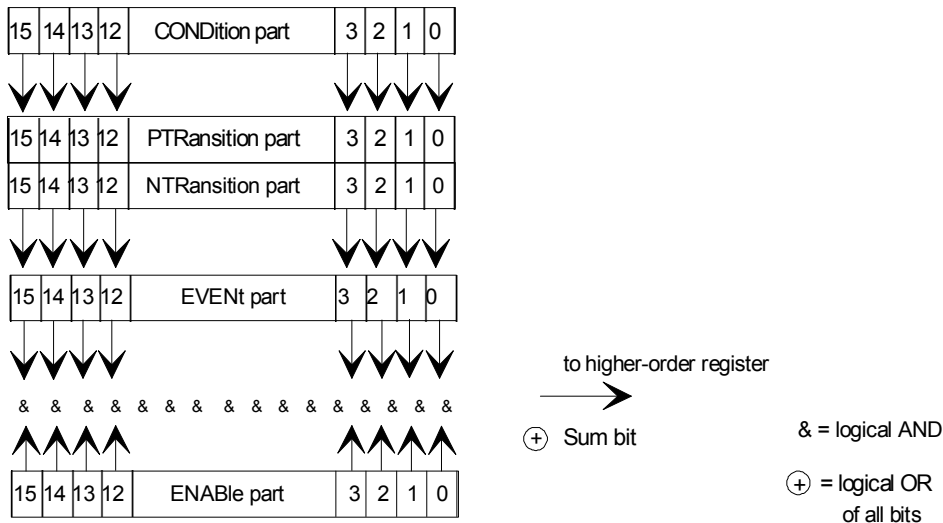

Fig. 5-4 The status register model

| | |
|-------------------------|--|
| CONDition part | The CONDition part is permanently overwritten by the hardware or the sum bit of the next lower register. Its contents always reflect the current instrument status. This register part can only be read, but not overwritten or cleared. Reading the CONDition register is nondestructive. |
| PTRansition part | The <u>P</u> ositive- <u>T</u> Ransition part acts as a transition filter. When a bit of the CONDition part is changed from 0 to 1, the associated PTR bit decides whether the EVENT bit is set to 1. PTR bit =1: the EVENT bit is set. PTR bit =0: the EVENT bit is not set. This status register part can be overwritten and read at will. Reading the PTRansition register is nondestructive. |
| NTRansition part | The <u>N</u> egative- <u>T</u> Ransition part also acts as a transition filter. When a bit of the CONDition part is changed from 1 to 0, the associated NTR bit decides whether the EVENT bit is set to 1. NTR bit =1: the EVENT bit is set. NTR bit =0: the EVENT bit is not set. This part can be overwritten and read at will. Reading the PTRansition register is nondestructive. With these two transition register parts the user can define which state transition of the condition part (none, 0 to 1, 1 to 0 or both) is stored in the EVENT part. |
| EVENT part | The EVENT part indicates whether an event has occurred since the last reading, it is the "memory" of the condition part. It only indicates events passed on by the transition filters. It is permanently updated by the instrument. This part can only be read by the user. Reading the register clears it. This part is often equated with the entire register. The R&S® CMU implementation of the EVENT parts of all status registers differs from the SCPI specification: The bits in the EVENT part are directly set by the instrument as soon as the instrument state changes so that the setting condition becomes true. The CONDition, PTRansition, and NTRansition register parts are not needed. The EVENT part is cleared upon reading. |
| ENABLE part | The ENABLE part determines whether the associated EVENT bit contributes to the sum bit (cf. below). Each bit of the EVENT part is ANDed with the associated ENABLE bit (symbol '&'). The results of all logical operations of this part are passed on to the sum bit via an OR function (symbol '+'). ENAB bit =0: the associated EVENT bit does not contribute to the sum bit ENAB bit =1: if the associated EVENT bit is "1", the sum bit is set to "1" as well. This part can be written into and read by the user at will. Its contents is not affected by reading. |
| Sum bit | As indicated above, the sum bit is obtained from the EVENT and ENABLE part for each register. The result is then entered into a bit of the CONDition part of the higher-order register. The instrument automatically generates the sum bit for each register. Thus an event, e.g. a PLL that has not locked, can lead to a service request throughout all levels of the hierarchy. |
| Note: | <i>The service request enable register SRE defined in IEEE 488.2 can be taken as ENABLE part of the STB if the STB is structured according to SCPI. By analogy, the ESE can be taken as the ENABLE part of the ESR.</i> |

Overview of the Status Registers

Fig. 5-5 shows the status registers used in the R&S® CMU. The `STATUS:QUESTIONABLE` register is not used. In addition to the standard `STATUS:OPERATION` register, the R&S® CMU offers 30 independent `STATUS:OPERATION:CMU:SUM1|2:CMU<nr>` sub-registers (<nr>=1 ... 15).

Cascading registers

The hierarchical structure of the `STATUS:OPERATION` register was designed with the aim of reporting and specifying the events generated during different measurements independently. Each sub-register receives entries from a particular combination of a function group and signalling mode (e.g. *RF Non Signalling*, *Bluetooth Signalling* etc.). The function groups and modes are identified by means of their secondary address, an integer number between 0 and 29. Secondary address 0 is reserved for the R&S® CMU base system. The remaining secondary addresses can be arbitrarily assigned or queried via the `SYSTEM:REMOTE:ADDRESS:SECONDARY` command (see Chapter 6). The assignment between sub-registers and secondary addresses is as follows:

| Sub-register | Secondary Address | Sub-register | Secondary Address |
|--------------------------|----------------------------------|--------------------------|-------------------|
| STAT:OPER:CMU:SUM1:CMU1 | 0 (reserved for CMU base system) | STAT:OPER:CMU:SUM2:CMU1 | 15 |
| ... | ... | ... | ... |
| STAT:OPER:CMU:SUM1:CMU15 | 14 | STAT:OPER:CMU:SUM2:CMU15 | 29 |

Contents of the sub-registers

The higher-level `STATUS:OPERATION` registers summarize the sub-registers as shown in Fig. 5-5. E.g., if the corresponding `ENABLE` bit is set, any `EVENT` reported in one of the `STATUS:OPERATION:CMU:SUM1|2:CMU<nr>` sub-registers sets the sum bit of the `STATUS:OPERATION:CMU:SUM1|2` register to 1.

This means that the `STATUS:OPERATION` register indicates whether any event occurred, the lower-level `STATUS:OPERATION:CMU:SUM1|2` registers indicate the function group and signalling mode in which the event occurred, the lowest-level `STATUS:OPERATION:CMU:SUM1|2` registers indicate the nature of the individual events.

The meaning of the bits in function group *RF Non Signalling* is given below (see section [STATUS:OPERATION Register](#) on p. 5.22 ff.). For other function groups refer to the relevant manuals.

Accessing the sub-registers

Every single status register can be configured and queried individually by means of the commands of the `STATUS:OPERATION` subsystem (see Chapter 6).

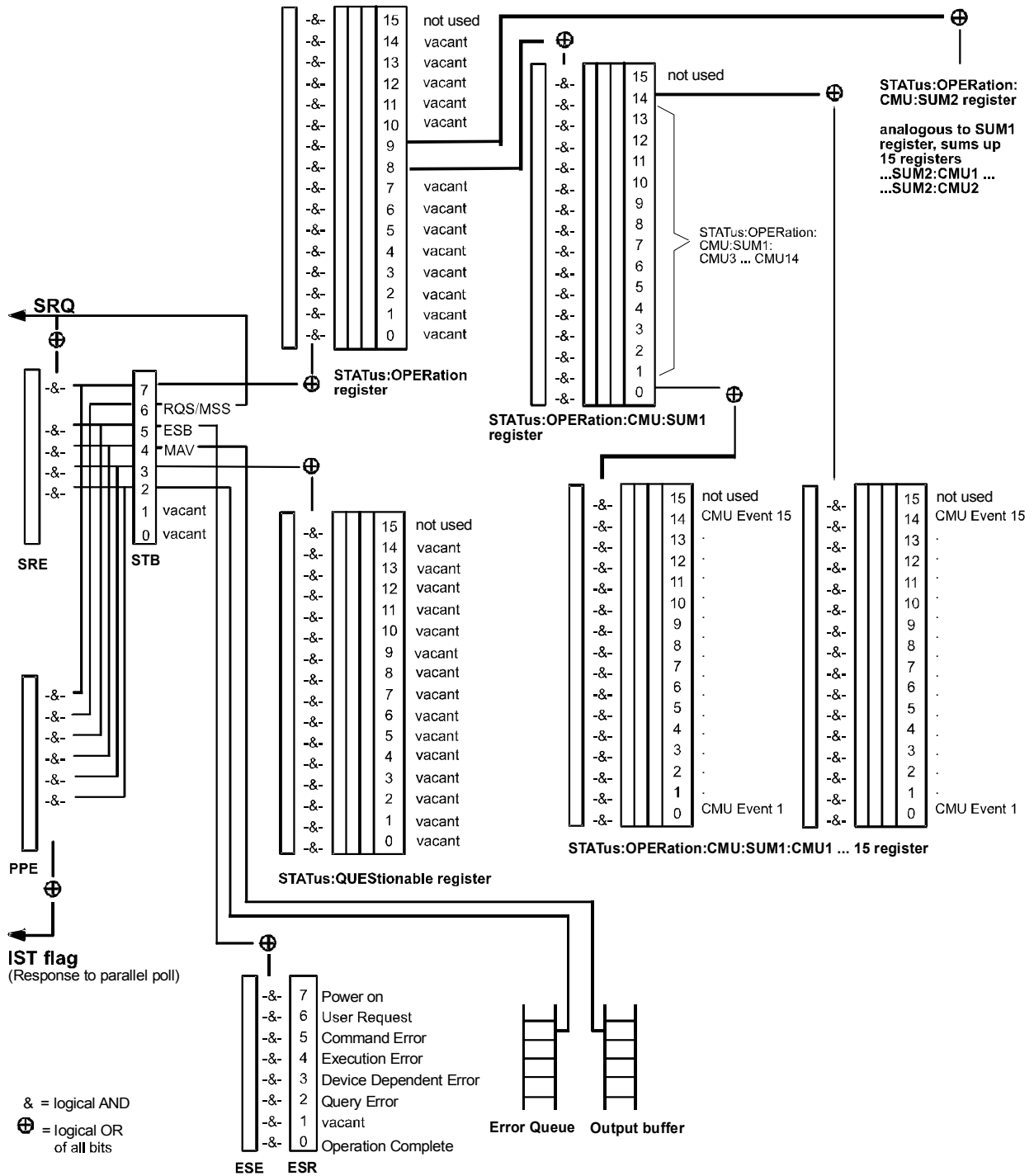

Fig. 5-5 The status registers

Status Byte (STB) and Service Request Enable Register (SRE)

The STB is already defined in IEEE 488.2. It provides a rough overview of the instrument status by collecting the pieces of information of the lower registers. It can thus be compared with the CONDition part of an SCPI register and assumes the highest level within the SCPI hierarchy. A special feature is that bit 6 acts as the sum bit of the remaining bits of the status byte.

The status byte is read out using the command `"*STB?"` or a serial poll.

The STB is linked to the SRE. The latter corresponds to the ENABLE part of the SCPI registers in its function. Each bit of the STB is assigned a bit in the SRE. Bit 6 of the SRE is ignored. If a bit is set in the SRE and the associated bit in the STB changes from 0 to 1, a Service Request (SRQ) is generated on the GPIB bus, which triggers an interrupt in the controller if this is appropriately configured and can be further processed there.

The SRE can be set using command `"*SRE"` and read using `"*SRE?"`.

Table 5-2 Meaning of the bits used in the status byte

| Bit no. | Meaning |
|---------|---|
| 2 | <p>Error Queue not empty</p> <p>This bit is set when an entry is made in the error queue. If this bit is enabled by the SRE, each entry of the error queue generates a Service Request. Thus an error can be recognized and specified in greater detail by polling the error queue. The poll provides an informative error message. This procedure is to be recommended since it considerably reduces the problems involved with GPIB bus control.</p> |
| 3 | <p>QUESTionable status sum bit</p> <p>This bit is set if an EVENT bit is set in the QUESTionable status register and the associated ENABLE bit is set to 1. A set bit indicates a questionable instrument status, which can be specified in greater detail by polling the QUESTionable status register.</p> |
| 4 | <p>MAV-Bit (Message AVailable)</p> <p>This bit is set if a message is available in the output buffer which can be read. This bit can be used to enable data to be automatically read from the instrument to the controller (cf. annex D, program examples).</p> |
| 5 | <p>ESB bit</p> <p>Sum bit of the event status register. It is set if one of the bits in the event status register is set and enabled in the event status enable register. Setting of this bit indicates a serious error which can be specified in greater detail by polling the event status register.</p> |
| 6 | <p>MSS-Bit (Master Status Summary bit)</p> <p>This bit is set if the instrument triggers a service request. This is the case if one of the other bits of this register is set together with its mask bit in the service request enable register SRE.</p> |
| 7 | <p>OPERation status register sum bit</p> <p>This bit is set if an EVENT bit is set in the OPERation status register and the associated ENABLE bit is set to 1. A set bit indicates that the instrument is just performing an action. The type of action can be queried by polling the OPERation status register.</p> |

IST Flag and Parallel Poll Enable Register (PPE)

By analogy with the SRQ, the IST flag combines the entire status information in a single bit. It can be queried by means of a parallel poll (cf. Section *Parallel Poll* on page 5.25) or using the command "*IST?".

The parallel poll enable register (PPE) determines which bits of the STB contribute to the IST flag. The bits of the STB are ANDed with the corresponding bits of the PPE, with bit 6 being used as well in contrast to the SRE. The IST flag results from the ORing of all results. The PPE can be set using commands "*PRE" and read using command "*PRE?".

Event Status Register (ESR) and Event Status Enable Register (ESE)

The ESR is defined in IEEE 488.2. It can be compared with the EVENT part of an SCPI register. The event status register can be read out using command "*ESR?".

The ESE is the associated ENABLE part. It can be set using the command "*ESE" and read using the command "*ESE?".

Table 5-3 Meaning of the bits used in the event status register

| Bit No. | Meaning |
|---------|--|
| 0 | Operation Complete This bit is set on receipt of the command *OPC exactly when all previous commands have been executed. |
| 2 | Query Error This bit is set if either the controller wants to read data from the instrument without having sent a query, or if it does not fetch requested data and sends new instructions to the instrument instead. The cause is often a query which is faulty and hence cannot be executed. |
| 3 | Device-dependent Error This bit is set if a device-dependent error occurs. An error message with a number between -300 and -399 or a positive error number, which denotes the error in greater detail, is entered into the error queue (cf. annex B, Error Messages). |
| 4 | Execution Error This bit is set if a received command is syntactically correct but cannot be performed for other reasons. An error message with a number between -200 and -300, which denotes the error in greater detail, is entered into the error queue (cf. annex B, Error Messages). |
| 5 | Command Error This bit is set if a command which is undefined or syntactically incorrect is received. An error message with a number between -100 and -200, which denotes the error in greater detail, is entered into the error queue (cf. annex B, Error Messages). |
| 6 | User Request This bit is not used in the R&S® CMU. |
| 7 | Power On (supply voltage on) This bit is set on switching on the instrument. |

STATus:OPERation Register

The R&S® CMU offers 30 independent STATus:OPERation:CMU:SUM1|2:CMU<nr> sub-registers (<nr>=1 ... 15) which are implemented in a hierarchical form. The bits of the 30 STATus:OPERation registers are set only after the registers are assigned to a function group and measurement mode (see p. 5.18).

In the EVENT part, the STATus:OPERation register contains information on which actions the instrument has executed since the last readout. All five parts of the registers can be read using one of the commands of the subsystem STATus:OPERation:CMU:SUM1|2:CMU<nr>:... . Moreover, the EVENT part can be enabled and read by means of the STATus:OPERation:SYMBOLic... commands, see section [Symbolic Status Event Register Evaluation](#) on page 5.25 ff.

The bit assignment for the R&S® CMU base system which is always assigned to the ...SUM1:CMU1 sub-register (secondary address 0) is as follows:

Table 5-4 Meaning of the bits used in the STATus:OPERation:CMU:SUM1:CMU1 sub-register assigned to the R&S® CMU base system

| Bit-No. | Meaning | Symbol in STATus:OPERation:SYMBOLic... |
|---------|--|---|
| 4 | Measurement Result is Invalid This bit is set if a measurement caused invalid results, e.g. because of no input signal was available (see also application example below and section Retrieving Measurement Results on p. 5.38 ff.). | MINV |
| 6 | Reference Frequency Not Locked This bit is set if synchronization to the reference frequency failed (e.g. because of a missing or faulty external reference frequency). The R&S® CMU checks the synchronization approx. once per second and updates the RFNL bit. Alternatively, the synchronization can be queried via [SENSe:]SYNChronize:FREQuency:REFErence:LOCKed? (see Chapter 6). | RFNL |
| 14 | Dynamic Host Error on Secondary Linkhandler This event occurs when the dynamic host (DHCP) procedure for the R&S CMU-B83 signalling unit fails. | DH2E |

For function group *RF Non Signalling*, the bit assignment is as follows:

Table 5-5 Meaning of the bits used in the STATus:OPERation:CMU:SUM1|2:CMU<nr> sub-register assigned to *RF Non Signalling*

| Bit-No. | Meaning | Symbol in STATus:OPERation:SYMBOLic... |
|---------|---|---|
| 0 | Overload This bit is set if the currently used input connector is overloaded. | IOV |
| 4 | Measurement Result is Invalid This bit is set if a measurement caused invalid results, e.g. because no input signal was available (see also application example below and section Retrieving Measurement Results on p. 5.38 ff.). | MINV |

| Bit-No. | Meaning | Symbol in STATus:OPERation:SYMBOLic... |
|---------|---|---|
| 11 | RF Input Overdriven This bit is set if the RF input level at the RF output connector RF 1, RF 2 or RF 4 IN is larger than the specified <i>RF Max. Level</i> plus an appropriate margin. | RFIO |
| 12 | RF Input Underdriven This bit is set while the RF input level at the RF output connector RF 1, RF 2 or RF 4 IN falls below the measurement range controlled by the specified <i>RF Max. Level</i> . | RFIU |

For optional function groups refer to the relevant manuals.

Application example (see also description of Winbatch tool in Chapter 7): The following command sequence shows how an event “Measurement Result is Invalid” is registered in the status reporting system and illustrates some of the tools that the R&S® CMU provides to monitor the instrument status.

...

| | |
|---------------------------------------|---|
| CMUBASE: *CLS | Clear status reporting system. |
| CMUBASE: TRACE:REMOTE:MODE:SRQ ON | Include service requests sent by the R&S® CMU in the remote control report. |
| CMUBASE: TRACE:REMOTE:MODE:DISPLAY ON | Display remote report on screen. |
| CMUBASE: *SRE 128 | Enable service request. |
| CMURFNS: STAT:OPER:SYMB:ENAB MINV | Enable event reporting for bit no. 4, MINV, in a different function group (RF Non Signalling). |
| CMURFNS: READ:RFAN:NPOW? | Initiate a single-shot RF analyzer power measurement using default settings and return results. In case of invalid measurement results (e.g. because no input signal is applied to the input connector of the R&S® CMU), a read symbol "S" for service request should appear on the screen. |
| CMUBASE: STAT:OPER:EVEN:SADD? | Check which function group reported an event. The query returns the RF function group. |
| CMURFNS: STAT:OPER:SYMB? | Query events reported by the RF function group: Bit MINV must be set |

STATus:QUEStionable-Register

This register contains information on questionable instrument states. They can occur, e.g. if the instrument is operated outside its specified range. It can be queried using one of the commands ":STATus:QUEStionable:CONDition?" or ":STATus:QUEStionable[:EVENT]?".

The R&S® CMU does not use this register.

Application of the Status Reporting System

In order to effectively use the status reporting system, the information contained there must be transmitted to the controller and further processed. There are several methods, which are outlined in the following.

Service Request

The instrument can send a service request (SRQ) to the controller. Usually this service request initiates an interrupt at the controller, to which the control program can react appropriately. As evident from Fig. 5-5, an SRQ is always initiated if one or several of bits 2, 3, 4, 5 or 7 of the status byte are set and enabled in the SRE. Each of these bits combines the information of a further register, the error queue or the output buffer. The ENABLE parts of the status registers can be set so that arbitrary bits in an arbitrary status register initiate an SRQ. In order to use the possibilities of the service request effectively, all bits should be set to "1" in the enable registers SRE and ESE.

Examples (cf. Fig. 5-5):

Use command `*OPC` to generate an SRQ

- Set bit 0 in the ESE (Operation Complete)
- Set bit 5 in the SRE (ESB)

After its settings have been completed, the instrument generates an SRQ.

Indication of an event (e.g. overloading of used input connector) by means of an SRQ with the controller:

- Set bit 7 in the SRE (sum bit of the `STATUS:OPERation` register)

The following steps depend on the secondary address ($0 \leq \langle \text{SecAddr} \rangle \leq 29$) assigned to the function group and signalling mode used.

$0 \leq \langle \text{SecAddr} \rangle \leq 14$

- Set bit 8 in the `STATUS:OPERation:ENABLE` register.
- Set bit $\langle \text{SecAddr} \rangle - 1$ in the `STATUS:OPERation:CMU:SUM1:ENABLE` register
- Set bit 0 in the `STATUS:OPERation:CMU:SUM1:CMU<SecAddr>:ENABLE` register.

$15 \leq \langle \text{SecAddr} \rangle \leq 29$

- Set bit 9 in the `STATUS:OPERation:ENABLE` register.
- Set bit $\langle \text{SecAddr} \rangle - 16$ in the `STATUS:OPERation:CMU:SUM2:ENABLE` register
- Set bit 0 in the `STATUS:OPERation:CMU:SUM2:CMU<SecAddr>:ENABLE` register.

When the event assigned to bit no. 0 of the `STATUS:OPERation:CMU:SUM1|2:CMU<SecAddr>` register occurs (e.g. when the input connector is overloaded in function group *RF Non Signalling*) the instrument generates a SRQ.

The same procedure can be applied to find out which event caused an SRQ:

- `STB?`
- Query `STAT:OPER:EVENT?`
- Query `STAT:OPER:CMU:SUM1|2:EVENT?` (function group, signalling mode)
- Query `STAT:OPER:CMU:SUM1|2:CMU1...15:EVENT?` (measurement)

The SRQ is the only possibility for the instrument to become active on its own. Each controller program should set the instrument such that a service request is initiated in the case of malfunction. The program should react appropriately to the service request.

Symbolic Status Event Register Evaluation

The examples for status register handling given in section [Service Request](#) on p. 5.24 are based on a step-by-step evaluation of the `STATUS:OPERation` register and its sub-registers. As a convenient alternative to this approach, the R&S® CMU provides commands for symbolic status event register evaluation. These commands are global (i.e. available in all function groups) and described in detail in Chapter 6. They organize and simplify the following actions:

| | |
|---|--|
| <code>STATUS:OPERation:EVENT:SADDRESS?</code> | Return the next secondary address and associated function group where an event was reported. |
| <code>STATUS:OPERation:SYMBOLic:ENABLE <Event_1>[,<Event_2>,...<Event_15>]</code> | Enable the events of the parameter list up to the status byte, i.e. set the corresponding bits in the <code>STATUS:OPERation:ENABLE</code> register and in the sub-registers <code>STATUS:OPERation:CMU:SUM1 2:ENABLE</code> and <code>STATUS:OPERation:CMU:SUM1 2:CMU<SecAddr>:ENABLE</code> , so that the events are reported in the status byte. <code><SecAddr></code> denotes the current secondary address, see also example in section Service Request on p. 5.24. |
| <code>STATUS:OPERation:SYMBOLic[:EVENT]?</code> | Return all events reported in the current function group. The event symbols listed with the bit assignment of the <code>STATUS:OPERation...</code> registers; for an example see Table 5-5 on page 5.22. |

An example program for symbolic status register evaluation is included in chapter 7 of this manual.

Serial Poll

In a serial poll, just as upon the command `"*STB?"`, the status byte of an instrument is queried. However, the query is made via interface messages and is thus clearly faster. The serial-poll method has already been defined in IEEE 488.1 and used to be the only standard possibility for different instruments to poll the status byte. The method also works for instruments which do not adhere to SCPI or IEEE 488.2.

The quick-BASIC command for executing a serial poll is `"IBRSP ()"`. The serial poll is mainly used to obtain a fast overview of the state of several instruments connected to the GPIB bus.

Parallel Poll

In a parallel poll, the controller uses a single command to request up to eight instruments to transmit one bit of information each on the data lines, i.e., to set the data line allocated to each instrument to a logical "0" or "1". In addition to the SRE register, which determines the conditions under which an SRQ is generated, there is a parallel poll enable register (PPE). This register is ANDed with the STB bit by bit, considering bit 6 as well. The results are ORed, the result is possibly inverted and then sent as a response to the parallel poll of the controller. The result can also be queried without parallel poll by means of the command `"*IST?"`.

The instrument first has to be set for the parallel poll using the quick-BASIC command `"IBPPC ()"`. This command allocates a data line to the instrument and determines whether the response is to be inverted. The parallel poll itself is executed using `"IBRPP ()"`.

The parallel poll method is mainly used to find out quickly which one of the instruments connected to the GPIB bus has sent a service request. To this effect, SRE and PPE must be set to the same value.

Query by Means of Commands

Each part of any status register can be read by means of queries. The individual commands are listed in Chapter 6. The returned value is always a number that represents the bit pattern of the register queried. This number is evaluated by the controller program.

Queries are usually used after an SRQ in order to obtain more detailed information on the cause of the SRQ.

Error Queue Query

Each error state in the instrument leads to an entry in the error queue. The entries of the error queue are detailed plain-text error messages that can be looked at in the ERROR menu via manual control or queried via the GPIB bus using command "SYSTem:ERRor?". Each call of "SYSTem:ERRor?" provides one entry from the error queue. If no error messages are stored there any more, the instrument responds with 0, "No error".

The error queue should be queried after every SRQ in the controller program as the entries describe the cause of an error more precisely than the status registers. Especially in the test phase of a controller program the error queue should be queried regularly since faulty commands from the controller to the instrument are recorded there as well.

Reset Values of the Status Reporting Systems

Table 5-7 comprises the different commands and events causing the status reporting system to be reset. None of the commands, except for *RST and SYSTem:PRESet influences the functional instrument settings. In particular, DCL does not change the instrument settings.

Table 5-7 Resetting instrument functions

| Event Effect | Switching on supply voltage | | DCL,SDC (Device Clear, Selected Device Clear) | *RST or SYSTem:PRESet | STATus:PRESet | *CLS |
|--|-----------------------------|-----|--|-----------------------|---------------|------|
| | Power-On-Status-Clear | | | | | |
| | 0 | 1 | | | | |
| Clear STB,ESR | — | yes | — | — | — | yes |
| Clear SRE,ESE | — | yes | — | — | — | — |
| Clear PPE | — | yes | — | — | — | — |
| Clear EVENT parts of the registers | — | yes | — | — | — | yes |
| Clear ENABLE parts of all OPERation-and QUES-Tionable registers, Fill ENABLE parts of all other registers with "1". | — | yes | — | — | yes | — |
| Fill PTRansition parts with "1" Clear NTRansition parts | — | yes | — | — | yes | — |
| Clear error queue | yes | yes | — | — | — | yes |
| Clear output buffer | yes | yes | yes | 1) | 1) | 1) |
| Clear command processing and input buffer | yes | yes | yes | — | — | — |

1) Every command being the first in a command line, i.e. immediately following a <PROGRAM MESSAGE TERMINATOR> clears the output buffer.

Measurement Control

The R&S® CMU offers a variety of measurements which are arranged in function groups and measurement groups. All measurements are controlled according to the same basic concepts. The benefit of this structure lies in the close analogy of all function groups. Commands belonging to different measurements have the same structure and syntax.

The following sections are devoted to the principles of measurement control:

- A measurement group can be split up into different subgroups by means of *applications* (optional, i.e. not available for every measurement group).
- Four different measurement states are defined; they can be accessed with a set of measurement control commands.
- The end of the measurement (or of a particular measurement stage) can be indicated by means of *the event reporting system*.
- Statistical settings comprising the repetition mode, statistic count (optional), stop condition (optional), and display mode (optional) control how the measurement is performed. The possible measurement states depend on the repetition mode.
- For many measurements it is possible to specify limits and perform a limit check.
- The current status and the results of the measurement can be queried in a systematic way.

Some measurements do not require the full scheme.

Measurement Groups and Applications

Applications are different measurements belonging to the same measurement group. Each application is assigned its own set of configuration parameters. With few exceptions (e.g. some tolerance values), all parameters assigned to the applications are independent from each other. Thus, applications effectively split up a measurement group into various independent subgroups which can be configured individually and serviced in parallel.

The benefit of this feature is that the results of an application will not become invalid when another application in the same measurement group is started.

Applications are generally identified by the third-level keyword in a command while the measurement group is identified by the second-level keyword.

Function group *RF (Non Signalling)* contains the following measurement groups and applications:

Table 5-10 RF measurement groups and applications

| Measurement | Description |
|-------------|--|
| WPOWer | Wide-band peak power measurement of the RF input signal. |
| RFANalyzer | Average RF power over a sweep, measured with different filters. |
| NPOWer | Measurement of the RF signal power using a narrow-band filter with variable bandwidth. |
| POWer | Measurement of the RF signal power as a function of time with statistical evaluation. |
| SPEctrum | Measurement of the RF frequency spectrum with statistical evaluation. |
| IQSLot | Measurement of the I and Q amplitudes in a sequence of consecutive measurement steps. |

| Measurement | Description |
|-------------|---|
| IQRecorder | Measurement of the I/Q data that the R&S CMU200/300 acquires with different IF filter settings. |

The following measurement groups and applications are defined in the *Audio* function group (with option R&S® CMU-B41):

Table 5-11 Audio measurement groups and applications

| Measurement | Description |
|-------------|---|
| AFANalyzer | DC and AC voltage and Total Harmonic Distortion and Noise of a single-tone audio signal. |
| MULTitone | Analysis of a composite audio signal consisting of up to 20 individual fixed-frequency tones with configurable frequency and level including limit check. |
| THD | Analysis of the AF power at the generator frequency (1st harmonic labeled d1) and at the 2 nd , 3 rd ...9 th harmonics and calculation of the Total Harmonic Distortion. |

Measurement Control Commands and States

Measurement control commands are used to switch over between the following four measurement states:

| | |
|-------------|--|
| OFF | measurement is switched off, no results available (after <i>STOP</i>) |
| RUN | measurement is running |
| STOP | measurement has been stopped, valid results are preserved |
| STEP | measurement has been interrupted after a statistics cycle (in repetition mode <i>Continuous</i> or <i>Counting</i> with <i>Stepping</i> mode set in addition). The next cycle must be launched with a <i>CONTInue</i> command. |

The *STOP* state corresponds to the *HLT* state indicated next to the softkeys controlling a measurement in manual operation. A *STEP* state is not defined in manual control.

The three measurement states *OFF*, *STOP*, and *STEP* can be mapped onto the standard SCPI state *IDLE*, the *RUN* state can be mapped onto the SCPI state *INITiated*. This and the relation between control commands and measurement states is shown in the following diagram:

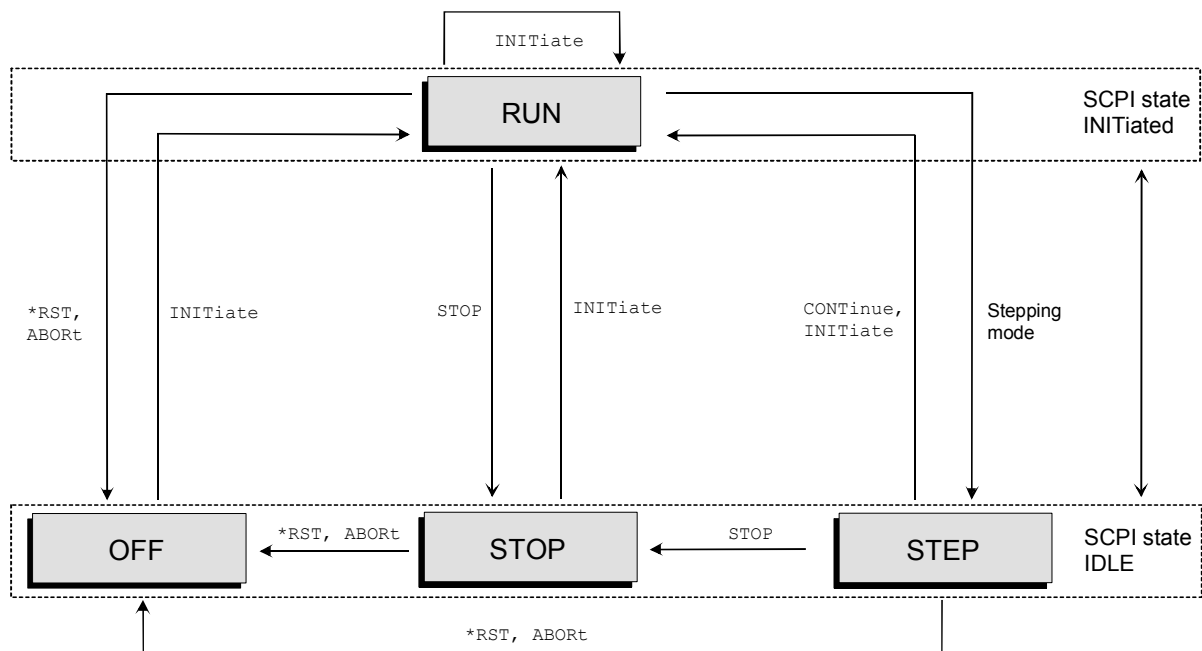

Fig. 5-7 Measurement states and control commands

The measurement control commands are supplemented by the measurement object, i.e.:

INITiate:<meas_obj> Starts a measurement in the repetition mode set via the `CONFigure:<meas_obj>:CONTrol:REPetition` command (single shot, continuous or counting mode, see section [Measurement Statistics](#) on page 5.36). The command resets the counters for the evaluation period and statistics (the latter is not used in RF measurements) to zero, furthermore, all measurement values are set invalid (*INV*).

As illustrated in [Fig. 5-7](#), `INITiate` can be called in any measurement state. If the measurement is already running (*RUN*), `INITiate` aborts (*ABORT*) and restarts a running measurement.

The measurement reserves all necessary hardware resources and switches into the *RUN* state. If the measurement can not be started due to a resource conflict it remains in the *OFF* state, and the measurement status returned by the `FETCH:<meas_obj>:STATus?` is *ERR*. At the same time the SCPI error `-213, Init ignored`, is generated.

Possible resources conflicts

- The RF connector is already allocated by another measurement or signal generator. The other measurement must be switched off first.
- Due to the method used for the analysis, two measurements can not be evaluated at the same time.

Overlapping execution

`INITiate` is implemented as an overlapped command. In contrast to SCPI specifications, the `*OPC` command (see Chapter 6, *Common Commands*) can not be applied together with the `INITiate` command. The *operation complete* bit (bit no. 0 in the event status register, ESR) is set immediately after the command sequence `INIT; *OPC`, i.e. as soon as the measurement is started and not after the end of the first evaluation period.

| | |
|--|--|
| | <p>The command <code>CONFigure:<meas_obj>:ERePorting <Event>, <Mode></code> represents a more flexible tool for generating a service request or setting the <i>operation complete</i> bit after the end of a measurement (see section Event Reporting on page 5.32).</p> |
| READ command | <p>Instead of <code>INITiate</code>, the <code>READ</code> command can be used to initiate a (single shot) measurement, see section Retrieving Measurement Results on page 5.38.</p> |
| <code>ABORt:<meas_obj></code> | <p>Aborts the current measurement immediately and switches over to the <i>OFF</i> state. All measurement values are set invalid (<i>INV</i>); the hardware resources are released for other measurements.</p> <p>As illustrated in Fig. 5-7, <code>ABORt</code> can be called in any measurement state.</p> |
| Sequential execution | <p><code>ABORt</code> is implemented as a sequential command. This means that <code>ABORt</code> is not complete until the measurement has released all of its resources and has changed to the <i>OFF</i> state.</p> |
| <code>STOP:<meas_obj></code> | <p>Stops (halts) the measurement as quickly as possible; i.e. after the end of the current evaluation period (or statistics cycle, if cycles comprising several evaluation periods are defined). The measurement changes to the <i>STOP</i> state such that all corresponding measurement values are kept unchanged. The hardware resources are retained.</p> <p>As illustrated in Fig. 5-7, <code>STOP</code> can be called in the measurement states <i>RUN</i> and <i>STEP</i>. If called in the <i>OFF</i> state the command causes an SCPI error <code>-221, Settings conflict</code>.</p> |
| Sequential execution | <p><code>STOP</code> is implemented as a sequential command. Execution of <code>STOP</code> is considered as complete as soon as the measurement state <i>STOP</i> is reached.</p> <p>The <code>STOP</code> command causes no events which are set by the event reporting system (see section Event Reporting on page 5.32). This means that a service request must be explicitly requested by an <code>*OPC</code> command.</p> |
| <code>CONTinue:<meas_obj></code> | <p>Resumes the measurement for the next measurement evaluation period and changes to the <i>RUN</i> state.</p> <p>As illustrated in Fig. 5-7, <code>CONTinue</code> can be called in the measurement states <i>STOP</i> and <i>STEP</i>. If the previous measurement has been terminated (the measurement status returned by the <code>FETCh:<meas_obj>:STATus?</code> is <i>RDY</i>), <code>CONTinue</code> restarts the measurement and resets the counters for the evaluation period and statistics (the latter is not used for RF measurements) to zero.</p> <p>In the other measurement states the command causes an SCPI error <code>-221, Settings conflict</code>.</p> |

Overlapping execution `CONTInue` is implemented as an overlapping command like `INITiate`. As a consequence, `*OPC` can not be used together with `CONTInue`.

Stepping mode

The stepping mode determines whether a measurement in the *counting* or *continuous* mode (see section [Measurement Statistics](#) on page 5.36) is interrupted after each evaluation period (or each statistics cycle, if cycles comprising several evaluation periods are defined) or not. This mode is set via the `<Stepmode>` parameter of the `CONFigure:<meas_obj>:CONTrol:REPetition CONTInuous | 1 ... 10000, <StopCondition>, <Stepmode>` command:

`<Stepmode> = STEP` The measurement is interrupted (\Rightarrow measurement state *STEP*) after each evaluation period, and the event reporting system (see p. 5.32) is invoked. The next measurement cycle must be started with the `CONTInue:<meas_object>` command.

`<Stepmode> = NONE` The measurement runs according to its repetition mode. Event reporting is invoked only when the measurement stops (status = *RDY*).

Note: *STEP* can be set in all repetition modes (single shot, continuous, counting). For a single shot measurement, which is always stopped after one evaluation period, the stepping mode has no effect.

In function group *RF Non Signalling*, `<meas_obj>` can stand for any of the measurement objects `POWer` and `SPECTrum`.

Note: Some measurements rely upon the same system resources and cannot be performed simultaneously. The R&S® CMU provides a mechanism to decide whether conflicting measurements are persistent or releasable; see section [Task Priority Management](#).

Event Reporting

The event reporting system specifies in which way the R&S® CMU reports that a measurement or a measurement step has been correctly terminated, i.e., that the measurement status *STEP* or *RDY* has been reached. Event reporting is configured for each measurement group individually by means of the command:

```
CONFigure:<meas_obj>:EREPorting SRQ | SOPC | SRSQ | OFF
```

The parameters have the following meaning:

SRQ Service request. A service request is generated (i.e. bit no. 6 (RQS/MSS) of the status byte (STB) is set) whenever the measurement status *STEP* or *RDY* is reached (see section [Service Request](#) on page 5.24).

SOPC Single operation complete. The *operation complete* bit (bit no. 0 in the event status register) is set whenever the measurement status *STEP* or *RDY* is reached (see section [Status Reporting System](#) on page 5.16).

SRSQ A service request is generated and the *operation complete* bit is set.

OFF No special action is taken when the measurement status *STEP* or *RDY* is reached.

Note: No action is taken if the *STOP* state is reached due to an explicit *STOP* command.

Symbolic Measurement Ready Evaluation:

If event reporting is enabled (i.e. `CONFigure:<meas_obj>:EREPorting` is not set to `OFF`), each measurement that reaches the *STEP* or *RDY* status causes an entry in the *measurement queue*. The measurement queue can be queried by means of the `SYSTEM:MQUeue[:COMplete]<spec>?` commands described in Chapter 6. Two different specifiers are provided:

`<spec> = [:LIST]` Returns the complete list of all ready measurements and reset all entries in the measurement queue to *NONE*.

`<spec> = :ITEM` Returns the next ready measurement in the list and reset the corresponding entry in the measurement queue to *NONE*.

Symbolic measurement ready evaluation is in order, e.g. to avoid inconsistencies when a `FETCH...?` command is used to retrieve measurement results (see section [Retrieving Measurement Results](#) on page 5.38).

Measurement Status

The status of the current measurement can be queried by means of the following command:

FETCh status FETCh:<meas_obj>:STATus?

Returns the current status of the measurement. The FETCh... command can be used as well to poll the progress of a measurement. The response to the FETCh... query has the format <Status>, <Counting_No>, <Statistic_No>.

<Status> The first parameter in the response reports on the current status of the measurement. The measurement status returned is closely linked to the four measurement states described in section [Measurement Control Commands and States](#) on page 5.29 ff.:

OFF measurement in the *OFF* state after *RST or ABORT
RUN measurement in the *RUN* state after INITiate, CONTinue, or READ
STOP measurement in the *STOP* state after STOP (stopped explicitly)
STEP measurement in the *STEP* state due to <Stepmode> = STEP, valid measurement results
RDY measurement in the *STOP* state because stopped according to the repetition mode and stop condition set.
ERR measurement in the *OFF* state because it could not be started with INITiate or READ for lack of resources, e.g. because the RF connectors were already in use by another measurement.

<Counting_No> The second parameter in the response returns the current value of the statistics counter (the number of the current statistics cycle) if the measurement is performed in the *Counting* mode:

0 ... 10000 number of the current statistics cycle
NONE no counter for statistics cycles used, i.e. a repetition mode other than *Counting* is set.

<Statistic_No> The third parameter in the response returns the number of the current *evaluation period* (e.g. a timeslot in digital network tests) within a statistics cycle. In some measurements this counter is not used (response *NONE*).

Generator Control

The commands used for control of the R&S® CMU's RF and AF signal generators are analogous to the measurement control commands explained on page 5.29. The generators are in one of the following two generator states:

| | |
|-------------|--|
| OFF | generator switched off, resources released |
| RUN | generator running |
| STOP | generator stopped, resources reserved |

The **RUN** state corresponds to the status indication **ON** in the **RF generator** softkey (see section *Analyzer/Generator Menu* in Chapter 4).

The relation between generator commands and generator states is shown in the following diagram:

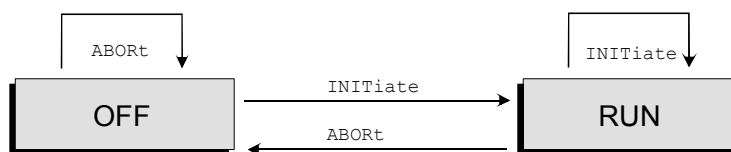

Fig. 5-8 Generator states and control commands

Generator control commands are recognized by the second-level keyword `RFGenerator` or `AFGenerator`. The generator control commands behave as follows:

INITiate:
RFGenerator Starts the generator, reserves all necessary hardware resources and changes to the generator state **RUN**.

INITiate:
AFGenerator... As illustrated in Fig. 5-8, **INITiate** can be called in any generator state. If the generator is already running (**RUN**), **INITiate** has no effect.

If the generator cannot be started due to a resource conflict it remains in the **OFF** state, and the measurement status returned by the `FETCH:<meas_obj>:STATUS?` is **ERR**. At the same time the SCPI error `-213, Init ignored`, is generated.

Possible resource conflicts The RF connector is already allocated by another generator. The other generator must be switched off first.

Sequential execution **INITiate** is implemented as a sequential command. The `*OPC` command (see Chapter 6, *Common Commands*) can be applied together with the **INITiate** command.

ABORt:
RFGenerator Switches the generator off, releases the hardware resources for other generators, and changes to the generator state **OFF**.

ABORt:
AFGenerator... As illustrated in Fig. 5-8, **ABORt** can be called in any generator state. If the generator is switched off (**OFF**), **ABORt** has no effect.

Sequential execution **ABORt** is implemented as a sequential command. The command is not terminated until the generator is completely switched off.

Note: In some function groups (e.g. in function group **Audio**), several RF or AF generators can be used. Generators relying upon the same system resources cannot be switched on simultaneously. The R&S® CMU provides a mechanism to decide whether conflicting generators are persistent or releasable; see section [Task Priority Management](#).

Generator Status

The generator status can be queried by means of the `FETCh...?` command:

| | |
|----------------------|---|
| FETCh command | <p><code>FETCh:<meas_obj>:STATus?</code></p> <p>Returns the current generator status. The <code>FETCh...</code> command can be used to poll the generator status. The <code>FETCh...</code> query returns one of the following generator states:</p> <p>OFF generator is in the <i>OFF</i> state (default status after <code>*RST</code> or due to <code>ABORT...</code> command)</p> <p>RUN generator running (<i>RUN</i> state after <code>INITiate...</code> command)</p> <p>STOP generator stopped (after <code>STOP...</code> command)</p> <p>ERR generator is in the <i>OFF</i> state because it could not be started with an <code>INITiate...</code> command for lack of resources (e.g. the RF connector is already in use by another generator)</p> |
|----------------------|---|

Measurement Statistics

The basic evaluation period for `POWer` and `SPECTrum` measurements (function group RF) corresponds to a sweep (see also Chapter 3, section *General Settings*). In *Audio* measurements, the evaluation period corresponds to the time until the system has settled and a valid result is available.

Together with the *Statistic Count*, the *Repetition Mode* defines how many evaluation periods are measured if the measurement is not stopped explicitly (measurement control commands `STOP...`, `ABORT...`) or by a limit failure. With remote control the three repetition modes *Single Shot*, *Continuous* and *Counting* are available (*Counting* is not available in manual control).

In `POWer` and `SPECTrum` measurements, different traces corresponding to the result in the current evaluation period, the maximum, minimum, or average over a set of evaluation periods (bursts) are determined. These results can be queried independently.

Table 5-13 Statistics in remote control

| Setting | Description | Command |
|---------------------------------------|--|--|
| Statistic Count | Integer number of evaluation periods forming one statistics cycle. | <code>CONFigure:<meas_obj>:CONTRol:STATistics 1 ... 1000 NONE</code> (in RF: <code><meas_obj> = POWer SPECTrum</code>) |
| Repetition mode Single Shot | The measurement is stopped after one statistics cycle. | <code>CONFigure:<meas_obj>:CONTRol:REPetition SINGleshot, <StopCondition>, <Stepmode></code> |
| Continuous | The measurement is continued until stopped explicitly or by a limit failure. Results are valid after one evaluation period and updated after the next evaluation period has been terminated. Average results are calculated according to the rules given in chapter 3. | <code>CONFigure:<meas_obj>:CONTRol:REPetition CONTinuous, <StopCondition>, <Stepmode></code> |
| Counting | Repeated single shot measurement with a definite number of evaluation periods. The stepping mode (<code><Stepmode> = STEP NONE</code>) determines whether or | <code>CONFigure:<meas_obj>:CONTRol:REPetition 1 ... 1000, <StopCondition>, <Stepmode></code> A counting measurement with 1 evaluation period is equivalent to a single shot measurement.. |

| Setting | Description | Command |
|---------------|---|--|
| | not the measurement is stopped after each evaluation period or not, see section Measurement Control Commands and States on page 5.29. | |
| Traces | <p>The specifiers [CURRent:], MAXimum, MINimum, and AVERage denote the traces for the current evaluation period, the maximum, minimum, extreme value, or average of a set of evaluation periods. They correspond to the <i>Display Mode</i> set in the measurement configuration menus.</p> <p>In general all four traces are evaluated during the measurement. They are selected via the specifiers used as last keywords in the READ..., FETCh... or SAMPlE... queries.</p> | <p>Measurement results: READ:ARRay:<meas_obj>:<disp>? READ:SUBarrays:<meas_obj>...<disp>? ...</p> <p>Limit matching: CALCULATE:ARRay:<meas_obj>:<disp>: MATChing:LIMit? </p> <p><disp> = [:CURRent] :AVERage :MAXimum MINimum</p> |

Note: Some measurement groups (e.g. the *WPOWER* measurement in function group *RF*) use simplified statistical settings where the *Statistic Count* is always 1. It is still possible to select different repetition modes for these measurements.

Specifying Limits

Limit checks are provided for the MULTitone measurement (with option CMU-B41, *Audio Generator and Analyzer*). The following table gives an overview of the types of limits and possible results of a limit check.

Table 5-15 Limits and limit check for MULTitone measurements

| | Description | Command |
|--------------------|--|---|
| Limit lines | Tolerance template for up to 20 test tones (alternatively, it is possible to define each limit separately; see Chapter 6). | CONFigure:MULTitone:<Channel>:LIMit: LINE:ASYMmetric:<Spec.> <Channel> = AF1Channel AF2Channel <Spec.> = UPPer LOWer for upper or lower limits. |
| Limit check | The command on the right side performs the limit check and returns the results for all test tones (alternatively, it is possible to retrieve each result separately; see Chapter 6). | CALCulate[:SCALar]:MULTitone:<Channel>: :MATChing:LIMit? |
| | Possible results of the limit check are listed on the right side. | NMAU not matching, underflow NMAL not matching, overflow INV measured value invalid OK no limit failure |

Retrieving Measurement Results

General command structure The results of a measurement can be retrieved by means of the `FETCH`, `SAMPLE` or `READ` query. All three commands have the same structure:

```

FETCH<type>:<meas_obj>[:RESult]<spec>?
SAMPle<type>:<meas_obj>[:RESult]<spec>?
READ<type>:<meas_obj>[:RESult]<spec>?

```

The literals written in angle brackets have the following meaning:

`<type>` Measurement trace (`:ARRAY`), scalar values (`:SCALAR`) can be retrieved in the network tests; see the relevant operating manuals.

To limit the number of commands and simplify the program syntax, all scalar results determined in a measurement are generally read out with a single command. They are returned as a list of values separated by commas.

The length of the arrays depends on the measurement group and possibly on the configuration settings; see also *Subarrays* paragraph below.

`<meas_obj>` Measurement group (measurement object): `POWER` | `SPECTRUM` are used in *RF Non Signalling* mode.

`<spec>` `[:CURRENT]` current evaluation period, other statistical traces can be retrieved in the network tests.

Subarrays Arrays generally consist of a large number of values representing the measurement trace over the whole time or frequency range. With the `SUBarrays` commands, the R&S® CMU provides a flexible tool for handling large amounts of data. These commands restrict a measurement to up to 32 subranges where either all measurement results or a single statistical value can be read out.

Subarray configuration The subarrays are configured with the following commands:

```

CONFigure:SUBarrays:<meas_obj> <Mode>, <Start>, <Samples>
                                     {,<Start>, <Samples>}

```

`<meas_obj>` Measurement group (measurement object). For examples refer to the manuals for the network tests.

`<Mode>` Statistics mode for **all** subranges. The following parameters can be set:

`ALL` Return all measurement values (the number of values in every subrange is given by the `<Samples>` parameter).

`ARITHmetical` Return the arithmetical mean value of the results in every subrange.

`MINimum` Return the minimum of the results in every subrange.

`MAXimum` Return the maximum of the results in every subrange.

`IVAL` Return a single measurement value corresponding to the abscissa value `<Start>`. If `<Start>` is located between two test points with valid results then the result is calculated from the results at these two adjacent test points by linear interpolation. Ignore the `<Samples>` parameter.

| | |
|----------|---|
| PAVG | Return the arithmetic mean value of the results in every subrange. This mode is appropriate for average power measurements. It may produce misleading results, e.g. for quantities with alternating sign. |
| XMINimum | Return the minimum of the results in every subrange, preceded by the corresponding x-axis value. For n subranges, 2*n values are returned (x1, y1, y2, y2 ... xn, yn). If the minimum in a subrange is invalid, two NANs (NAN, NAN) are returned. |
| XMAXimum | Return the minimum of the results in every subrange, preceded by the corresponding x-axis value. See XMINimum above. |

<Start> Start of current range (time or frequency or channel number).
 <Samples> Number of samples in current range.

The subranges may overlap but must be within the total range of the <meas_obj>. Test points outside this range are not measured (result NAN) and do not enter into the ARITHmetical, MINimum and MAXimum values.

By default, only one range corresponding to the total measurement range is used and all measurement values are returned.

Subarray results are retrieved by means of FETCh, SAMPlE or READ queries, with :SUBarrays inserted as a second-level keyword:

```
FETCh:SUBarrays<type>:<meas_obj>[:RESult]<spec>?
SAMPlE:SUBarrays<type>:<meas_obj>[:RESult]<spec>?
READ:SUBarrays<type>:<meas_obj>[:RESult]<spec>?
```

In the default subarray configuration, these commands are identical with the FETCh, SAMPlE or READ queries described above (i.e. all measurement results are read out).

FETCh command

```
FETCh<type>:<meas_obj>[:RESult]<spec>?
```

Retrieves the latest valid measurement results.

If the FETCh query is used immediately after an INITialize... command, the first evaluation period is terminated before the query is executed so that a valid result can be acquired. If called up repeatedly after termination of the first evaluation period, the FETCh query may return the same results several times until they have been updated after the next period.

A FETCh returns the results without interaction with the measurement (unsynchronized query). In some cases this may cause inconsistent results to be read so that the SAMPlE command should be used while the measurement is in the RUN state.

Measurement states According to the definition given above the effect of the FETCh query depends on the measurement status and the history of the measurement:

| Status | Valid Results? | Effect of FETCh...? |
|--------|----------------|--|
| ≠ OFF | Yes | Returns the current results. |
| OFF | No | Generates an SCPI error -230, <i>Data corrupt or stale</i> . This is |

| Status | Valid Results? | Effect of <code>FETCH</code> . . . ? |
|--------|----------------|---|
| | | why <code>FETCH</code> should not be used while the measurement is in the <i>OFF</i> state. |
| RUN | No | Waits until valid results are available and returns these results. |
| STOP | No | Generates an SCPI error <code>-230, Data corrupt or stale</code> . This scenario occurs, e.g. if the measurement is stopped explicitly before the first evaluation period has been terminated. |

SAMPLE command

`SAMPLE<type>:<meas_obj>[:RESult]<spec>?`

Retrieves the results of the current evaluation period. In single shot measurements, `SAMPLE` is equivalent to `READ`.

In a *continuous* measurement, or in *counting* mode (see *repetition mode* in section [Measurement Statistics](#) on p. 5.36 ff.), `SAMPLE` is executed only after termination of the current evaluation period. This implies that a single measurement result can be returned only once by a `SAMPLE` query; if called up repeatedly, `SAMPLE` will return the result of subsequent evaluation periods.

Due to this behavior, the `SAMPLE` query is suitable for monitoring the progress of *continuous* measurements in time. Multiple identical results, which might be returned by repeated `FETCH` commands, are avoided.

A `SAMPLE` query returns the results after interacting with the measurement (synchronized query). This means that only valid results are returned, inconsistencies are avoided.

Measurement states According to the definition given above the effect of the `SAMPLE` query depends on the measurement status and the history of the measurement:

| Status | Valid Results? | Effect of <code>SAMPLE</code> . . . ? |
|-------------------|----------------|---|
| STOP RDY STEP | Yes | Returns the current results. In this case, the <code>SAMPLE</code> command is equivalent to the <code>FETCH</code> command. |
| OFF | No | Generates an SCPI error <code>-230, Data corrupt or stale</code> . This is why <code>SAMPLE</code> should not be used while the measurement is in the <i>OFF</i> state. |
| RUN | Yes No | Waits until the end of the current evaluation period, returns the results, and resumes the measurement (unless the current evaluation period is the last to be measured). |
| STOP | No | Generates an SCPI error <code>-230, Data corrupt or stale</code> . This scenario occurs, e.g. if the measurement is stopped explicitly before the first evaluation period has been terminated. |

READ command `READ<type>:<meas_obj>[:RESult]<spec>?`

Starts a new measurement, terminates the measurement and returns the results after one single shot. The `READ...?` query is equivalent to:

```
ABORt...;
INITiate...;
FETCh...?
```

The `READ` command preserves all configurations (such as event reporting, stop condition, statistics count...). `READ` initiates a measurement which is terminated after one single shot (\Rightarrow measurement state *STOP*, status *RDY*; if an error occurred, the status is *ERR*). However, it does not affect the repetition mode setting itself.

In case of no error (status *RDY*), the measurement can be continued by means of the `CONTInue` command. It will be performed with the repetition mode set before `READ` was executed.

Diagrammatic Overview of Measurement Control

The commands used to configure and control the measurements, to query the status of the measurement, and to retrieve the measurement results are closely linked to the settings for the repetition mode and stop condition. The various scenarios are most easily explained by means of a graphical representation of the measurements.

Single Shot Measurements

Stop condition: NONE

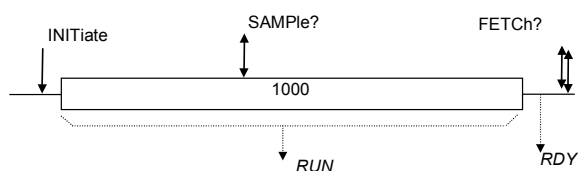

A single shot measurement comprising 1000 evaluation periods with stop condition none is performed. The measurement is started with the `INITiate` command. The results can be queried using the `SAMPle...?` (status *RUN* or *RDY*) or `FETCh...?` (status *RDY*) commands. The measurement is configured via:

```
CONFigure:<meas_obj>:CONTRol <type>,1000
CONFigure:<meas_obj>:CONTRol:REPetition
    SINGleshot,NONE,<Stepmode>
```

The `<Stepmode>` parameter has no effect.

Stop condition: SONerror

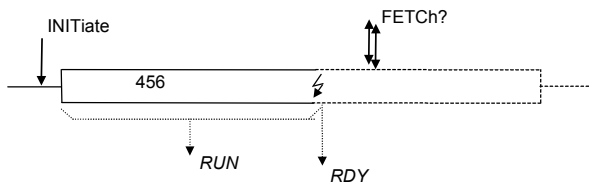

A single shot measurement comprising 1000 evaluation periods with stop condition SONerror is performed. The measurement is started with the INITiate command and stopped before the end of the statistics cycle. The results can be queried using the SAMPlE...? (status RUN or STOP) or FETCh (status STOP) commands. The number of bursts measured can be queried using the FETCh:<meas_obj>:STATus? command. The measurement is configured via:

```
CONFigure:<meas_obj>:CONTRol <type>,1000
CONFigure:<meas_obj>:CONTRol:REPetition
    SINGleshot,SONerror
    <Stepmode>
```

The <Stepmode> parameter has no effect.

Counting Measurements

Stop condition: NONE

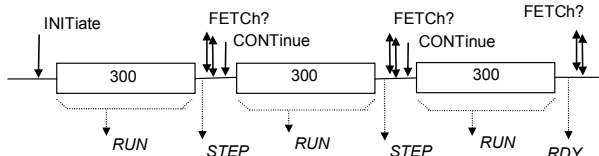

A counting measurement comprising 3 counts of measurements, each about a statistics cycle of 300 evaluation periods, is performed. The measurement is started with the INITiate command. The results can be queried using the SAMPlE...? (status RUN, STEP or RDY) or FETCh...? (status STEP or RDY) commands. The measurement is configured via:

```
CONFigure:<meas_obj>:CONTRol <type>,300
CONFigure:<meas_obj>:CONTRol:REPetition
    3,NONE,<Stepmode>
```

The STEP status occurs only if the stepping mode is set (<Stepmode> = STEP). In this case, the next cycle must be restarted via the CONTInue command.

Stop condition: SONerror

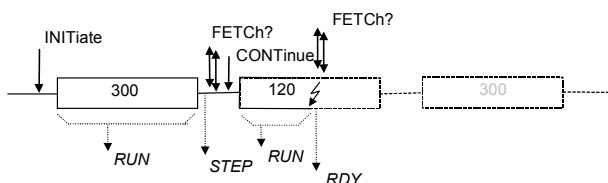

A counting measurement comprising counts of measurements, each about a statistics cycle of 300 evaluation periods, is performed. The measurement is started with the INITiate command. The results can be queried using the SAMPlE...? (status RUN, STEP or RDY) or FETCh...? (status STEP or RDY) commands. The measurement is configured via:

```
CONFigure:<meas_obj>:CONTRol <type>,300
CONFigure:<meas_obj>:CONTRol:REPetition
    3,SONerror,<Stepmode>
```

The STEP status occurs only if the stepping mode is set (<Stepmode> = STEP). In this case, the next cycle must be restarted via the CONTInue command.

Continuous Measurements

Statistics cycles, stop condition: NONE

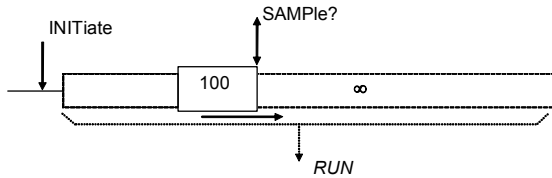

A continuous measurement with statistics cycles consisting of 100 bursts each is performed. Average results are calculated according to the rules given in chapter 3. The measurement is started with the `INITiate` command. Results can be queried using the `SAMPlE...?` command (status `RUN`). During the measurement `FETCh...?` may return inconsistent results. The measurement is configured via:

```
CONFigure:<meas_obj>:CONTRol <type> 100
CONFigure:<meas_obj>:CONTRol:REPetition
    CONTInuous,NONE,NONE
```

Statistics cycles, stop condition: SONerror

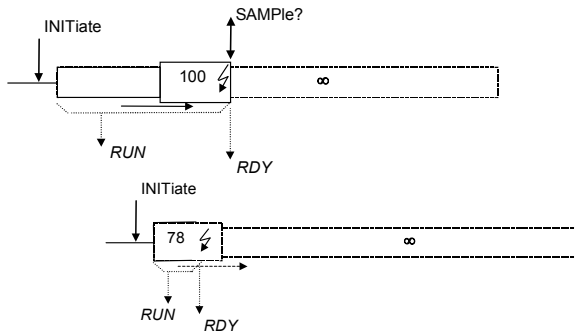

A continuous measurement with statistics cycles consisting of 100 evaluation periods each is performed. The measurement is started with the `INITiate` command. Results can be queried the `SAMPlE...?` command (status `RUN`, `STOP`). During the measurement `FETCh...?` may return inconsistent results. If the stop condition is met during the first statistics cycle no valid result is available. The measurement is configured via:

```
CONFigure:<meas_obj>:CONTRol <type> 100
CONFigure:<meas_obj>:CONTRol:REPetition
    CONTInuous,SONerror,NONE
```

Statistics off, stop condition: NONE

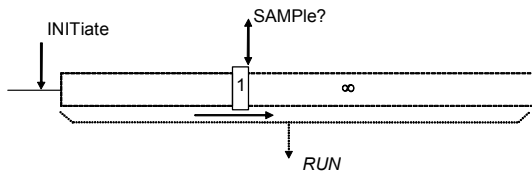

A continuous measurement is performed. No statistics cycles are defined. The measurement is started with the `INITiate` command. Results can be queried using the `SAMPlE...?` command (status `RUN`). During the measurement `FETCh...?` may return inconsistent results. The measurement is configured via:

```
CONFigure:<meas_obj>:CONTRol <type> OFF
CONFigure:<meas_obj>:CONTRol:REPetition
    CONTInuous,NONE,NONE
```

Statistics off, stop condition: SONerror

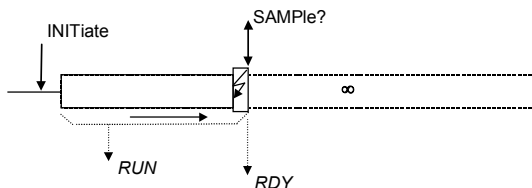

A continuous measurement is performed. No statistics cycles are defined. The measurement is started with the `INITiate` command. Results can be queried the `SAMPlE...?` command (status `RUN`, `STOP`). During the measurement `FETCh...?` may return inconsistent results. The measurement is configured via:

```
CONFigure:<meas_obj>:CONTRol <type> OFF
CONFigure:<meas_obj>:CONTRol:REPetition
    CONTInuous,SONerror,NONE
```

Note: The stepping mode can be set for continuous measurements as well (Parameter `<Step-mode>=STEP`, see section [Counting Measurements](#) on page 5.42). In this case, the system takes up the `STEP` status after each statistics cycle. It can be relaunched via the `CONTInue` command.

Task Priority Management

The Universal Radio Communication Tester R&S CMU is a modular platform supporting a wide range of network standards with specific, preconfigured measurements and generators. For the remainder of this section, measurements and generators are both termed *Objects*.

In general, the testers are capable of running several objects in parallel. E.g. the GSM900 RF generator can be used to establish a connection to a mobile station under test, and to perform a *Receiver Quality* and a *Modulation* measurement simultaneously. Conflicts between different objects may occur if they rely upon the same system resources.

The *Task Priority Management* parameter in the *Setup – Remote* tab provides a control mechanism for conflicting objects, leaving it up to the user’s choice whether a running object should persist, or whether it should be released when the next object is initiated.

Persistent Objects

If *Task Priority Management* is disabled, all objects are persistent. This means that a running object (measurement state *RUN*) has priority over any new object that is in conflict with the running object. If an attempt is made to initiate a new object, the CMU generates the SCPI error –213, *Init ignored*. The old object continues to be executed, whereas the new object remains in the *OFF* state.

To start a new object, it is necessary to abort the running object explicitly or wait until valid results are available and the measurement status is *RDY* (for measurement objects only; see example 2 on p. 5.45).

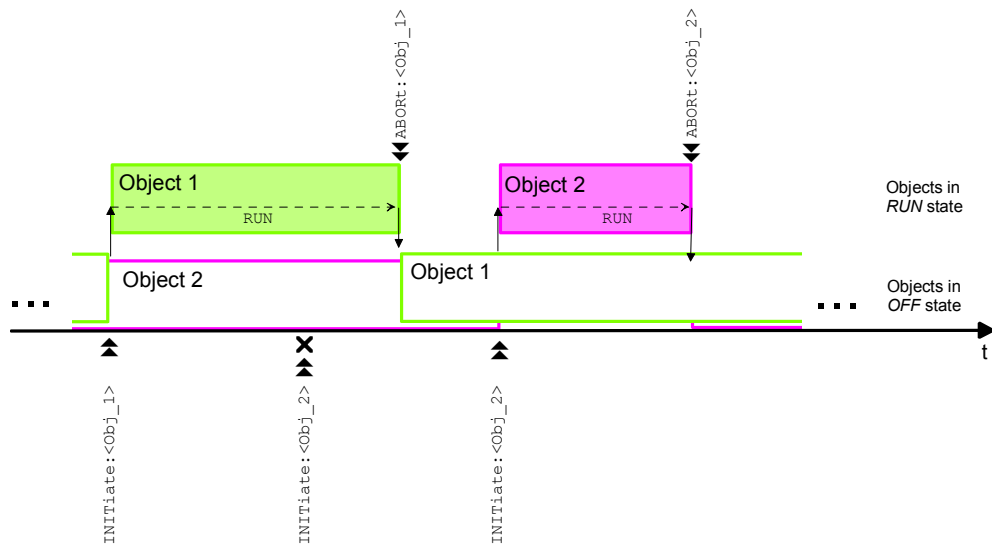

Releasable Objects

If *Task Priority Management* is enabled, all objects are releasable. This means that any new object has priority over a running object (or several running objects, measurement state *RUN*) that is in conflict with the new object. If a new object is initiated, the CMU aborts the running object. The old object enters the *OFF* state, whereas the new object enters the *RUN* state.

A new object can be started without delay irrespective of the instrument state.

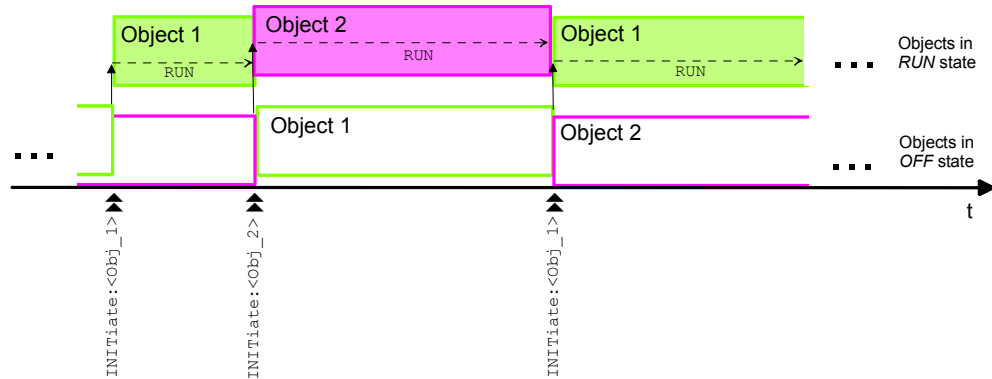

Selection Criteria

Whether to attribute the priority to running or to new objects depends on the measurement task and the preferences of the programmer, see examples below.

- The persistent object scheme ensures that a running object can not be aborted by new objects. A running measurement is generally continued, at least until valid results are available and the measurement status becomes *RDY*. A generator signal is not switched off; in *Signalling* test modes, release of the connection because of a missing RF signal from the CMU is avoided.
- The releasable object scheme ensures that any new object can be started without delay irrespective of the instrument state. The instrument always obeys the last statement in the command sequence; the instrument state is predictable.

Examples

The following examples illustrate the different behavior of the instrument for the two task priority schemes. The remote control commands are taken from the *GSM900-MS Non Signalling* and *GSM900-MS Signalling* function groups.

1. Conflicting generator objects

Consider the *RF Generator* in *Non Signalling* mode and the *BS Signal* generator in *Signalling* mode. The two generator objects are in conflict. The generator states can be queried by means of `FETCh:RFGenerator:STATUS?` (*Non Signalling*) and `SIGNalling:STATe?` (*Signalling*), using the appropriate secondary addresses.

| Command Sequence | Current Scheme: Persistent Objects | | Alternative Scheme: Releasable Objects | |
|--|------------------------------------|--|--|--|
| | Object 1: RF Generator | Object 2: Signalling Generator (BS Signal) | Object 1: RF Generator | Object 2: Signalling Generator (BS Signal) |
| *RST | OFF | OFF | OFF | OFF |
| Sec_Addr. 1: INITiate:RFGenerator | RUN | OFF | RUN | OFF |
| Sec_Addr. 2: PROCedure:SIGNalling:ACTion SON | RUN | OFF (⇒ Init ignored) | OFF | SON |

2. Conflicting measurement objects, state RDY

Assume that two measurements <Meas_1> and <Meas_2> are in conflict. The status of the measurements can be queried by means of FETCh:<Meas_1>:STATUs? and FETCh:<Meas_2>:STATUs?. If <Meas_1> is terminated using a FETCh:<Meas_1>? command before <Meas_2> is initiated, then the two task priority schemes are equivalent.

| Command Sequence | Current Scheme: Persistent Objects | | Alternative Scheme: Releasable Objects | |
|--|------------------------------------|------------------------|--|------------------------|
| | Object 1: < Meas_1> | Object 2: < Meas_2> | Object 1: < Meas_1> | Object 2: < Meas_2> |
| *RST | OFF | OFF | OFF | OFF |
| INITiate:<Meas_1> FETCh:<Meas_1>? | RUN RDY | OFF OFF | RUN RDY | OFF OFF |
| INITiate:<Meas_2> FETCh:<Meas_2>? | OFF OFF | RUN RDY | OFF OFF | RUN RDY |

3. Conflicting measurement objects, state RUN

Assume that two measurements <Meas_1> and <Meas_2> are in conflict. The status of the measurements can be queried by means of FETCh:<Meas_1>:STATUs? and FETCh:<Meas_2>:STATUs?.

| Command Sequence | Current Scheme: Persistent Objects | | Alternative Scheme: Releasable Objects | |
|-----------------------|------------------------------------|------------------------|--|------------------------|
| | Object 1: < Meas_1> | Object 2: < Meas_2> | Object 1: < Meas_1> | Object 2: < Meas_2> |
| *RST | OFF | OFF | OFF | OFF |
| INITiate:<Meas_1> | RUN | OFF | RUN | OFF |
| INITiate:<Meas_2> | RUN | OFF (⇒ Init ignored) | OFF | RUN |
| FETCh:<Meas_2>? | RUN | OFF (results: NAN) | OFF | RDY (valid results) |
| FETCh:<Meas_1>? | RDY (valid results) | OFF | OFF (results: NAN) | RDY |

4. Conflicting generator objects with measurements

Assume that <Signalling_i> and <Meas_i> (i = 1, 2) denote the BS Signal generator and a measurement in function groups GSM900 and GSM1800, respectively. The two generator objects are in conflict, and so are the measurement objects which we assume to rely upon the generator signals.

The generator states can be queried by means of SIGNalling:STATE? (*Signalling*), using different secondary addresses. The status of the measurements can be queried by means of FETCh:<Meas_1>:STATUs?, again using the appropriate secondary addresses.

| Command Sequence | Current Scheme: Persistent Objects | | | |
|--|------------------------------------|----------|-----------------------|----------------------|
| | <Signalling_1> | <Meas_1> | <Signalling_2> | <Meas_2> |
| *RST | SOFF | OFF | SOFF | OFF |
| ↓ Sec_Addr. 1: PRoCedure:SIGNalling:ACTion SON | SON | OFF | SOFF | OFF |
| ↓ Sec_Addr. 1: INITiate:<Meas_1> | SON | RUN | SOFF | OFF |
| ↓ Sec_Addr. 1: PRoCedure:SIGNalling:ACTion MTC | CEST | RUN | SOFF | OFF |
| ↓ Sec_Addr. 2: PRoCedure:SIGNalling:ACTion SON | CEST | RUN | SOFF (⇒ Init ignored) | OFF |
| ↓ Sec_Addr. 2: INITiate:<Meas_2> | CEST | RUN | SOFF | OFF (⇒ Init ignored) |

| Command Sequence | Alternative Scheme: Releasable Objects | | | |
|--|--|----------|----------------|----------|
| | <Signalling_1> | <Meas_1> | <Signalling_2> | <Meas_2> |
| *RST | SOFF | OFF | SOFF | OFF |
| ↓ Sec_Addr. 1: PRoCedure:SIGNalling:ACTion SON | SON | OFF | SOFF | OFF |
| ↓ Sec_Addr. 1: INITiate:<Meas_1> | SON | RUN | SOFF | OFF |
| ↓ Sec_Addr. 1: PRoCedure:SIGNalling:ACTion MTC | CEST | RUN | SOFF | OFF |
| ↓ Sec_Addr. 2: PRoCedure:SIGNalling:ACTion SON | SOFF | OFF | SON | OFF |
| ↓ Sec_Addr. 2: INITiate:<Meas_2> | SOFF | OFF | SON | RUN |

Contents

| | |
|---|-------------|
| 6 Remote Control – Commands | 6.1 |
| Special Terms and Notation | 6.1 |
| Common Commands | 6.4 |
| Base System Commands | 6.8 |
| System Commands | 6.8 |
| Status Commands..... | 6.9 |
| Symbolic Status Event Register Evaluation | 6.12 |
| Setup – Basic Device Settings | 6.13 |
| Subsystem Remote..... | 6.13 |
| Subsystem Communicate | 6.16 |
| Subsystem Options | 6.17 |
| Subsystem Time | 6.18 |
| Subsystem MISC | 6.19 |
| Subsystem TCPip (TCP/IP Addressing) | 6.20 |
| Subsystem GTRMode (Local to Remote Switchover) | 6.25 |
| Subsystem MQUeue | 6.25 |
| Reset of Function Groups | 6.26 |
| Remote Report – Subsystem TRACe | 6.27 |
| File Manager – System MMEMory | 6.28 |
| Synchronization | 6.33 |
| Display Settings..... | 6.36 |
| General Purpose Commands (All Function Groups) | 6.37 |
| Subsystem Options | 6.37 |
| Configuration File Management – System MMEMory..... | 6.37 |
| Partial Reset..... | 6.38 |
| Symbolic Status Event Register Evaluation | 6.38 |
| RF Measurements | 6.40 |
| Connection Control..... | 6.40 |
| Subsystem LEVel (Input Level)..... | 6.40 |
| Subsystem TRIGger (Trigger Mode)..... | 6.41 |
| Subsystem RFANalyzer... (Analyzer Settings)..... | 6.43 |
| Measurement Control – Subsystem RFANalyzer..... | 6.43 |
| Subsystem RFANalyzer:CONTRol | 6.44 |
| Results – Subsystem RFANalyzer:POWER? | 6.45 |
| Subsystem RFGenerator | 6.45 |
| Subsystem RFGenerator[:TX] (TX Generator Control)..... | 6.46 |
| Subsystem RFGenerator[:TX]... (TX Generator Settings) | 6.46 |
| Subsystem RFGenerator:MODulation (Frequency Modulation) | 6.47 |
| Subsystem RFGenerator:FHOPping (Frequency Hopping)..... | 6.49 |
| Subsystem RFGenerator:PULSe (Ramping) | 6.50 |

| | |
|--|--------------|
| Subsystem RFGenerator:LSMode (Low Spur Mode) | 6.50 |
| Subsystem RFGenerator:BANDwidth (Bandwidth) | 6.50 |
| Subsystem RFGenerator:AUXTx... (Aux TX Signal)..... | 6.51 |
| Subsystem RFGenerator:GLISTmode... (Generator List Mode)..... | 6.53 |
| Subsystems INPut, OUTPut, CORRection:LOSS..... | 6.57 |
| Subsystem DM:CLOCK (Synchronization)..... | 6.59 |
| I/Q-IF Interface | 6.59 |
| Power Measurements (POWer)..... | 6.62 |
| Measurement Control – Subsystem POWer..... | 6.62 |
| Test Configuration..... | 6.63 |
| Subsystem POWer:CONTRol (Control)..... | 6.63 |
| Subsystem POWer:FREQuency (Frequency/RBW) | 6.64 |
| Subsystem POWer:LEVel (Level)..... | 6.64 |
| Subsystem POWer:TIME | 6.65 |
| Subsystem SUBarrays:POWer | 6.66 |
| Results – Subsystem POWer...? | 6.67 |
| Spectrum Measurements (SPECTrum) | 6.69 |
| Measurement Control – Subsystem SPECTrum..... | 6.69 |
| Test Configuration..... | 6.70 |
| Subsystem SPECTrum:CONTRol | 6.70 |
| Subsystem SPECTrum:FREQuency (Frequency/RBW) | 6.71 |
| Subsystem SPECTrum:LEVel (Level)..... | 6.72 |
| Subsystem SUBarrays:SPECTrum | 6.73 |
| SPECTrum Markers..... | 6.74 |
| Results – Subsystem SPECTrum | 6.75 |
| WPOWer..... | 6.77 |
| Measured Values – Subsystem WPOWer?..... | 6.78 |
| NPOWer (Function Group RF)..... | 6.79 |
| Subsystem NPOWer:CONTRol | 6.80 |
| Subsystem NPOWer:FREQuency (RBW) | 6.81 |
| Measured Values – Subsystem NPOWer?..... | 6.82 |
| I/Q Recorder | 6.82 |
| Measurement Control | 6.83 |
| Test Configuration..... | 6.84 |
| Subarray Configuration | 6.87 |
| ASCII Results – Subsystem IQRecorder:ARRAy..... | 6.88 |
| Measured Subarrays – Subsystem IQRecorder:SUBArray..... | 6.91 |
| Binary Results – Subsystem IQRecorder:BINARy:ARRAy | 6.94 |
| I/Q vs. Slot (IQSLot) | 6.99 |
| Measurement Control | 6.99 |
| Test Configuration..... | 6.100 |
| Display Configuration | 6.103 |
| Subarray Definition..... | 6.104 |
| Retrieving Results | 6.104 |
| Audio Generator and Analyzer (Option R&S CMU-B41) | 6.107 |
| Subsystem AFLevel (AF Input Level)..... | 6.108 |
| Audio Analyzer (AFANalyzer) | 6.109 |
| Subsystem AFANalyzer (Measurement Control)..... | 6.109 |
| Subsystem AFANalyzer...:CONTRol (Control)..... | 6.111 |

| | |
|--|--------------|
| Subsystem AFANalyzer...:FILTer (Filter) | 6.112 |
| Subsystem AFANalyzer... (Measured Values)..... | 6.115 |
| AF Generator (AFGenerator) | 6.115 |
| Multitone Measurement (MULTitone)..... | 6.117 |
| Single-Tone Measurement (MULTitone:AF<n>Channel) | 6.117 |
| Measurement Control – Subsystem MULTitone | 6.117 |
| Test Configuration..... | 6.119 |
| Results – Subsystem MULTitone:...? | 6.127 |
| MULTitone:STEReo Subsystem | 6.129 |
| Measurement Control – Subsystem MULTitone | 6.129 |
| Test Configuration..... | 6.130 |
| Results – Subsystem MULTitone:...? | 6.138 |
| Total Harmonic Noise Measurement (THD)..... | 6.140 |
| Single-Tone THD (THD:AF<n>Channel) | 6.141 |
| Measurement Control..... | 6.141 |
| Test Configuration..... | 6.142 |
| Results – Subsystem THD:...? | 6.145 |
| THD:STEReo Subsystem | 6.146 |
| Measurement Control..... | 6.146 |
| Test Configuration..... | 6.147 |
| Results – Subsystem THD:...? | 6.148 |
| List of Commands | 6.151 |
| Alphabetical Command Lists..... | 6.171 |

6 Remote Control – Commands

In the following, all remote-control commands for the *Base* system and the function groups *RF* and *Audio* will be presented in tabular form with their parameters and the ranges of numerical values. The chapter is organized as follows:

- Common commands, commands for the *Base* system and the function groups *RF* and *Audio* are presented separately.
- Within the measurement modes, first the general configuration and then the individual measurement groups are described.

Unless otherwise stated in the command description, all commands may be used for control of the R&S® CMU via GPIB interface or serial (RS-232) interface. An introduction to remote control according to the SCPI standard, the status registers of the R&S® CMU, and the operating concept and measurement control is given in Chapter 5.

Special Terms and Notation

This section describes some particular features in the syntax of the remote control commands. The general description of the SCPI command syntax can be found in section *Structure and Syntax of Device Messages* in Chapter 5.

Description of commands

The commands are arranged in tables; all of them are arranged in the same way. From top to bottom, the table rows contain the following entries:

1. Complete command syntax including the parameter list and a short description of the command,
2. List and description of the parameters with their default values, the units, and unit rings.
3. Detailed description of the command, signalling state required for command execution, required firmware version.

Extensive lists of default values are annexed to the command description.

Order of commands

The commands are arranged according to their function. The general purpose of a command is described by the keyword in the second level. Lower-level keywords define the command in more detail. This means that commands with the same second-level, third-level etc. keywords are generally grouped together in the same sections.

Example: `CONFigure:POWer:FREQuency:CENTer <Frequency>`

Commands with the keyword *POWER* in the second level belong to the power measurement. The keywords in the third and fourth levels indicate that the command defines the center analyzer frequency used in the power measurement.

Measurement object The term *measurement object* denotes a group of remote control commands relating to the same group of measured quantities. E.g., all commands concerning the measurement of the signal power vs time form a common measurement object.

Combined measurements To limit the number of remote control command and their parameters, scalar quantities of the same measurement object are always measured together and returned in lists.

Parameters Many commands are supplemented by a parameter or a list of parameters. Parameters either provide alternative options (setting a or setting b or setting c ..., see special character "|"), or they form a list separated by commas (setting x,y).

<Par_Name> In the command tables and lists, parameters are generally described by a name (literal) written in angle brackets (<>). This literal merely serves as a parameters description; in an application program it must be replaced by one of the possible settings reported in the detailed parameter description.

Example: `CONFigure:POWer:CONTrol <Mode>,<Statistics>`
 with `<Mode> = SCALar | ARRay`
`<Statistics> = 1 to 10000 | NONE`
 possible command syntax: `CONF:POW:CONT SCAL,OFF`

NAN NAN (not a number) is generally used to represent missing data, e.g. if a portion of a trace has not been acquired yet. It is also returned after invalid mathematical operations such as division by zero. As defined in the SCPI standard, NAN is represented as 9.91 E 37.

INV INV (invalid) is returned if a limit check is performed without defining the appropriate tolerance values.

Upper / lower case

Upper/lower case characters characterize the long and short form of the keywords in a command. The short form consists of all upper-case characters, the long form of all upper case plus all lower case characters. On the R&S® CMU, either the short form or the long form are allowed; mixed forms will generally not be recognized. Either the short form or the long form are permissible. The instrument itself does not distinguish upper case and lower case characters.

Special characters

| A vertical stroke in the parameter list characterizes alternative parameter settings. Only one of the parameters separated by | must be selected.

Example: The following command has two alternative settings:

`TRIGger:SEQuence:DEFault ON | OFF`

[] *Key words* in square brackets can be omitted when composing the command header (see Chapter 5, section "Structure of a Command"). The complete command must be recognized by the instrument for reasons of compatibility with the SCPI standard.

Parameters in square brackets are optional as well. They may be entered in the command or omitted.

{ } Braces or curly brackets enclose one or more parameters that may be included zero or more times.

<nr> This symbol stands for a numeric suffix, e.g. an enumeration index for input and output connectors.

Lists of commands

Command: The *Command* column of the table contains all remote control commands arranged according to their function (configurations or measurement objects). Within a section, the commands are listed in alphabetical order.

Parameters: The *Parameter* column lists the parameters of the commands.

Remarks: The *Remarks* column gives additional information about the commands which

- Have no query form (*no query*)
- Have only a query form (*query only*)
- Can be used both as setting commands and as queries (*with query*, this applies to all commands belonging to none of the two preceding categories)

Alphabetical Lists Chapter 6 concludes with alphabetical command lists for both test modes.

Common Commands

The common commands are taken from the IEEE 488.2 (IEC 625-2) standard. These commands have the same effect on different devices. The headers of these commands consist of "*" followed by three letters. Many common commands are related to the status reporting system which is described in detail in Chapter 5.

Table 6-1 Common Commands

| Command | Parameters | Remark |
|---------|--------------|--|
| *CLS | | no query |
| *ESE | 0 to 255 | |
| *ESR? | | query only |
| *GTL | | not IEEE 488.2 confirmed; see p. 6.25 and Chapter 8, <i>Addressed Commands</i> |
| *IDN? | | query only |
| *IST? | | query only |
| *LLO | TRUE FALSE | not IEEE 488.2 confirmed; see p. 6.27 and Chapter 8, <i>Universal Commands</i> |
| *OPC | | |
| *OPT? | | query only |
| *PRE | 0 to 255 | |
| *PSC | 0 1 | |
| *RST | | no query |
| *SEC | 0 to 30 | not IEEE 488.2 confirmed; see p. 6.14 |
| *SRE | 0 to 255 | |
| *STB? | | query only |
| *TST? | | query only |
| *WAI | | |

*CLS

CLEAR STATUS sets the status byte (STB), the standard event register (ESR) and the EVENT-part of the QUESTIONable and the OPERATION register to zero. The command does not alter the mask and transition parts of the registers. It clears the output buffer.

*ESE 0 to 255

EVENT STATUS ENABLE sets the event status enable register to the value indicated. The query *ESE? returns the contents of the event status enable register in decimal form.

*ESR?

STANDARD EVENT STATUS QUERY returns the contents of the event status register in decimal form (0 to 255) and subsequently sets the register to zero.

***IDN?**

IDENTIFICATION QUERY queries the instrument identification.

***IST?**

INDIVIDUAL STATUS QUERY returns the contents of the IST flag in decimal form (0 | 1). The IST-flag is the status bit which is sent during a parallel poll (see chapter 5).

***OPC**

OPERATION COMPLETE sets bit 0 in the event status register when all preceding commands have been executed. This bit can be used to initiate a service request (see chapter 5).

***OPC?**

OPERATION COMPLETE QUERY writes message "1" into the output buffer as soon as all preceding commands have been executed (cf. chapter 5).

***OPT?**

OPTION IDENTIFICATION QUERY queries the options included in the instrument and returns a list of the options installed. The response consists of Arbitrary ASCII response data according to IEEE 488.2. The options are returned at fixed positions in a comma-separated string. A zero is returned for options that are not installed.

Example:

```
0,0,0,0,B11,0,B21Var02,0,0,0,B41,B52Var02,0,0,0,0,0,0,0,0,0,0,0,0,0,0,0,0,0,0,0,0,0,0,0,0,0,0,PCMCIA,0,0,0,0,0,0,0,0,K20,K21,K22,K23,K24,K27,K28,K29,0,0,0,0,0,0,0,0,K42,K43,0,0,0,0,0,0,0,0,0,0,K83,K84,K85,K86,0,FMR5,AMD K6-2,64 MB,0,0,0,0,rxtx1,0,0,0,0,0
```

An alternative list of options can be queried via the command `SYSTEM:OPTions?` See also description of *Setup – Options* menu in Chapter 4.

The CMU hardware options are listed at the beginning of the output string, e.g.:

| Response | Description | Response | Description |
|----------------|------------------------------|----------------|-------------------------------|
| B1/B2 | OCXO | B54Var02/Var14 | Sig. Mod. for GSM, TDMA, AMPS |
| B5 | GSM Linkhandler (CRTU) | B56Var14 | Power PC for USU |
| B6 | MAC/Speech Board (CRTU) | B56Var02/Var14 | Power PC |
| B7 | I/Q-IF Interface (CRTU) | B66 | WCDMA L1 Copro |
| B9 | Two auxiliary RF generators | B68 | WCDMA L1 Copro, fully fitted |
| B11/B12 | OCXO | B71 | ABIS (CMU300) |
| B17 | I/Q-IF Interface | B73 | A/B Board |
| B21 | Universal Signalling Unit | B76 | WCDMA L1 Copro (CMU300) |
| B21Var14 | USU for WCDMA, GPRS | B81 | cdmaOne LH |
| B21Var02 | ULH for GSM, TDMA, AMPS | B82 | Access Board for B81/83 |
| B21Var02/Var14 | Universal Signalling Unit | B83 | CDMA2000 LH |
| B41 | Audio option | B85 | Speech codec for B83 |
| B52 | Speech coder for CMU-B21 | B88 | HDR option for B83 |
| B52Var14 | Speech coder for USU | B91 | Second RF Channel |
| B52Var02 | Speech coder for ULH | B95 | Additional RF Generator |
| B52Var02/Var14 | Speech coder | U61 | Floppy disk |
| B53 | Bluetooth | B62 | – |
| B53Var14 | Bluetooth for USU | U65 | DDC400 for WCDMA |
| B53Var02 | Bluetooth for ULH | U75 | DDC400 for WCDMA Var04 |
| B53Var02/Var14 | Bluetooth | U99 | RF1 with RF2 Level Range |
| B54Var14 | Sig. Mod. f. GSM, TDMA, AMPS | 0 | not used |

The CMU software options are listed after the software options, e.g.:

| Response | Description | Response | Description |
|----------|--------------------------|----------|-----------------------------|
| K0 | DemoPack | K43 | EGPRS Signalling |
| K2 | GSM Activation (CRTU) | K45 | AMR GSM for CMU200 |
| K5 | CRTU-G Activation (CRTU) | K53 | Bluetooth |
| K6 | WCDMA Activation (CRTU) | K65 | WCDMA UE TX Test (3GPP/FDD) |
| K20 | GSM400-MS | K66 | WCDMA DL Generator |
| K21 | GSM900-MS | K67 | WCDMA Signalling Band III |
| K22 | GSM1800-MS | K68 | WCDMA Signalling Band I |
| K23 | GSM1900-MS | K69 | WCDMA Signalling Band II |
| K24 | GSM850-MS | K75 | WCDMA Node B Test (CMU300) |
| K27 | IS 136-800-MS | K76 | WCDMA UL Generator (CMU300) |
| K28 | IS 136-1900-MS | K81 | CDMA1-MS 800 |
| K29 | AMPS-MS | K82 | CDMA1-MS 1700/1900 |
| K30 | GSM400-BS | K83 | CDMA2000 450 |
| K31 | GSM900-BS | K84 | CDMA2000 800 |
| K32 | GSM1800-BS | K85 | CDMA2000 1700/1900 |
| K33 | GSM1900-BS | K86 | CDMA2000 2200 |
| K34 | GSM850-BS | K88 | 1xEV-DO |
| K39 | MOC/MTC for GSM-BS | | |
| K41 | EDGE | | |
| K42 | GPRS Signalling | | |

The CMU hardware equipment is listed after the hardware options, e.g.:

| Response | Description | Response | Description |
|------------|-------------------------|----------|-------------|
| FMR5/6 | Front Module Controller | 0 | not used |
| <CPU_Type> | – | 0 | not used |
| <Memory> | – | 0 | not used |

The CMU firmware versions are listed after the hardware equipment, e.g.:

| Response | Description | Response | Description |
|----------|-------------|----------|-------------|
| uP1 | – | 0 | not used |
| uP2 | – | 0 | not used |
| 0 | not used | 0 | not used |

*PRE 0 to 255

PARALLEL POLL REGISTER ENABLE sets parallel poll enable register to the value indicated. Query *PRE? returns the contents of the parallel poll enable register in decimal form.

*PSC 0 | 1

POWER ON STATUS CLEAR determines whether the contents of the ENABLE registers is maintained or reset when the instrument is switched on.

*PSC = 0 causes the contents of the status registers to be maintained. Thus a service request can be triggered on switching on in the case of a corresponding configuration of status registers ESE and SRE.

*PSC ≠ 0 ≠resets the registers.

Query *PSC? reads out the contents of the power-on-status-clear flag. The response can be 0 or 1.

***RST**

RESET sets the instrument to a defined default status. The command resets all function groups and test modes, restoring the default values defined for remote control operation. *RST is equivalent to `SYSTem:RESet[:ALL]`. The default settings are indicated in the description of commands.

***SRE 0 to 255**

SERVICE REQUEST ENABLE sets the service request enable register to the value indicated. Bit 6 (MSS mask bit) remains 0. This command determines under which conditions a service request is triggered. The query *SRE? returns the contents of the service request enable register in decimal form. Bit 6 is always 0.

***STB?**

READ STATUS BYTE QUERY reads the contents of the status byte in decimal form.

***TST?**

SELF TEST QUERY triggers selftests of the instrument and outputs an error code in decimal form (the output is zero in the current firmware version).

***WAI**

WAIT-to-CONTINUE prevents servicing of the subsequent commands until all preceding commands have been executed and all signals have settled (see also chapter 5 and *OPC).

Base System Commands

The commands in the R&S® CMU base system are used to query the instrument state, perform general device configurations, set and query the status registers, reset the instrument, manage files and configure the reference frequency.

System Commands

The SYSTEM subsystem contains the functions that are not related to instrument performance. The R&S® CMU supports the following SCPI-confirmed SYSTEM commands:

| SYSTEM:ERROR? | | | | Error Queue |
|---|-----------------------|---------------|--------------|-------------|
| Response | Parameter description | Def. value | Default unit | FW vers. |
| -32768 to +32768 and error string Ex.: -230,"Data corrupt or stale" | Error message | 0, "No error" | – | V1.20 |
| Command description | | | | |
| This command queries the next entry from the error/event queue and deletes it. Positive error numbers are instrument-dependent; negative error numbers are reserved by the SCPI standard, see chapter 9. If the error queue is empty, the error number 0, "No error" is returned. | | | | |

| SYSTEM:VERSion? | | | | SCPI Version |
|--|--------------------------|------------|--------------|--------------|
| Response | Parameter description | Def. value | Default unit | FW vers. |
| YYYY.V Ex.: 1999.0 | SCPI version of R&S® CMU | – | – | V1.20 |
| Command description | | | | |
| This command queries the SCPI version number to which the instrument complies. YYYY is the year of SCPI compliance, V is the version number within the year. | | | | |

| SYSTEM:NONVolatile:DISable | | Disable Non Volatile RAM |
|--|--|--------------------------|
| Command description | | FW vers. |
| This command has no query form. It prevents the R&S® CMU from saving measurement settings to the non volatile ram. This improves the system performance but implies that the current settings will not be saved for later sessions. Disabling the non volatile ram is recommended for instruments equipped with an FMR 6 Front Module controller that are operated in remote control mode. | | V3.00 |
| Note: <i>There is no way to cancel the effect of the SYSTEM:NONVolatile:DISable command within the current session, even if the R&S® CMU is switched to manual control (Local). To re-enable the non volatile ram, the R&S® CMU must be rebooted.</i> | | |

| SYSTEM:REBoot | | System Reboot |
|--------------------------------------|--|---------------|
| Description of command | | FW vers. |
| This command reboots the instrument. | | V4.30 |

| SYSTem:REBoot:ERROr <Enable> | | | Reboot on Error | |
|--|--|------------|-----------------|----------|
| <Enable> | Parameter description | Def. value | Default unit | FW vers. |
| ON OFF | System error causes an automatic reboot System error requires manual reboot | OFF | – | V5.00 |
| Command description | | | | |
| <p>This command has no query form. If it is sent with the parameter ON, any subsequent non-recoverable system error will cause a shutdown and automatic reboot of the R&S® CMU. The R&S CMU will be able to continue a running remote control script, provided that the controller program allows the instrument to pause for some time.</p> <p>After the reboot, or after a reset of the instrument (*RST, SYSTem:RESet..., SYSTem:PRESet[:ALL]), Reboot on Error is disabled so that successive system errors will be displayed in red message boxes.</p> <p>SYSTem:REBoot:ERROr ON is effective in remote control mode only.</p> | | | | |

| SYSTem:OPTions:MEquipment? | | | Measurement Equipment | |
|--|---|---------------|-----------------------|----------|
| Response | Parameter description | Def. value | Default unit | FW vers. |
| <Stock_No>, <Mod_index> NAN, NAN, ... | Part no. and modification index of hardware equipment Hardware equipment not available | NAN, NAN, ... | – | V3.50 |
| Command description | | | | |
| <p>This command queries the hardware equipment of the CMU. Each board or hardware option is listed with its stock number and modification index. The equipment is returned in the following order:</p> <p>Reference Board RF1RF2 Frontend RXTX Board (several items for board and modules) Additional RF Generator Digital Board (several items for board and modules) OCXO Reference Oscillator IQ/IF Interface Audio Board (several items for board and modules) Universal Signalling Unit (several items for board and modules)</p> | | | | |

Status Commands

The STATus subsystem controls the SCPI-defined status reporting structures. The purpose and definition of status registers is given in Chapter 5, section "Status Reporting System". Unless otherwise stated, all the following commands are SCPI-confirmed.

| STATus:OPERation[:EVENT]? | | | Event Part | |
|---|-----------------------|-------------------------|--------------|----------|
| Response | Parameter description | Def. value ¹ | Default unit | FW vers. |
| 0 to 32767 | Event part | – | – | V1.20 |
| Command description | | | | |
| This command queries and deletes the contents of the EVENT part of the STATus:OPERation register. | | | | |

¹ *RST does not supersede the entries in the status registers; for an overview of the reset values of the STATus... system refer to section *Reset Values of the Status Reporting Systems* in chapter 5.

| STATus:OPERation:ENABLE <Number> | | | | Enable part |
|---|-----------------------|------------|--------------|-------------|
| <Number> | Parameter description | Def. value | Default unit | FW vers. |
| 0 to 32767 | Enable part | – | – | V1.20 |
| Command description | | | | |
| This command enters a number to be interpreted as a bit pattern in the ENABLE part of the STATus:OPERation register. If a bit is set the corresponding event is reported in the summary bit of the status byte. | | | | |

| STATus:OPERation:CMU:SUM<nr>[:EVENT]? | | | | Event part |
|--|-----------------------|------------|--------------|------------|
| Response | Parameter description | Def. value | Default unit | FW vers. |
| 0 to 32767 | Event part | – | – | V1.20 |
| Command description | | | | |
| This command queries and deletes the contents of the EVENT part of the STATus:OPERation:CMU:SUM<nr> register (<nr> = 1,2). | | | | |

| STATus:OPERation:CMU:SUM<nr>:ENABLE <Number> | | | | Enable part |
|--|-----------------------|------------|--------------|-------------|
| <Number> | Parameter description | Def. value | Default unit | FW vers. |
| 0 to 32767 | Enable part | – | – | V1.20 |
| Command description | | | | |
| This command enters a number to be interpreted as a bit pattern in the ENABLE part of the STATus:OPERation:CMU:SUM<nr> register (<nr> = 1,2). If a bit is set the corresponding event is reported in the summary bit of the status byte. | | | | |

| STATus:OPERation:CMU:SUM<nr>:CMU<nr_event>[:EVENT]? | | | | Event part |
|---|-----------------------|------------|--------------|------------|
| Response | Parameter description | Def. value | Default unit | FW vers. |
| 0 to 32767 | Event part | – | – | V1.20 |
| Command description | | | | |
| This command queries and deletes the contents of the EVENT part of the STATus:OPERation:CMU:SUM<nr>:CMU<nr_event> register (<nr> = 1 to 2; <nr_event> = 1 to 15). | | | | |

| STATus:OPERation:CMU:SUM<nr>:CMU<nr_event>:ENABLE <Number> | | | | Enable part |
|---|-----------------------|------------|--------------|-------------|
| <Number> | Parameter description | Def. value | Default unit | FW vers. |
| 0 to 32767 | Enable part | – | – | V1.20 |
| Command description | | | | |
| This command enters a number to be interpreted as a bit pattern in the ENABLE part of the STATus:OPERation:CMU:SUM<nr>:CMU<nr_event> register (<nr> = 1 to 2; <nr_event> = 1 to 15). If a bit is set the corresponding event is reported in the summary bit of the status byte. | | | | |

| STATus:OPERation:CMU:ALL? | | Query all operation registers | | |
|--|---|-------------------------------|--------------|----------|
| <i>Response</i> | Parameter description | Def. value | Default unit | FW vers. |
| 0 to 32767, ... , 0 to 32767 | Event part of all CMU operation registers | – | – | V1.20 |
| Command description | | | | |
| This command queries the EVENT parts of all STATus:OPERation:CMU:SUM<nr>:CMU<nr_event> registers. The result is returned as a list of 30 integer values separated by commas. | | | | |

| STATus:OPERation:CMU:CLEAr | | Clear all operation registers | | |
|--|--|-------------------------------|--|----------|
| Command description | | | | FW vers. |
| This command clears the EVENT parts of all STATus:OPERation:CMU:SUM<nr>:CMU<nr_event> registers (<nr> = 1 to 2; <nr_event> = 1 to 15). | | | | V1.20 |

| STATus:QUEStionable[:EVENT]? | | Event part | | |
|--|-----------------------|------------|--------------|----------|
| <i>Response</i> | Parameter description | Def. value | Default unit | FW vers. |
| 0 to 32767 | Event part | – | – | V1.20 |
| Command description | | | | |
| This command queries and deletes the contents of the EVENT part of the STATus:QUEStionable register. | | | | |

| STATus:QUEStionable:ENABle <Number> | | Enable part | | |
|--|-----------------------|-------------|--------------|----------|
| <Number> | Parameter description | Def. value | Default unit | FW vers. |
| 0 to 32767 | Enable part | – | – | V1.20 |
| Command description | | | | |
| This command enters a number to be interpreted as a bit pattern in the ENABLE part of the STATus:QUEStionable register. If a bit is set the corresponding event is reported in the summary bit of the status byte. | | | | |

| STATus:PRESet | | Reset status registers | | |
|---|--|------------------------|--|----------|
| Command description | | | | FW vers. |
| This command sets the transition filters (PTRansition and NTRansition filters) and the ENABLE registers of the STATus:OPERation and the STATus:QUEStionable registers to defined values: | | | | V1.20 |
| <ul style="list-style-type: none"> • PTRansition is set to 32767 (0x7FFF), i.e. all hardware events are detected and transferred to the EVENT register. • NTRansition is set to 0, i.e. a hardware event that disappears does not cause any change in the EVENT register. | | | | |
| The ENABLE registers are also set to 0 so that events are not reported in the status byte. | | | | |

Symbolic Status Event Register Evaluation

The following commands are used to retrieve the events reported and the corresponding function groups; see section *Symbolic Status Event Register Evaluation* in Chapter 5.

| STATus:OPERation:EVENT:SADdress? | | Check event reporting | | |
|--|---|-------------------------|--------------|----------|
| Response | Parameter description | Def. Value ² | Default Unit | FW vers. |
| 1 to 30, "Fgrp" | "Next" secondary address Corresponding function group name (or "", if no event was reported) | 31 "" | – – | V2.10 |
| Command description | | | | |
| <p>This command is always a query. It checks the <code>STATus:OPERation:CMU:SUM<nr>:EVENTt</code> sum registers (<nr> = 1 2), returns the next secondary address and function group string where an event was reported, and deletes the entry in the <code>EVENTt</code> register. If applied repeatedly, the command checks the secondary addresses in ascending order (i.e. the events are not queried chronologically).</p> <p>The command is global; it is available in all function groups. Possible responses are:</p> <p>1, "RF_NSig" An event was reported in function group <i>RF</i> (currently assigned to secondary address 1).</p> <p>31, "" No (further) event reported.</p> | | | | |

| STATus:OPERation:SYMBOLic:ENABLE <Event>{,<Event>} | | Symbolic status evaluation | | |
|--|--|----------------------------|--------------|----------|
| Parameter list | Parameter description | Def. Value ³ | Default Unit | FW vers. |
| <Event>{,<Event>} NONE | List of symbols for events to be reported No event reported | NONE | – | V2.10 |
| Command description | | | | |
| <p>This command enables event reporting for one or several events in the current function group, i.e. it sets the corresponding bits in the <code>STATus:OPERation:CMU:SUM<nr>:CMU<nr_event>:ENABLE</code> register (<nr> = 1 2, <nr_event> denotes the current function group) and in all sum registers up to the status byte. The events and the corresponding symbols for each function group are listed in chapter 5 of the relevant manuals (see section <i>Status Registers</i>). The symbols may be entered in arbitrary order.</p> | | | | |

| STATus:OPERation:SYMBOLic[:EVENT]? | | Symbolic status evaluation | | |
|---|---|----------------------------|--------------|----------|
| Response | Parameter description | Def. Value ⁴ | Default Unit | FW vers. |
| NONE <Event>{,<Event>} | No event in the current function group List of reported events | NONE | – | V2.10 |
| Command description | | | | |
| <p>This command is always a query. It lists the events reported in the current function group and deletes these events in the <code>STATus:OPERation:CMU:SUM<nr>:CMU<nr_event>:EVENT</code> register as well as in all sum registers.</p> | | | | |

² The default values quoted in this command are achieved after a *CLS command. *RST does not supersede the entries in the status registers; see section *Reset Values of the Status Reporting Systems* in chapter 5.

³ The default values quoted in this command are achieved after a STATus:PRESet command. *RST does not supersede the entries in the status registers; see section *Reset Values of the Status Reporting Systems* in chapter 5.

⁴ The default values quoted in this command are achieved after a *CLS command. *RST does not supersede the entries in the status registers; see section *Reset Values of the Status Reporting Systems* in chapter 5.

Setup – Basic Device Settings

The SETup subsystem contains the commands for global configuration of the remote control parameters, the serial interfaces, the options, date and time, the keyboard and beeper. It corresponds to the *Setup* menu opened via the *SETUP* key on the front panel.

Subsystem Remote

The *REMOte* subsystem contains the commands for configuration of the remote control parameters. It corresponds to the *Remote* tab in the *Setup* menu opened via the *SETUP* key on the front panel.

| SYSTem:REMOte:ADDRes:PRIMary <Addr> | | | | Primary Address |
|--|--|------------|--------------|-----------------|
| <Addr> | Parameter description | Def. value | Default unit | FW vers. |
| 0 to 30 | Primary address to the GPIB (IEEE) bus | 20 | – | V1.20 |
| Command description | | | | |
| This command sets the primary address of the GPIB driver which is used to address the device (R&S® CMU). It is equivalent to <code>SYSTem:COMMunicate:GPIB[:SELF]:ADDRes</code> (see below). | | | | |

| SYSTem:REMOte:ADDRess:SECOndary <Addr>,<FGrp> | | Secondary Address | | | | | | | | | | | | | | | | | | | | | | | | | | | | | | | | | | | | | | |
|---|---|-----------------------------|-------------------------------|----------|-----------|----------------|-----------|----------------|------|----------------------|----------------|--------------------------|---------|-------------------|---------------|----------------------|---------------|--------------------------|--|-------------------------------|--------------|----------------------|-----------------|---------------------------|----------------|---------------------------|--|------------------------------|---------------|-----------------------|------------------|----------------------------|----------------|---------------------------|--|-----------------------------|-------------|------------------------|------------|--------------------|
| <Addr>,<FGrp> | Parameter description | Def. value | Default unit | FW vers. | | | | | | | | | | | | | | | | | | | | | | | | | | | | | | | | | | | | |
| 1 to 29, „FGrp_name“ NONE | Secondary address of the function group Name of the function group or NONE if the secondary address is not to be mapped | Configura- tion-specific | – | V1.17 | | | | | | | | | | | | | | | | | | | | | | | | | | | | | | | | | | | | |
| Command description | | | | | | | | | | | | | | | | | | | | | | | | | | | | | | | | | | | | | | | | |
| <p>This command assigns the secondary addresses to the remote control modes (function groups) of the GPIB driver (compare next command). If a secondary address is successively assigned to different function groups, the previous assignments are overwritten. The function group names are quoted at the beginning of Chapter 5 of each network test manual; some examples are:</p> <table border="1"> <thead> <tr> <th>FGrp_name</th> <th>Function Group</th> <th>FGrp_name</th> <th>Function Group</th> </tr> </thead> <tbody> <tr> <td>BASE</td> <td>R&S® CMU base system</td> <td>Bluetooth_NSig</td> <td>Bluetooth Non Signalling</td> </tr> <tr> <td>RF_NSig</td> <td>RF Non Signalling</td> <td>Bluetooth_Sig</td> <td>Bluetooth Signalling</td> </tr> <tr> <td>GSM900MS_NSig</td> <td>GSM900-MS Non Signalling</td> <td></td> <td>AUDIO_NSigAudio Generator and</td> </tr> <tr> <td>GSM900MS_Sig</td> <td>GSM900-MS Signalling</td> <td>IS136800MS_NSig</td> <td>TDMA800-MS Non Signalling</td> </tr> <tr> <td>GSM1800MS_NSig</td> <td>GSM1800-MS Non Signalling</td> <td></td> <td>IS136800MS_SigTDMA800-MS Sig</td> </tr> <tr> <td>GSM1800MS_Sig</td> <td>GSM1800-MS Signalling</td> <td>IS1361900MS_NSig</td> <td>TDMA1900-MS Non Signalling</td> </tr> <tr> <td>GSM1900MS_NSig</td> <td>GSM1900-MS Non Signalling</td> <td></td> <td>IS1361900MS_NSigTDMA1900-MS</td> </tr> <tr> <td>AMPSMS_NSig</td> <td>AMPS-MS Non Signalling</td> <td>AMPSMS_Sig</td> <td>AMPS-MS Signalling</td> </tr> </tbody> </table> <p>The R&S® CMU base system (function group <i>BASE</i>) is always assigned to secondary address 0; the assignment cannot be changed by the <code>SYSTem:REMOte:ADDRess:SECOndary</code> command. A program example illustrating how to adapt the secondary addresses to the requirements of a specific driver can be found in chapter 7.</p> <p>Example: Setting: <code>SYST:REM:ADDR:SEC 2,"Bluetooth_NSig"</code> <code>SYST:REM:ADDR:SEC 1,NONE</code></p> <p>Query: <code>SYST:REM:ADDR:SEC? 2</code> --> Response: "Bluetooth_NSig"</p> <p>Query: <code>SYST:REM:ADDR:SEC? 1</code> --> Response: NONE</p> <p>Query: <code>SYST:REM:ADDR:SEC?</code> --> Response: NONE,"Bluetooth_NSig", ... (30 returned values)</p> | | | | | FGrp_name | Function Group | FGrp_name | Function Group | BASE | R&S® CMU base system | Bluetooth_NSig | Bluetooth Non Signalling | RF_NSig | RF Non Signalling | Bluetooth_Sig | Bluetooth Signalling | GSM900MS_NSig | GSM900-MS Non Signalling | | AUDIO_NSigAudio Generator and | GSM900MS_Sig | GSM900-MS Signalling | IS136800MS_NSig | TDMA800-MS Non Signalling | GSM1800MS_NSig | GSM1800-MS Non Signalling | | IS136800MS_SigTDMA800-MS Sig | GSM1800MS_Sig | GSM1800-MS Signalling | IS1361900MS_NSig | TDMA1900-MS Non Signalling | GSM1900MS_NSig | GSM1900-MS Non Signalling | | IS1361900MS_NSigTDMA1900-MS | AMPSMS_NSig | AMPS-MS Non Signalling | AMPSMS_Sig | AMPS-MS Signalling |
| FGrp_name | Function Group | FGrp_name | Function Group | | | | | | | | | | | | | | | | | | | | | | | | | | | | | | | | | | | | | |
| BASE | R&S® CMU base system | Bluetooth_NSig | Bluetooth Non Signalling | | | | | | | | | | | | | | | | | | | | | | | | | | | | | | | | | | | | | |
| RF_NSig | RF Non Signalling | Bluetooth_Sig | Bluetooth Signalling | | | | | | | | | | | | | | | | | | | | | | | | | | | | | | | | | | | | | |
| GSM900MS_NSig | GSM900-MS Non Signalling | | AUDIO_NSigAudio Generator and | | | | | | | | | | | | | | | | | | | | | | | | | | | | | | | | | | | | | |
| GSM900MS_Sig | GSM900-MS Signalling | IS136800MS_NSig | TDMA800-MS Non Signalling | | | | | | | | | | | | | | | | | | | | | | | | | | | | | | | | | | | | | |
| GSM1800MS_NSig | GSM1800-MS Non Signalling | | IS136800MS_SigTDMA800-MS Sig | | | | | | | | | | | | | | | | | | | | | | | | | | | | | | | | | | | | | |
| GSM1800MS_Sig | GSM1800-MS Signalling | IS1361900MS_NSig | TDMA1900-MS Non Signalling | | | | | | | | | | | | | | | | | | | | | | | | | | | | | | | | | | | | | |
| GSM1900MS_NSig | GSM1900-MS Non Signalling | | IS1361900MS_NSigTDMA1900-MS | | | | | | | | | | | | | | | | | | | | | | | | | | | | | | | | | | | | | |
| AMPSMS_NSig | AMPS-MS Non Signalling | AMPSMS_Sig | AMPS-MS Signalling | | | | | | | | | | | | | | | | | | | | | | | | | | | | | | | | | | | | | |

| *SEC <Addr> | | Secondary Address | | |
|--|-----------------------|-------------------|--------------|----------|
| <Addr> | Parameter description | Def. value | Default unit | FW vers. |
| 0 to 29 | Secondary address | 0 | – | V1.20 |
| Command description | | | | |
| <p>This command has no query form. It switches over to the specified secondary address. It is required if the serial interface is used for remote control (software switchover, RS-232 remote interface, see previous command and section <i>Setting the Device Address</i> in chapter 5).</p> | | | | |

| SYSTem:REMOte:ADDRess:SECOndary:UNMap | | Unmap all Secondary Addresses | | |
|---|--|-------------------------------|--|--|
| Command description | | | | |
| <p>This command has no query form. It clears the mapping between all secondary addresses and function groups (see <code>SYSTem:REMOte:ADDRess:SECOndary</code> or <code>*SEC</code>). The R&S® CMU base system (function group <i>BASE</i>) is always mapped to secondary address 0; this assignment cannot be cleared.</p> <p>The command is available in versions V3.50 and higher of the R&S® CMU base system.</p> | | | | |

| SYSTem:REMOte:TPManagement <Enable> | | Task Priority Management | | |
|---|--|--------------------------|--------------|----------|
| <Enable> | Parameter description | Def. value | Default unit | FW vers. |
| ON | All measurements and generators are releasable | – *) | – | V3.60 |
| OFF | All measurements and generators are persistent | | | |
| Command description | | | | |
| This command determines the behavior of the R&S® CMU if conflicting measurements or generators are run in parallel. | | | | |
| *) A reset does not change the task priority management setting. | | | | |

| SYSTem:REMOte:RDMode <Enable> | | Remote Debug Mode | | |
|--|-------------------------------|-------------------|--------------|----------|
| <Enable> | Parameter description | Def. value | Default unit | FW vers. |
| ON | Activate remote debug mode | OFF*) | – | V3.60 |
| OFF | Activate ordinary remote mode | | | |
| Command description | | | | |
| This command enables or disables the remote debug mode. | | | | |
| *) The remote debug mode is not changed after *RST but reset when the CMU is re-started. | | | | |

| SYSTem:REMOte:FORMat:NUMeric <Standard> | | Block Data Format | | |
|--|---|-------------------|-----------|----------|
| Standard | Parameter description | Def. value | Def. unit | FW vers. |
| IEEE754 | Data is transferred in a definite length block as IEEE floating point numbers of the specified <length>*). Numeric data is transferred as ASCII bytes. The number are separated by commas as specified in IEEE 488.2. | SCPI | – | V4.00 |
| SCPI | | | | |
| Command description | | | | |
| This command selects the format for numeric data transferred to and from the analyzer. The format setting is only valid for commands and queries which are explicitly designed for the transfer of binary data, e.g. READ:BINary:ARRay:IQRecorder:PHASe? This command has no equivalent in manual control. | | | | |
| *) See description of block data format in Chapter 5. | | | | |

| SYSTem:REMOte:FORMat:BORDER <Byte Order> | | Byte Order | | |
|---|--|------------|-----------|----------|
| Returned value | Parameter description | Def. value | Def. unit | FW vers. |
| NORMAL | The least significant bit is transferred first (little endian) | NORMAL | – | V4.00 |
| SWAPped | The most significant bit is transferred first (big endian) | | | |
| Command description | | | | |
| This command controls whether binary data is transferred in normal or swapped byte order. This command has no equivalent in manual control. | | | | |

Subsystem Communicate

The *COMMunicate* subsystem contains the commands for configuration of the remote serial interfaces. It corresponds to the *Communicate* tab in the *Setup* menu opened via the *SETUP* key on the front panel. The parameters set in this subsystem are explained in more detail in chapter 8, section *Hardware Interfaces*.

| SYSTem:COMMunicate:GPIB[:SELF]:ADDRess <Addr> | | | | Primary Address |
|---|--|------------|--------------|-----------------|
| <Addr> | Parameter description | Def. value | Default unit | FW vers. |
| 0 to 30 | Primary address to the GPIB (IEEE) bus | 20 | – | V1.20 |
| Command description | | | | |
| This command sets the primary address of the GPIB driver which is used to address the device (R&S® CMU). It is equivalent to SYSTem:REMOte:ADDRess:PRIMary (see above). | | | | |

| SYSTem:COMMunicate:SERial<1 2>:APPLication? | | | | Application |
|--|--|--|--------------|-------------|
| Response | Parameter description | Def. value | Default unit | FW vers. |
| TRAN REM PRIN | Transfer Remote control Printer control (future extension) | dep. on SCPI connection (port) and printer set- tings | - | V1.20 |
| Command description | | | | |
| This command is always a query. It returns the current application (connection) of the serial (RS-232) interface. The numeric suffix distinguishes the two interfaces COM 1 and COM 2. | | | | |

| SYSTem:COMMunicate:SERial<1 2>[:RECeive]:BAUD <Baudrate> | | | | Baud Rate |
|---|-----------------------|------------|--------------|-----------|
| <Baudrate> | Parameter description | Def. value | Default unit | FW vers. |
| 110 300 600 1200 2400 4800 9600 19200 38400 57600 115200 | baud rate | 9600 | baud | V1.20 |
| Command description | | | | |
| This command sets the baud rate of the serial interface no. 1 or 2 (connectors COM 1 or COM 2). If a COM port is selected as GPIB connector, the default transmission rate is 19200 baud. | | | | |

| SYSTem:COMMunicate:SERial<1 2>[:RECeive]:BITS <DataBits> | | | | Data Bits |
|--|-----------------------|------------|--------------|-----------|
| <DataBits> | Parameter description | Def. value | Default unit | FW vers. |
| 7 8 | number of data bits | 8 | – | V1.20 |
| Command description | | | | |
| This command sets the number of data bits of the serial interface no. 1 or 2 (connectors COM 1 or COM 2). The default value is 7 if the serial interface is used for data transfer (see SYSTem:COMMunicate:SERial<1 2>:APPLication?). The sum of data bits and stop bits must be equal to 9. | | | | |

| SYSTem:COMMunicate:SERial<1 2>[:RECeive]:STOP <StopBits> | | | | Stop bits |
|--|-----------------------|------------|--------------|-----------|
| <StopBits> | Parameter description | Def. value | Default unit | FW vers. |
| 1 2 | number of stop bits | 1 | - | V1.20 |
| Command description | | | | |
| This command sets the number of stop bits of the serial interface no. 1 or 2 (connectors COM 1 or COM 2). The default value is 2 if the serial interface is used for data transfer (see SYSTem:COMMunicate:SERial<1 2>:APPLication?). The sum of data bits and stop bits must be equal to 9. | | | | |

| SYSTem:COMMunicate:SERial<1 2>[:RECeive]:PARity[:TYPE] <Parity> | | | | Parity |
|--|--|------------|--------------|----------|
| <Parity> | Parameter description | Def. value | Default unit | FW vers. |
| NONE ODD EVEN | no parity odd parity even parity | NONE | - | V1.20 |
| Command description | | | | |
| This command sets the parity of the serial interface no. 1 or 2 (connectors COM 1 or COM 2). | | | | |

| SYSTem:COMMunicate:SERial<1 2>:TRANsmit:PACE <Pace> | | | | Transmission Protocol |
|--|--|------------|--------------|-----------------------|
| <Pace> | Parameter description | Def. value | Default unit | FW vers. |
| XON ACK NONE | Xon/Xoff – protocol Hardware protocol with CTS/RTS lines No protocol set | XON | - | V1.20 |
| Command description | | | | |
| This command sets the handshake protocol of the serial interface no. 1 or 2 (connectors COM 1 or COM 2). | | | | |

Subsystem Options

The *Options* subsystem contains the commands for querying information on the instrument and the available options. It corresponds to the *Options* tab in the *Setup* menu opened via the *SETUP* key on the front panel.

| SYSTem:OPTions:INFO? | | | Device Info |
|---|------------|--------------|-------------|
| Response | Def. value | Default unit | FW vers. |
| Example: ROHDE&SCHWARZ, CMU 200,840675/018,V3.50B 2003-01-30 | - | - | V1.20 |
| Command description | | | |
| This command returns the information on the device comprising the manufacturer, model, serial number and base system firmware version. This command is always a query and is equivalent to the common command *IDN? | | | |

| SYSTem:OPTions? | | | | Options |
|--|--|------------|-----------|----------|
| Response | Parameter description | Def. value | Def. unit | FW vers. |
| HWO, "B11/12","B11", "B17",NAN, "B21","available",... | Identifier for hardware options 1 st option, 2 nd option, not available. 3 rd option, available | – | – | V1.20 |
| SWO, "K0",NAN, "K20","enabled", "K21","3x10.c05 available", | Identifier for software options 1 st option, not available 2 nd option, enabled 3 rd option, available but not enabled | | | |
| HWE, "CPU(FMR)", "FMR5" ... | Identifier for hardware equipment 1 st equipment ... | | | |
| FWV, „uP1“,“V7.00 26.08.02”, "uP2",NAN | Identifier for firmware versions 1 st option, 2 nd option, 3, 4 ... | | | |
| Command description | | | | |
| This command returns a list of all options and equipment available in the instrument, equivalent to the list overview in the <i>Setup – Options</i> tab. It is always a query. An alternative list of options (following IEEE 488.2 conventions) can be queried via the common command *OPT? | | | | |

Subsystem Time

The *Time* subsystem contains the commands for the current time and date. It corresponds to the *Time* tab in the *Setup* menu opened via the *SETUP* key on the front panel.

| SYSTem[:TIME]:TZONe <Hour>[,<Minute>] | | | | Time Zone |
|---|-----------------------------------|------------|--------------|-----------|
| Parameters | Parameter description | Def. value | Default unit | FW vers. |
| <Hour> | Integer value between –12 and +12 | +1 | – | V1.20 |
| <Minute> | -59 to +59 (optional) | 0 | | |
| Command description | | | | |
| This command defines the time zone via the time offset from Greenwich mean time. A time offset of +1 h (default setting) corresponds to Middle European time. | | | | |

| SYSTem[:TIME]:TIME <Hour>,<Minute>,<Second> | | | | Current Time |
|---|---|-------------|---------------|--------------|
| Parameters | Parameter description | Def. value | Default unit | FW vers. |
| <Hour>, <Minute>, <Second> | Hours (0 to 23) Minutes (0 to 59) Seconds (0 to 59) | – – – | h min s | V1.20 |
| Command description | | | | |
| This command sets the internal system time of the R&S® CMU. | | | | |

| SYSTEM[:TIME]:DATE <Year>,<Month>,<Day> | | | | Date |
|--|--|-------------|--------------|----------|
| Parameters | Parameter description | Def. value | Default unit | FW vers. |
| <Year>, <Month>, <Day> | Four-digit year (1980 to 2099) Month (1 to 12) Day (1 to 31) | – – – | – | V1.20 |
| Command description | | | | |
| This command sets the internal system date of the R&S® CMU. | | | | |

Subsystem MISC

The *MISC* subsystem sets the acoustic signal and selecting the external keyboard assignment. It corresponds to the *Misc.* tab in the *Setup* menu opened via the *SETUP* key on the front panel.

| SYSTEM:MISC:KBEep <Enable> | | | | Key Beep |
|--|-----------------------|------------|--------------|----------|
| <Enable> | Parameter description | Def. value | Default unit | FW vers. |
| ON OFF | Key beep on or off | OFF | – | V1.20 |
| Command description | | | | |
| This command switches the acoustic signal of the R&S® CMU on or off. | | | | |

| SYSTEM:MISC:KEYBoard <Country> | | | | Keyboard |
|--|--------------------------------------|------------|--------------|----------|
| <Country> | Parameter description | Def. value | Default unit | FW vers. |
| US GR | American keyboard German keyboard | US | – | V1.20 |
| Command description | | | | |
| This command selects the driver for the external keyboard. | | | | |

Subsystem TCPip (TCP/IP Addressing)

The commands in this section configure the R&S CMU with the IP address information necessary for communicating with other hosts and applications through an IP network. The commands correspond to the *TCP/IP* tab of the *Setup* menu.

Note: *The TCP/IP information is not changed after a reset (*RST) of the instrument. The default values (factory settings) can be restored using `SYSTEM:TCPip:PRIMARY:DEFAULT ON` or `SYSTEM:TCPip:SECONDARY:DEFAULT ON`.*

| SYSTEM:TCPip:PRIMARY:DEFAULT <Enable> | | Default Settings | | |
|--|--|------------------|-----------|----------|
| <Enable> | Description of parameters | Def. value | Def. unit | FW vers. |
| ON OFF | The parameters are set to their default values (factory settings) Some or all parameters differ from their default values | ON | – | V3.80 |
| Description of command | | | | |
| If used as a setting command with the parameter <i>ON</i> , this command sets all parameters of the TCP/IP addressing commands for the signalling unit R&S CMU-B21 V14 to their default values (the setting <i>OFF</i> results in an error message). If used as a query, the command returns whether all parameters are set to their default values (<i>ON</i>) or not (<i>OFF</i>). | | | | |

| SYSTEM:TCPip:PRIMARY:STATIC:IPADDRESS | | Static IP Address | | |
|---|------------------------------|-------------------|-----------|----------|
| <IP Address 1>, <IP Address 2>, <IP Address 3>, <IP Address 4> | | | | |
| <IP Address 1> | Description of parameters | Def. value | Def. unit | FW vers. |
| 0 to 255, | First segment of IP address | 192 | – | V3.80 |
| <IP Address 2> | Description of parameters | Def. value | Def. unit | FW vers. |
| 0 to 255, | Second segment of IP address | 168 | – | V3.80 |
| <IP Address 3> | Description of parameters | Def. value | Def. unit | FW vers. |
| 0 to 255, | Third segment of IP address | 168 | – | V3.80 |
| <IP Address 4> | Description of parameters | Def. value | Def. unit | FW vers. |
| 0 to 255 | Fourth segment of IP address | 170 | – | V3.80 |
| Description of command | | | | |
| This command sets the static IP address of the signalling unit R&S CMU-B21 V14. | | | | |

| SYSTEM:TCPip:PRIMARY:STATIC:SMASK | | Static Subnet Mask | | |
|--|-------------------------------|--------------------|-----------|----------|
| <Subnet Mask 1>, <Subnet Mask 2>, <Subnet Mask 3>, <Subnet Mask 4> | | | | |
| <Subnet Mask 1> | Description of parameters | Def. value | Def. unit | FW vers. |
| 0 to 255, | First segment of subnet mask | 255 | – | V3.80 |
| <Subnet Mask 2> | Description of parameters | Def. value | Def. unit | FW vers. |
| 0 to 255, | Second segment of subnet mask | 255 | – | V3.80 |
| <Subnet Mask 3> | Description of parameters | Def. value | Def. unit | FW vers. |
| 0 to 255, | Third segment of subnet mask | 0 | – | V3.80 |
| <Subnet Mask 4> | Description of parameters | Def. value | Def. unit | FW vers. |
| 0 to 255 | Fourth segment of subnet mask | 0 | – | V3.80 |
| Description of command | | | | |
| This command sets the static subnet mask of the signalling unit R&S CMU-B21 V14. | | | | |

| SYSTem:TCPip:PRIMary:STATic:DGATeway | | Static Default Gateway | | |
|--|-----------------------------------|------------------------|-----------|----------|
| <Gateway 1>, <Gateway 2>, <Gateway 3>, <Gateway 4> | | | | |
| <Gateway 1> | Description of parameters | Def. value | Def. unit | FW vers. |
| 0 to 255, | First segment of default gateway | 192 | – | V3.80 |
| <Gateway 2> | Description of parameters | Def. value | Def. unit | FW vers. |
| 0 to 255, | Second segment of default gateway | 168 | – | V3.80 |
| <Gateway 3> | Description of parameters | Def. value | Def. unit | FW vers. |
| 0 to 255, | Third segment of default gateway | 0 | – | V3.80 |
| <Gateway 4> | Description of parameters | Def. value | Def. unit | FW vers. |
| 0 to 255 | Fourth segment of default gateway | 1 | – | V3.80 |
| Description of command | | | | |
| This command sets the static default gateway of the signalling unit R&S CMU-B21 V14. | | | | |

| SYSTem:TCPip:SECOndary:DEFault <Enable> | | Default Settings | | |
|--|--|------------------|-----------|----------|
| <Enable> | Description of parameters | Def. value | Def. unit | FW vers. |
| ON OFF | The parameters are set to their default values (factory settings) Some or all parameters differ from their default values | ON | – | V3.80 |
| Description of command | | | | |
| When used as a setting command with the parameter <i>ON</i> , this command sets all parameters of the TCP/IP addressing commands for the signalling unit R&S CMU-B83 to their default values (the setting <i>OFF</i> results in an error message). When used as a query, the command returns whether all parameters are set to their default values (<i>ON</i>) or not (<i>OFF</i>). | | | | |

| SYSTem:TCPip:SECOndary:MODE <Mode> | | Type of CMU IP Addressing | | |
|---|---|--|-----------|----------|
| <Mode>, settings | Description of parameters | Def. value | Def. unit | FW vers. |
| STAT DYN | Manual assignment of IP address Automatic assignment using DHCP | STATic | – | V3.80 |
| <Mode>, query | Description of parameters | Def. value | Def. unit | FW vers. |
| STAT DYN PEND UDEF | Manual or automatic assignment DHCP Procedure Pending, no change of IP addressing mode possible DHCP Failure (IP Connection Undefined); bit 14 of the event status register is set. | STATic | – | V3.80 |
| Description of command | | | | |
| This command specifies whether the IP address information is assigned manually or automatically. The command can also be used to query the <i>DHCP Procedure Pending</i> and <i>IP Connection Undefined</i> states. | | | | |
| The type of IP addressing is not changed after a *RST. The following error messages may be generated: | | | | |
| –221,"Setting conflict" | | The IP addressing mode is changed while packet data is active. | | |
| –213,"Init ignored" | | The IP addressing mode is changed while the DCHP procedure is pending. | | |

| SYSTEM:TCPIP:SECondary:STATIC:IPADdress | | | | Static IP Address | |
|---|------------------------------|------------|-----------|-------------------|--|
| <i><IP Address 1>, <IP Address 2>, <IP Address 3>, <IP Address 4></i> | | | | | |
| <IP Address 1> | Description of parameters | Def. value | Def. unit | FW vers. | |
| 0 to 255, | First segment of IP address | 192 | – | V3.80 | |
| <IP Address 2> | Description of parameters | Def. value | Def. unit | FW vers. | |
| 0 to 255, | Second segment of IP address | 168 | – | V3.80 | |
| <IP Address 3> | Description of parameters | Def. value | Def. unit | FW vers. | |
| 0 to 255, | Third segment of IP address | – | – | V3.80 | |
| <IP Address 4> | Description of parameters | Def. value | Def. unit | FW vers. | |
| 0 to 255 | Fourth segment of IP address | – | – | V3.80 | |
| Description of command | | | | | |
| This command sets the static IP address of the CMU. The factory setting for the address depends on the CMU serial number. | | | | | |

| SYSTEM:TCPIP:SECondary:STATIC:SMASK | | | | Static Subnet Mask | |
|---|-------------------------------|------------|-----------|--------------------|--|
| <i><Subnet Mask 1>, <Subnet Mask 2>, <Subnet Mask 3>, <Subnet Mask 4></i> | | | | | |
| <Subnet Mask 1> | Description of parameters | Def. value | Def. unit | FW vers. | |
| 0 to 255, | First segment of subnet mask | 255 | – | V3.80 | |
| <Subnet Mask 2> | Description of parameters | Def. value | Def. unit | FW vers. | |
| 0 to 255, | Second segment of subnet mask | 255 | – | V3.80 | |
| <Subnet Mask 3> | Description of parameters | Def. value | Def. unit | FW vers. | |
| 0 to 255, | Third segment of subnet mask | 0 | – | V3.80 | |
| <Subnet Mask 4> | Description of parameters | Def. value | Def. unit | FW vers. | |
| 0 to 255 | Fourth segment of subnet mask | 0 | – | V3.80 | |
| Description of command | | | | | |
| This command sets the static subnet mask of the CMU. | | | | | |

| SYSTEM:TCPIP:SECondary:STATIC:DGATeway | | | | Static Default Gateway | |
|---|-----------------------------------|------------|-----------|------------------------|--|
| <i><Gateway 1>, <Gateway 2>, <Gateway 3>, <Gateway 4></i> | | | | | |
| <Gateway 1> | Description of parameters | Def. value | Def. unit | FW vers. | |
| 0 to 255, | First segment of default gateway | 192 | – | V3.80 | |
| <Gateway 2> | Description of parameters | Def. value | Def. unit | FW vers. | |
| 0 to 255, | Second segment of default gateway | 168 | – | V3.80 | |
| <Gateway 3> | Description of parameters | Def. value | Def. unit | FW vers. | |
| 0 to 255, | Third segment of default gateway | 0 | – | V3.80 | |
| <Gateway 4> | Description of parameters | Def. value | Def. unit | FW vers. | |
| 0 to 255 | Fourth segment of default gateway | 1 | – | V3.80 | |
| Description of command | | | | | |
| This command sets the static default gateway of the CMU. | | | | | |

| SYSTem:TCPip:SECondary:DYNamic:HNAME <Name> | | Dynamic Addressing: Host name | | |
|---|---|-------------------------------|-----------|----------|
| <Name> | Description of parameters | Def. value | Def. unit | FW vers. |
| '<max. 32 characters>' | Hostname assigned to the CMU, string variable | 'CMU200' | – | V3.80 |
| Description of command | | | | |
| This command sets the hostname that is assigned to the CMU and transferred to the DHCP server if dynamic IP addressing is selected (SYSTem:TCPip:SECondary:DYNamic:IPADdress:MODE DYNamic). | | | | |

| [SENSe:]IPADdress:FCODE? | | Dynamic Addressing: Failure Code | | |
|--|---------------------------|----------------------------------|-----------|----------|
| Response | Description of parameters | Def. value | Def. unit | FW vers. |
| 0 | No error | 0 | – | V3.80 |
| -1 | Dyn. Event Failed | | | |
| -2 | No Target IP Allocated | | | |
| -3 | Interface Down | | | |
| -4 | No Router IP Allocated | | | |
| -5 | Mobile Home IP Addr. | | | |
| -6 | Bind Failure | | | |
| Description of command | | | | |
| This command is always a query and returns the possible cause for an error during dynamic allocation of the CMU's IP address. The response is 0 unless dynamic IP address allocation failed (in which case the query SYSTem:TCPip:SECondary:DYNamic:IPADdress:MODE? returns UDEF). | | | | |

| SYSTem:TCPip:SECondary:DYNamic:DNS? | | Dynamic Domain Name Server | | |
|--|---------------------------|----------------------------|-----------|----------|
| <DNS 1>, <DNS 2>, <DNS 3>, <DNS 4> | | | | |
| <IP Address 1> | Description of parameters | Def. value | Def. unit | FW vers. |
| 0 to 255, | First segment of DNS | INV | – | V3.80 |
| <IP Address 2> | Description of parameters | Def. value | Def. unit | FW vers. |
| 0 to 255, | Second segment of DNS | INV | – | V3.80 |
| <IP Address 3> | Description of parameters | Def. value | Def. unit | FW vers. |
| 0 to 255, | Third segment of DNS | INV | – | V3.80 |
| <IP Address 4> | Description of parameters | Def. value | Def. unit | FW vers. |
| 0 to 255 | Fourth segment of DNS | INV | – | V3.80 |
| Description of command | | | | |
| This command sets the dynamically acquired CMU Domain Name Server. | | | | |

| SYSTEM:TCPip:SECondary:DYNamic:IPAdDress? | | Dynamic IP Address | | |
|---|------------------------------|--------------------|-----------|----------|
| <i><IP Address 1>, <IP Address 2>, <IP Address 3>, <IP Address 4></i> | | | | |
| <IP Address 1> | Description of parameters | Def. value | Def. unit | FW vers. |
| 0 to 255, | First segment of IP address | INV | – | V3.80 |
| <IP Address 2> | Description of parameters | Def. value | Def. unit | FW vers. |
| 0 to 255, | Second segment of IP address | INV | – | V3.80 |
| <IP Address 3> | Description of parameters | Def. value | Def. unit | FW vers. |
| 0 to 255, | Third segment of IP address | INV | – | V3.80 |
| <IP Address 4> | Description of parameters | Def. value | Def. unit | FW vers. |
| 0 to 255 | Fourth segment of IP address | INV | – | V3.80 |
| Description of command | | | | |
| This command sets the dynamically acquired IP address of the CMU. | | | | |

| SYSTEM:TCPip:SECondary:DYNamic:SMASK? | | Dynamic Subnet Mask | | |
|---|-------------------------------|---------------------|-----------|----------|
| <i><Subnet Mask 1>, <Subnet Mask 2>, <Subnet Mask 3>, <Subnet Mask 4></i> | | | | |
| <Subnet Mask 1> | Description of parameters | Def. value | Def. unit | FW vers. |
| 0 to 255, | First segment of subnet mask | INV | – | V3.80 |
| <Subnet Mask 2> | Description of parameters | Def. value | Def. unit | FW vers. |
| 0 to 255, | Second segment of subnet mask | INV | – | V3.80 |
| <Subnet Mask 3> | Description of parameters | Def. value | Def. unit | FW vers. |
| 0 to 255, | Third segment of subnet mask | INV | – | V3.80 |
| <Subnet Mask 4> | Description of parameters | Def. value | Def. unit | FW vers. |
| 0 to 255 | Fourth segment of subnet mask | INV | – | V3.80 |
| Description of command | | | | |
| This command sets the dynamically acquired subnet mask of the CMU. | | | | |

| SYSTEM:TCPip:SECondary:DYNamic:DGATeway? | | Dynamic Default Gateway | | |
|---|-----------------------------------|-------------------------|-----------|----------|
| <i><Gateway 1>, <Gateway 2>, <Gateway 3>, <Gateway 4></i> | | | | |
| <Gateway 1> | Description of parameters | Def. value | Def. unit | FW vers. |
| 0 to 255, | First segment of default gateway | INV | – | V3.80 |
| <Gateway 2> | Description of parameters | Def. value | Def. unit | FW vers. |
| 0 to 255, | Second segment of default gateway | INV | – | V3.80 |
| <Gateway 3> | Description of parameters | Def. value | Def. unit | FW vers. |
| 0 to 255, | Third segment of default gateway | INV | – | V3.80 |
| <Gateway 4> | Description of parameters | Def. value | Def. unit | FW vers. |
| 0 to 255 | Fourth segment of default gateway | INV | – | V3.80 |
| Description of command | | | | |
| This command sets the dynamically acquired default gateway of the CMU. | | | | |

Subsystem GTRMode (Local to Remote Switchover)

The *GTRMode* subsystem determines the behavior of the R&S® CMU in a local to remote transition. The settings are provided in the *Remote* tab of the *Setup* menu.

| SYSTEM:GTRMode:COMPAtible <Enable> | | Local to Remote | | |
|---|---|-----------------|--------------|----------|
| <Enable> | Parameter description | Def. value | Default unit | FW vers. |
| ON | Connection or call dropped on local to remote switchover/ generator switched off | ON | – | V3.05 |
| OFF | Current signalling state or generator state maintained | | | |
| Command description | | | | |
| This command defines the behavior of the R&S® CMU in a local to remote transition. The command is valid for all function groups and test modes, however, its effect depends on the test mode (<i>Signalling</i> or <i>Non Signalling</i> tests): | | | | |
| <i>Signalling</i> | In the <i>ON</i> setting, the connection or call is dropped and the R&S® CMU returns to its default signalling state (e.g. <i>SBY</i> in the <i>Bluetooth Signalling</i> function group). In the <i>OFF</i> setting, all signalling states are maintained. This makes it possible to switch the instrument to remote control without dropping a call or connection. See also operating manuals for the different network tests. | | | |
| <i>Non Signalling</i> | In the <i>ON</i> setting, all generators are switched off. In the <i>OFF</i> setting, the current operating state of all generators is maintained. | | | |

| *GTL | Go to Local |
|---|-------------|
| Command description | |
| This command has no query form. It switches the instrument immediately back to local mode (manual control). The R&S® CMU opens the menu of the current running measurement; see also section <i>Return to Manual Control</i> in Chapter 5. This command can be used instead of the addressed command <i>GTL</i> if a serial connection is used. | |

Subsystem MQUeue

The *MQUeue* subsystem contains the commands for symbolic measurement ready evaluation. These commands are used to query the contents of the measurement queue. To activate the measurement queue, event reporting must not be switched off; see section *Event Reporting* in Chapter 5.

| SYSTEM:MQUeue[:COMPLete][:LIST]? | | Complete Measurement Queue | | |
|---|---|----------------------------|--------------|----------|
| Response | Parameter description | Def. value | Default unit | FW vers. |
| <FGroup_Mode>, <MeasObject>, ... | Function group and test mode Ready measurement | "NONE", "NONE" | – | V2.10 |
| Command description | | | | |
| This command is always a query. It returns and deletes the contents of the complete measurement queue. The individual results are returned in chronological order (first in first out). Examples of possible responses are: | | | | |
| 'RF_NSig','POWer','RF_NSig','SPECtrum' Power and spectrum measurement ready in function group <i>RF Non Signalling</i> , | | | | |
| "NONE", "NONE" No ready measurements reported | | | | |

| SYSTEM:MQueue[:COMPLETE]:ITEM? | | Next Entry in Measurement Queue | | |
|---|---|---------------------------------|--------------|----------|
| <i>Response</i> | Parameter description | Def. value | Default unit | FW vers. |
| <FGroup_Mode>, <MeasObject> | Function group and test mode Ready measurement | "NONE", "NONE" | – | V2.10 |
| Command description | | | | |
| This command is always a query. It returns and deletes the oldest ready measurement in the measurement queue. | | | | |

Reset of Function Groups

The *PRESet/RESet* subsystem restores the (factory) default values for all instrument settings. It corresponds to the *Reset* menu opened via the *RESET* key on the front panel.

| SYSTEM:PRESet[:ALL] SYSTEM:RESet[:ALL] | | Reset all function groups and test modes | |
|--|--|--|----------|
| Command description | | | FW vers. |
| This command sets all parameters of the instrument to default values. The commands differ for instrument settings with distinct default values in manual and remote control (e.g. the repetition mode for many measurements): <i>SYST:PREs</i> restores the default values for manual control, leaving the current remote control parameters unchanged. <i>SYST:RES</i> (available for FW vers. ≥3.10) restores the default values for remote control leaving the current manual control parameters unchanged. This command is equivalent to <i>*RST</i> . | | | V1.20 |

| SYSTEM:RESet:CURRENT | | Partial Reset |
|--|--|---------------|
| Command description | | FW vers. |
| This command sets all parameters of the current function group and test mode to default values. The command is available in all function groups. In contrast to the <i>Reset</i> menu the command restores the default values defined for remote control operation. In cases where remote and manual control use distinct settings (e.g. the repetition mode for many measurements), the manual control settings are left unchanged. | | V3.10 |

Remote Report – Subsystem TRACe

The TRACe subsystem determines whether the remote report is displayed on screen or written to a file. It corresponds to the *Report...* hotkeys on the bottom of the *Remote* screen.

| *LLO <Boolean> | | | | Local Lockout |
|--|---|------------|--------------|---------------|
| <Boolean> | Parameter description | Def. value | Default unit | FW vers. |
| FALSe TRUE | Hitting any front panel key switches to manual control Front panel keys locked | FALSe | – | V3.10 |
| Command description | | | | |
| This command has no query form. It locks the front panel keys to prevent an inadvertent switchover to manual control. If TRUE is set, the hotkeys to control the remote screen are still active. The parameter FALSe re-activates all front panel keys for switchover to manual control. | | | | |
| This command can be used instead of the universal command LLO if a serial connection is used. | | | | |

| TRACe:REMOte:MODE:DISPlay <Enable> | | | | Report Display |
|--|--|------------|--------------|----------------|
| <Enable> | Parameter description | Def. value | Default unit | FW vers. |
| ON OFF | Remote report displayed on screen Remote report not displayed | OFF | – | V3.05 |
| Command description | | | | |
| This command qualifies whether the remote report is displayed on screen. The remote report is a useful debugging tool. | | | | |

| TRACe:REMOte:MODE:DISPlay:FILTer <Enable> | | | | Report Mode |
|--|--|------------|-----------|-------------|
| <Enable> | Description of parameters | Def. value | Def. unit | FW vers. |
| ON OFF | Report Mode: Results Report Mode: All (no command filter) | OFF | – | V4.51 |
| Description of command | | | | |
| This command defines the report mode in the remote control screen. | | | | |

| TRACe:REMOte:MODE:FILE <Enable> | | | | Report File |
|---|--|------------|--------------|-------------|
| <Enable> | Parameter description | Def. value | Default unit | FW vers. |
| ON OFF | Remote report stored Remote report not stored | OFF | – | V3.05 |
| Command description | | | | |
| This command qualifies whether the remote report is written to a file named Remote.trc in the INTERNAL directory of the internal hard disk. | | | | |

| TRACe:REMOte:MODE:ERRor <Enable> | | | | Show/Hide Error Messages |
|---|-----------------------------|------------|--------------|--------------------------|
| <Enable> | Parameter description | Def. value | Default unit | FW vers. |
| ON OFF | Show or hide error messages | ON | – | V3.08 |
| Command description | | | | |
| This command qualifies whether error messages (marked by a "E !" symbol on a red square) are included in the remote report. | | | | |

| TRACe:REMOte:MODE:SRQ <Enable> | | Show/Hide Service Requests | | |
|--|-----------------------|----------------------------|--------------|----------|
| <Enable> | Parameter description | Def. value | Default unit | FW vers. |
| ON OFF | Show or hide SRQs | OFF | – | V3.08 |
| Command description | | | | |
| This command qualifies whether a message is written to the remote report whenever the R&S® CMU sends a service request to the controller. The message symbolizes the contents of the status byte (e.g. ERR, OPR, MAV, OPER,...) and is marked by a red "S" symbol. | | | | |

| TRACe:REMOte:MODE:OUTLines <Enable> | | Report Lines for Output | | |
|---|-------------------------|-------------------------|--------------|----------|
| <Enable> | Parameter description | Def. value | Default unit | FW vers. |
| 1 to 4 | Maximum number of lines | 4 | – | V3.08 |
| Command description | | | | |
| This command defines the maximum number of lines available for each output string in the remote report screen. If the output string of a query (e.g. READ:ARRay:POWer? in the RF function group) is longer than the specified number of lines, it is truncated and the last three characters are replaced by "...". | | | | |

File Manager – System MMEMOry

The MMEMOry system provides mass storage capabilities for the R&S® CMU. Part of the functionality of this system is included in the *Data* menu.

The mass storage of the CMU may be internal or external. The internal mass storage device is a section on the internal hard disk that is reserved for mass storage (directory c:\temp). The external mass storage device is either a floppy disk or a CF / PCMCIA memory card, depending on the instrument configuration. The <msus> (mass storage unit specifier) parameter in the MMEMOry commands denotes the root directory of the INTernal or EXTernal mass storage device.

The <FileName> parameter is a string. The contents of the string may contain characters for specifying subdirectories, e.g. "\TEMP\TRASH\test.txt" for the file named *test.txt* in the TEMP\TRASH subdirectory of the root directory or "TEMP\TRASH\test.txt" for the file named *test.txt* in the TEMP\TRASH subdirectory of the current directory, to be queried with MMEMOry:DIRectory [:CURRent]?. The file name itself may contain the period as a separator for extensions.

Unless otherwise stated, all the following commands are SCPI-confirmed.

| MMEemory:INFO? <FileName> [,<msus>] | | | | View Info |
|---|---|---------------------------|--|-----------|
| <FileName> | Parameter description | Def. value | Def. unit | |
| "<8 dig.max>.<3dig.>" | Name of the file to be inquired in DOS (8.3) convention. | – | – | |
| <msus> | Parameter description | Def. value | Def. unit | |
| INTernal EXTernal | Internal memory (hard disk) External memory (floppy disk or CF / PCMCIA memory card) | INTernal ⁵ | – | |
| Returned info | Parameter description | Def. value | Def. unit | FW vers. |
| <Year>,<Month>,<Day>, <Hour>,<Min>,<Sec>, <Size>, <Version>, "<Comment>" | Date when the file was stored Time when the file was stored File size in byte File version number Comment string stored with the file | – – – " " " " | y, m, d h, min, s byte – – | V3.05 |
| Description of command | | | | |
| <p>This command retrieves information about a file stored on the external or internal mass memory. The <msus> parameter must be specified if information on an external file is needed and the internal memory contains a file of the same name. Alternatively, <i>msus</i> may be specified with the command MMEemory:MSIS [<msus>].</p> <p>This command is R&S® CMU-specific. The <Version> and <Comment> output parameters are reserved for future extensions.</p> | | | | |

| MMEemory:COMMeNT <Comment> | | | | Comment |
|---|-----------------------|------------|-----------|----------|
| <Comment> | Parameter description | Def. value | Def. unit | FW vers. |
| "<160 characters max.>" | Comment string | " " | – | V3.10 |
| Description of command | | | | |
| <p>This command defines a comment for a R&S® CMU configuration file. The comment is saved to the file generated via <code>MMEemory:SAVE[:ALL] <FileName>[,<msus>]</code> or <code>MMEemory:SAVE:CURRENT <FileName>[,<msus>]</code>. The command is R&S® CMU-specific.</p> | | | | |

| MMEemory:MSIS [<msus>] | | | | Internal/External |
|--|---|------------|-----------|-------------------|
| <msus> | Parameter description | Def. value | Def. unit | FW vers. |
| INTernal EXTernal | Internal memory (hard disk) External memory (floppy disk or CF / PCMCIA memory card) | INTernal | – | V3.05 |
| Description of command | | | | |
| <p>This <i>Mass Storage IS</i> command resets the default mass storage parameter <msus> for all MMEemory commands.</p> | | | | |

⁵ See MMEemory:MSIS [<msus>] setting.

| MMEemory:DIRectory[:CURRent]? | | | Current Directory | |
|--|--|-------------------------------------|-------------------|----------|
| Returned value | Parameter description | Def. value | Def. unit | FW vers. |
| INT EXT, "<DirectoryName>" | Internal or external storage device Name and path of the current directory in DOS convention. | INT ⁶ "USERDATA\SAVE" | – | V3.05 |
| Description of command | | | | |
| <p>This command is always a query and returns the current directory name and path. Possible return strings are INT, " " (for the internal root directory) or INT, "\TEMP\TRASH" (for the \TEMP\TRASH subdirectory of the internal root directory). This command is R&S® CMU-specific.</p> <p>The current directory is set to default when the base system is booted but left unchanged when the base system is reset (*RST, SYSTem:RESet:CURRent).</p> | | | | |

| MMEemory:CDIRectory [<DirName>], [<msus>] | | | Change Directory | |
|---|---|-----------------|------------------|----------|
| <DirName> | Parameter description | Def. value | Def. unit | FW vers. |
| "<DirectoryName>", INTernal EXTernal | Name of the directory to be accessed Internal or external storage device | "USERDATA\SAVE" | – | V3.05 |
| Description of command | | | | |
| <p>This command has no query form. It sets the directory specified via <DirName> as default directory. If this parameter is omitted, the directory is set to the USERDATA\SAVE subdirectory of the INTernal or EXTernal root directory, depending on the current MMEemory:MSIS [<msus>] settings.</p> | | | | |

| MMEemory:DELeTe <FileName> [<msus>] | | | Delete File | |
|---|--|----------------------------|-------------|----------|
| Parameters | Parameter description | Def. value | Def. unit | FW vers. |
| "<FileName>", INTernal EXTernal | Name of the file to be deleted Storage device of the file to be deleted | – INTernal ⁶ | – – | V3.05 |
| Description of command | | | | |
| <p>This command has no query form. It removes a single file from the specified mass storage device.</p> | | | | |

| MMEemory:RMDir <DirName> [<msus>] | | | Remove Directory | |
|--|--|----------------------------|------------------|----------|
| Parameters | Parameter description | Def. value | Def. unit | FW vers. |
| "<DirectoryName>", INTernal EXTernal | Name of the directory to be removed Storage device of the directory | – INTernal ⁶ | – – | V3.05 |
| Description of command | | | | |
| <p>This command has no query form. It removes a directory with all its contents and subdirectories from the specified mass storage device. The command is R&S® CMU-specific.</p> | | | | |

| MMEemory:MKDir <DirName> [<msus>] | | | Make Directory | |
|--|--|----------------------------|----------------|----------|
| Parameters | Parameter description | Def. value | Def. unit | FW vers. |
| "<DirectoryName>", INTernal EXTernal | Name of the directory to be created Storage device of the directory | – INTernal ⁶ | – – | V3.05 |
| Description of command | | | | |
| <p>This command has no query form. It creates a new subdirectory in the current directory. The command is R&S® CMU-specific.</p> | | | | |

⁶ See MMEemory:MSIS [<msus>] setting.

| MMEMemory:COPY | | | | Copy File |
|--|--|----------------------------|-----------|-----------|
| <FileSource>, <msus1>, <FileDest>, <msus2> <FileSource>, <FileDest> | | | | |
| Parameters | Parameter description | Def. value | Def. unit | FW vers. |
| "<FileSource>", INTernal EXTernal, | Name of the file to be copied Storage device of the source file | – INTernal ⁶ | – – | V3.05 |
| "<FileDest>", INTernal EXTernal | Name of the new file Storage device of the new file | – INTernal ⁶ | – – | |
| Description of command | | | | |
| This command has no query form. It copies the contents of an existing file or directory to a new one. | | | | |

| MMEMemory:MOVE | | | | Move File |
|--|---|----------------------------|-----------|-----------|
| <FileSource>, <msus1>, <FileDest>, <msus2> <FileSource>, <FileDest> | | | | |
| Parameters | Parameter description | Def. value | Def. unit | FW vers. |
| "<FileSource>", INTernal EXTernal, | Name of the file to be renamed Storage device of the source file | – INTernal ⁶ | – – | V3.05 |
| "<FileDest>", INTernal EXTernal | Name of the new file Storage device of the new file | – INTernal ⁶ | – – | |
| Description of command | | | | |
| This command has no query form. It moves an existing file to another file name and mass storage device. | | | | |

| MMEMemory:REName <FileSource>, <FileDest> [, <msus>] | | | | Rename File |
|---|---|----------------------------|-----------|-------------|
| Parameters | Parameter description | Def. value | Def. unit | FW vers. |
| "<FileSource>", INTernal EXTernal, | Name of the file to be renamed Storage device of the source file | – INTernal ⁶ | – – | V3.10 |
| "<FileDest>", INTernal EXTernal | Name of the new file Storage device of the new file | – INTernal ⁶ | – – | |
| Description of command | | | | |
| This command has no query form. It renames an existing file. This command is R&S® CMU-specific. | | | | |

| MMEMemory:SCAN? | | | | Scan Disk |
|--|--|------------|-----------|-----------|
| Rückgabe | Parameter description | Def. value | Def. unit | FW vers. |
| INT EXT, D, "<SubdirectoryName1>", "<SubdirectoryName2>", ... , F, "<FileName1>", "<FileName2>", ... , | Storage device List of subdirectory names List of file names | – | – | V3.05 |
| Description of command | | | | |
| This command is always a query and lists the contents of the current directory. Subdirectories and files are listed in alphabetical order. The first entry specifies the mass storage device (internal or external), entries after "D" denote the subdirectories, entries after "F" denote the files. This command is R&S® CMU-specific. | | | | |

| MMEMory:DATA <FileName> ,<Data> | | | | Transfer Data |
|---|--|------------|-----------|---------------|
| Parameters | Parameter description | Def. value | Def. unit | |
| "<FileName>", <Data> | Name of the destination file | – | – | |
| | Data to be transferred to the R&S® CMU | – | – | |
| Parameters for query | Parameter description | Def. value | Def. unit | FW vers. |
| "<FileName>" | Name of the source file | – | – | V3.05 |
| Description of command | | | | |
| <p>This command loads <data> from the controller into the file <FileName> stored in the current directory of the current R&S® CMU mass storage device. <data> is in 488.2 block format. The data may be transferred via GPIB bus or via serial interface.</p> <p>The query form is MMEMory:DATA? <FileName> with the response being the associated <data> in block format. In this form the command transfers data from the current R&S® CMU mass storage device to the controller.</p> <p>Instead of the entire data transferred the remote protocol contains a string indicating the length of the block data in bytes, e.g. <DEF BLOCK (Length = 19)>.</p> | | | | |

| MMEMory:SAVE[:ALL] <FileName> [,<msus>] | | | | Save all configurations |
|---|--|------------|-----------|-------------------------|
| Parameters | Parameter description | Def. value | Def. unit | FW vers. |
| "<FileName>", INTernal EXTernal | Name of the config. file to be created | – | – | V3.10 |
| | Storage device of the config. file | INTernal | – | |
| Command description | | | | |
| <p>This command saves the configuration of all function groups and test modes to a single configuration file. A "?" in the specified file name will be replaced by current numbers that are automatically incremented, starting with zero. The auto-increment function overwrites an existing file with a "9" in its file name. For instrument settings that may be different in manual and remote control (e.g. the repetition mode for many measurements) the manual setting is saved. This command is R&S® CMU-specific.</p> | | | | |

| MMEMory:SAVE:CURRent <FileName> [,<msus>] | | | | Save configurations in current function group and test mode |
|---|--|------------|-----------|---|
| Parameters | Parameter description | Def. value | Def. unit | FW vers. |
| "<FileName>", INTernal EXTernal | Name of the config. file to be created | – | – | V3.10 |
| | Storage device of the config. file | INTernal | – | |
| Command description | | | | |
| <p>This command saves the configuration of the current function group and test mode to a configuration file. A "?" in the specified file name will be replaced by current numbers that are automatically incremented, starting with zero. The auto-increment function overwrites an existing file with a "9" in its file name. For instrument settings that may be different in manual and remote control (e.g. the repetition mode for many measurements) the manual setting is saved. The command is available in all function groups. This command is R&S® CMU-specific.</p> | | | | |

| MMEMory:RECall[:ALL] <FileName> [,<msus>] | | Recall all configurations | | |
|---|---|---------------------------|-----------|----------|
| Parameters | Parameter description | Def. value | Def. unit | FW vers. |
| "<FileName>", INTernal EXTernal | Name of the config. file to be recalled Storage device of the config. file | – INTernal | – – | V3.10 |
| Command description | | | | |
| This command recalls the configuration of all function groups and test modes stored in a configuration file. This command is R&S® CMU-specific. | | | | |

| MMEMory:RECall:CURRent <FileName> [,<msus>] | | Recall configurations in current function group and test mode | | |
|---|---|---|-----------|----------|
| Parameters | Parameter description | Def. value | Def. unit | FW vers. |
| "<FileName>", INTernal EXTernal | Name of the config. file to be recalled Storage device of the config. file | – INTernal | – – | V3.10 |
| Command description | | | | |
| This command recalls the configuration of the current function group and test mode from a configuration file. The command is available in all function groups. This command is R&S® CMU-specific. | | | | |

Synchronization

The *Synchronize* subsystem contains the commands for configuring the reference frequency. It corresponds to the *Reference Frequency* softkey in the *Sync.* tab of the *Connection Control* menu. Note that this tab is available in every function group.

| CONFigure:SYNChronize:FREQuency:REFerence <Frequency> | | Reference Frequency | | |
|--|-----------------------|---------------------|--------------|----------|
| <Frequency> | Parameter description | Def. value | Default unit | FW vers. |
| 10 kHz to 52 MHz | Reference frequency | 10 MHz | Hz | V1.12 |
| Command description | | | | |
| The command defines the frequency of the synchronization signal. | | | | |

| CONFigure:SYNChronize:FREQuency:REFerence:MODE <Mode> | | Ref. Frequency Source | | |
|--|--|-----------------------|--------------|----------|
| <Mode> | Parameter description | Def. value | Default unit | FW vers. |
| INTernal EXTernal | Internal reference frequency used External reference frequency used | INT | – | V1.12 |
| Command description | | | | |
| The command defines the source of the synchronization signal. After activating the external reference frequency (e.g. after a reset of the base system where the reference frequency is set to INTernal) it is necessary to allow for a setting time (~1 s) until the R&S® CMU has synchronized. The query [SENSe:]SYNChronize:FREQuency:REFerence:LOCKed? indicates whether the reference frequency is locked. A partial reset of all function groups with the exception of the base system does not reset the source of the reference frequency. | | | | |

| [SENSe:]SYNChronize:FREQUENCY:REFerence:LOCKed? | | Ref. Frequency Not Locked | | |
|--|--|---------------------------|-----------|----------|
| Response | Parameter description | Def. value | Def. unit | FW vers. |
| ON OFF | Synchronization to reference frequency achieved Synchronization to reference frequency failed | – | – | V3.10 |
| Command description | | | | |
| This command is always a query. It indicates whether the R&S® CMU is synchronized to the (external) reference frequency. | | | | |
| Note: After activating the external reference frequency (command <i>CONFigure:SYNChronize:FREQUENCY:REFerence:MODE EXTernal</i>) it is necessary to allow for a setting time (~1 s) until the R&S® CMU has synchronized. In this case it is recommended to check whether the reference frequency is locked before starting a measurement in remote control mode. | | | | |

The commands in the USER:CORRection subsystem define the external input and output attenuation factors as a function of the RF input (analyzer) and output (generator) frequency. The commands are valid for all function groups.

| DEFault:USER:CORRection:LOSS <Default Setting> | | Default Setting | | |
|---|--|-----------------|-----------|----------|
| <Default Setting> | Description of parameters | Def. value | Def. unit | FW vers. |
| ON OFF | The parameters are set to default values Some or all parameters are not set to default values | ON | – | V3.60 |
| Description of command | | | | |
| If used as a setting command with the parameter ON, this command sets all parameters of the user correction loss subsystem to their default values (the setting OFF results in an error message). | | | | |
| If used as a query the command returns whether all parameters are set to their default values (ON) or not (OFF). | | | | |

| CONFigure:USER:CORRection:LOSS:TABLE:ENABLE <Enable> | | User Correction Table Enable | | |
|--|--|------------------------------|-----------|----------|
| <Enable > | Description of parameters | Def. value | Def. unit | FW vers. |
| ON OFF | The user correction table is active The user correction table is inactive | OFF | – | V3.60 |
| Description of command | | | | |
| This command enables or disables the entire user correction table. | | | | |

CONFigure:USER:CORRection:LOSS:TABLE? User Correction Loss Table

<Frequency[1]>,<Correction RF1[f1]>,<Correction RF2[f1]>,<Correction RF3-Out[f1]>
,<Correction RF4-In[f1]>
<Frequency[2]>,<Correction RF1[f2]>,<Correction RF2[f2]>,<Correction RF3-Out[f2]>
,<Correction RF4-In[f2]>
,....
<Frequency[50]>,<Correction RF1[f50]>,<Correction RF2[f50]>,<Correction RF3-Out[f50]>
,<Correction RF4-In[f50]>

| Parameters | Description of parameters | Def. value | Def. unit | FW vers. |
|---|--|---------------------------------|----------------------------|----------|
| 10 MHz to 2700 MHz OFF, -50 dB +90 dB OFF, -50 dB +90 dB OFF, -50 dB +90 dB OFF, -50 dB +90 dB OFF, | f ₁ or OFF if no frequency is specified User correction for RF1 @ f ₁ User correction for RF2 @ f ₁ User correction for RF3-Out @ f ₁ User correction for RF4-In @ f ₁ | OFF OFF OFF OFF OFF | Hz dB dB dB dB | V3.60 |
| 10MHz to 2700MHz OFF , -50dB +90dB OFF, -50dB +90dB OFF, -50dB +90dB OFF, -50dB +90dB OFF, | f ₂ or OFF if no frequency is specified User correction for RF1 @ f ₂ User correction for RF2 @ f ₂ User correction for RF3-Out @ f ₂ User correction for RF4-In @ f ₂ | OFF OFF OFF OFF OFF | Hz dB dB dB dB | |
| ... | ... | | ... | |
| 10MHz to 2700MHz OFF, -50dB +90dB OFF, -50dB +90dB OFF, -50dB +90dB OFF, -50dB +90dB OFF | f ₅₀ or OFF if no frequency is specified User correction for RF1 @ f ₅₀ User correction for RF2 @ f ₅₀ User correction for RF3-Out @ f ₅₀ User correction for RF4-In @ f ₅₀ | OFF OFF OFF OFF OFF | Hz dB dB dB dB | |

Description of command

This command is always a query. It returns the whole content of the user correction loss table.

CONFigure:USER:CORRection:LOSS:TABLE:LINE<nr> User Correction at specified frequency

<Frequency[nr]>,<Correction RF1[nr]>,<Correction RF2[nr]>,<Correction RF3-Out[nr]>
,<Correction RF4-In[nr]>

| <Default Setting> | Description of parameters | Def. value | Def. unit | FW vers. |
|--|---|---------------------------------|----------------------------|----------|
| 10MHz to 2700MHz OFF , -50dB +90dB OFF , -50dB +90dB OFF , -50dB +90dB OFF , -50dB +90dB OFF | Correction frequency setting <nr>. Attenuation correction value for RF1<nr>. Attenuation correction value for RF2 <nr>. Attenuation correction value for RF3-Out <nr>. Attenuation correction value for RF4-In <nr> | OFF OFF OFF OFF OFF | Hz dB dB dB dB | V3.60 |

Description of command

This command defines the attenuation correction values for each of the RF connectors at the frequency specified by means of the numeric suffix <nr>.

Note: Setting the frequency to OFF will disable the entire user correction at this frequency .

SORT:USER:CORRection:LOSS:TABLE Sort Table

| Description of command | FW vers. |
|---|----------|
| This command sorts the frequency table. Sorting has no effect to the user correction. | V3.60 |

Display Settings

The `[:WINDow]` subsystem activates the screensaver. All settings are in the *Misc.* tab of the *Setup* menu.

| DISPlay[:WINDow][:STATe] <Enable> | | | | Display |
|---|---------------------------|------------|-----------|----------|
| <Enable> | Description of parameters | Def. value | Def. unit | FW vers. |
| ON OFF | Switch display on or off | ON | – | V3.50 |
| Description of command | | | | |
| This command switches the display of the CMU on or off. | | | | |

General Purpose Commands (All Function Groups)

The commands listed in this section perform general and administrative tasks. They are available in all function groups (RF Non Signalling, Audio Non Signalling).

Subsystem Options

The *Options* subsystem contains the commands for querying information on the instrument and the available options. It corresponds to the *Options* tab in the *Setup* menu opened via the *SETUP* key on the front panel.

| SYSTem:OPTions:INFO:CURRent? | | | Device Info |
|--|------------|--------------|-------------|
| Response | Def. value | Default unit | FW vers. |
| Example: Rohde&Schwarz, CMU 200-1100.0008.02,840675/018, V3.50C:SP02 2004-02-05 'RF_NSig' | – | – | V3.10 |
| Command description | | | |
| This command returns the information on the device comprising the manufacturer, model, serial number and firmware version of the current function group. This command is always a query. | | | |

Configuration File Management – System MMEMoRy

The MMEMoRy system provides mass storage capabilities for the R&S® CMU. The functionality of this system is included in the *Data* menu.

The mass storage of the CMU may be internal or external. The internal mass storage device is a section on the internal hard disk that is reserved for mass storage (directory c:\temp). The external mass storage device is either a floppy disk or a CF / PCMCIA memory card, depending on the instrument configuration. The *<msus>* (mass storage unit specifier) parameter in the MMEMoRy commands denotes the root directory of the *INTernal* or *EXTernal* mass storage device.

The *<FileName>* parameter is a string. The contents of the string may contain characters for specifying subdirectories, e.g. "\TEMP\TRASH\test.txt" for the file named *test.txt* in the *TEMP\TRASH* subdirectory of the root directory or "TEMP\TRASH\test.txt" for the file named *test.txt* in the *TEMP\TRASH* subdirectory of the current directory, to be queried with the base system command MMEMoRy:DIRectory [:CURRent] ?. The file name itself may contain the period as a separator for extensions.

| MMEMoRy:SAVE:CURRent <FileName> [,<msus>] | | | | |
|--|--|---------------|-----------|----------|
| Save configurations in current function group and test mode | | | | |
| Parameters | Parameter description | Def. value | Def. unit | FW vers. |
| "<FileName>", INTernal EXTernal | Name of the config. file to be created Storage device of the config. file | – INTernal | – – | V3.10 |
| Command description | | | | |
| This command saves the configuration of the current function group and test mode to a configuration file. A "?" in the specified file name will be replaced by current numbers that are automatically incremented, starting with zero. The auto-increment function overwrites an existing file with a "9" in its file name. For instrument settings that may be different in manual and remote control (e.g. the repetition mode for many measurements) the manual setting is saved. The command is available in all function groups. This command is R&S® CMU-specific. | | | | |

| MMEMory:RECall:CURRent <FileName> [,<msus>] | | | | |
|---|---|---------------|-----------|----------|
| Recall configurations in current function group and test mode | | | | |
| Parameters | Parameter description | Def. value | Def. unit | FW vers. |
| "<FileName>", INTernal EXTernal | Name of the config. file to be recalled Storage device of the config. file | – INTernal | – – | V3.10 |
| Command description | | | | |
| This command recalls the configuration of the current function group and test mode from a configuration file. The command is available in all function groups. This command is R&S® CMU-specific. | | | | |

Partial Reset

The *RESet* subsystem restores the (factory) default values for the current function group and test mode. It is similar to the *Reset* menu opened via the *RESET* key on the front panel.

| | |
|--|---------------|
| SYSTem:RESet:CURRent | Partial Reset |
| Command description | FW vers. |
| This command sets all parameters of the current function group and test mode to default values. The command is available in all function groups. In contrast to the <i>Reset</i> menu the command restores the default values defined for remote control operation. In cases where remote and manual control use distinct settings (e.g. the repetition mode for many measurements), the manual control settings are left unchanged. | V3.10 |

Symbolic Status Event Register Evaluation

The following commands are used to retrieve the events reported in function group *RF*; see section *Symbolic Status Event Register Evaluation* in chapter 5.

| STATus:OPERation:SYMBOLic:ENABle <Event>{,<Event>} | | Symbolic status evaluation | | |
|--|--|----------------------------|--------------|----------|
| Parameter list | Parameter description | Def. Value ⁷ | Default Unit | FW vers. |
| <Event>{,<Event>} NONE | List of symbols for events to be reported No event reported | NONE | – | V3.05 |
| Command description | | | | |
| This command enables event reporting for one or several events in the <i>RF</i> function group, i.e. it sets the corresponding bits in the <i>STATus:OPERation:CMU:SUM<nr>:CMU<nr_event>:ENABle</i> register (<nr> = 1 2, <nr_event> denotes the RF function group) and in all sum registers up to the status byte. The events and the corresponding symbols for function group <i>RF</i> are listed in Chapter 5 (see section <i>Status Registers</i>). The symbols may be entered in arbitrary order. | | | | |

⁷ The default values quoted in this command are achieved after a *STATus:PRESet* command. *RST does not supersede the entries in the status registers; see section *Reset Values of the Status Reporting Systems* in chapter 5.

| STATus:OPERation:SYMBOLic[:EVENT]? | | Symbolic status evaluation | | |
|--|---|----------------------------|--------------|----------|
| Response | Parameter description | Def. Value ⁸ | Default Unit | FW vers. |
| NONE <Event>{,<Event>} | No event in the <i>RF</i> function group List of reported events | NONE | – | V3.05 |
| Command description | | | | |
| This command is always a query. It lists the events reported in the <i>RF</i> function group and deletes these events in the <i>STATus:OPERation:CMU:SUM<nr>:CMU<nr_event>:EVENT</i> register as well as in all sum registers. | | | | |

⁸ The default values quoted in this command are achieved after a *CLS command. *RST does not supersede the entries in the status registers; see section *Reset Values of the Status Reporting Systems* in chapter 5.

RF Measurements

The commands listed in this section belong to the *RF Non Signalling* function group.

Connection Control

The remote-control commands in this section provide settings that are valid for all measurements in the *RF* function group. They correspond to the settings in the *Connection Control* popup menu (see Chapters 3 and 4).

Subsystem LEVel (Input Level)

The subsystem *LEVel* controls the level in the RF input signal path. It corresponds to the table section *Input Level* in the *Analyzer* tab of the *Connection Control* menu and to the *Analyzer Level – Reference* hotkey in the *Spectrum* menu.

| [SENSe:]LEVel:MAXimum <Level> | | | | Max. Level |
|---|------------------------------|------------|--------------|------------|
| <Level> | Parameter description | Def. value | Default unit | FW vers. |
| –40 dBm to +53 dBm | Max. input level for RF 1 | 0.0 | dBm | V1.15 |
| –54 dBm to 39 dBm | Max. input level for RF 2 | 0.0 | dBm | |
| –77 dBm to 0 dBm | Max. input level for RF 4 IN | 0.0 | dBm | |
| Command description | | | | |
| This command defines the expected maximum RF input level and sets the input measurement path accordingly. The value range depends on the used RF input and the external attenuation. If option R&S CMU-U99 (<i>RF 1 with RF 2 Level Range</i>) is fitted, RF 1 takes on the level range of RF2. | | | | |

| [SENSe:]LEVel:ATTenuation <Mode> | | | | Attenuation |
|---|---|------------|--------------|-------------|
| <Mode> | Parameter description | Def. value | Default unit | FW vers. |
| NORMal | Normal | NORMal | – | V1.15 |
| LNOise | Low noise (level at mixer 10 dB higher than in normal setting) | | | |
| LDISortion | Low distortion factor (level at mixer 10 dB lower than in normal setting) | | | |
| Command description | | | | |
| This command defines the attenuation or gain of the input measurement path. | | | | |

| [SENSe:]LEVel:MODE <Mode> | | | | Input level – Mode |
|--|--|------------|-----------|--------------------|
| <Mode> | Description of parameters | Def. value | Def. unit | FW vers. |
| MANual | Manual setting | AUT | - | |
| AUTomatic | Automatic setting corresponding to average power of signal applied | | | |
| Description of command | | | | |
| This command defines the mode for setting the maximum input level. | | | | |

| [SENSe:]LEVel:REFEreNce <Level> | | Reference Level for Spectrum | | |
|---|-----------------------------|------------------------------|--------------|----------|
| <Level> | Parameter description | Def. value | Default unit | FW vers. |
| -100 dBm to +53 dBm | Reference level for RF 1 | +30 | dBm | V1.20 |
| -100 dBm to +39 dBm | Reference level for RF 2 | +30 | | |
| -100 dBm to 0 dBm | Reference level for RF 4 IN | 0.0 | | |
| Command description | | | | |
| This command defines the reference level for <i>Spectrum</i> measurements. If option R&S CMU-U99 (<i>RF 1 with RF 2 Level Range</i>) is fitted, RF 1 takes on the level range of RF2. | | | | |

| [SENSe:]LEVel:DEFault <Enable> | | Default Settings | | |
|---|---|------------------|-----------|----------|
| <Enable> | Description of parameters | Def. value | Def. unit | FW vers. |
| ON | The parameters are set to their default values | ON | - | V1.15 |
| OFF | All or some parameters differ from the default values | | | |
| Description of command | | | | |
| If used as a setting command with the parameter <i>ON</i> this command sets all parameters of the subsystem to their default values (the setting <i>OFF</i> has no effect). | | | | |
| If used as a query the command returns whether all parameters are set to their default values (<i>ON</i>) or not (<i>OFF</i>). | | | | |

Subsystem TRIGger (Trigger Mode)

The subsystem *TRIGger* determines the trigger mode. It corresponds to the *Trigger* tab in the *Connection Control* menu and the *Analyzer Level – Trigger...* hotkeys in the measurement menus.

| TRIGger[:SEqueNce]:SOURce <Source> | | Source | | |
|---|--|------------|--------------|----------|
| <Source> | Parameter description | Def. value | Default unit | FW vers. |
| IMMediate | Free run, continuous measurement (without reference to input signal) | IMM | - | V1.15 |
| RFPower | Trigger by RF input signal level | | | |
| IFPower | (TRIG:SEQ:THR:RFP) | | | |
| EXTern | Trigger by IF signal level (TRIG:SEQ:THR:IFP) External trigger signal (fed in via connector AUX3) | | | |
| Command description | | | | |
| This command determines the source of the trigger event for the measurements. | | | | |

| TRIGger[:SEqueNce]:THReshold:RFPower <Threshold> | | Level | | |
|---|--|------------|--------------|----------|
| <Threshold> | Parameter description | Def. value | Default unit | FW vers. |
| LOW | Low trigger threshold (<i>RF Max. Level</i> – 26 dB) | MEDIum | - | V3.10 |
| MEDIum | Medium trigger threshold (<i>RF Max. Level</i> – 16 dB) | | | |
| HIGH | High trigger threshold (<i>RF Max. Level</i> – 6 dB) | | | |
| Command description | | | | |
| This command sets the RF input signal level at which the measurement is triggered relative to the maximum RF input level; see [SENSe:]LEVel:MAXimum. The setting takes effect for trigger source <i>RFPower</i> only (see TRIG:SEQ:SOUR). | | | | |

| TRIGger[:SEQuence]:THReshold:IFPower <Threshold> | | Level – IF Power | | |
|--|-----------------------|------------------|--------------|----------|
| <Threshold> | Parameter description | Def. value | Default unit | FW vers. |
| –47 dB to 0 dB | IF power threshold | –26 | dB | V3.10 |
| Command description | | | | |
| This command sets the IF signal level at which the measurement is triggered. The IF power threshold is defined relative to the maximum RF input level; see [SENSe:]LEVEl:MAXimum. The setting has effect for trigger source <i>IFPower</i> only (see TRIG:SEQ:SOUR). | | | | |

| TRIGger[:SEQuence]:SLOPe <Slope> | | Slope | | |
|--|-------------------------------|------------|--------------|----------|
| <Slope> | Parameter description | Def. value | Default unit | FW vers. |
| POSitive NEGative | Rising slope Falling slope | POS | – | V1.15 |
| Command description | | | | |
| This command qualifies whether the trigger event occurs on the <i>Rising Edge</i> or on the <i>Falling Edge</i> of the trigger signal. The setting has no influence on free run measurements (trigger source <i>IMMEDIATE</i>). | | | | |

| TRIGger[:SEQuence]:SOURce:EXTernal <Source> | | Ext. Trigger (AUX 3/4) | | |
|--|---------------------------------|------------------------|-----------|----------|
| <Source> | Description of parameters | Def. value | Def. unit | FW vers. |
| PIN6 PIN7 PIN8 | Pin for external trigger signal | PIN8 | – | V3.10 |
| Description of command | | | | |
| This command determines the pins on the AUX 3 or AUX4 connectors used for the external trigger signal. The setting only has effect if the trigger source is an <i>External</i> signal. | | | | |

| TRIGger[:SEQuence]:MTGap[?] <Trigger Gap> | | Minimum Trigger Gap | | |
|--|---|---------------------|-----------|----------|
| <Trigger Gap> | Description of parameters | Def. value | Def. unit | FW vers. |
| 1 μ s to 1000 μ s OFF | Trigger gap time (in 1 μ s steps) No trigger gap | OFF | μ s | V4.20 |
| Description of command | | | | |
| This command defines a gap time (in μ s) before a trigger event can be generated. The setting of a numeric value is effective for <i>Power</i> or <i>External</i> trigger sources. | | | | |

| TRIGger[:SEQuence]:DEFault <Enable> | | Default Settings | | |
|--|---|------------------|-----------|----------|
| <Enable> | Description of parameters | Def. value | Def. unit | FW vers. |
| ON OFF | The parameters are set to their default values All or some parameters differ from the default values | ON | – | V1.15 |
| Description of command | | | | |
| If used as a setting command with the parameter <i>ON</i> this command sets all parameters of the subsystem to their default values (the setting <i>OFF</i> has no effect). If used as a query the command returns whether all parameters are set to their default values (<i>ON</i>) or not (<i>OFF</i>). | | | | |

Subsystem RFAnalyzer... (Analyzer Settings)

The subsystem *RFAnalyzer...* sets the RF analyzer to a definite frequency and bandwidth. The settings correspond to the *Analyzer Settings* in the *Analyzer/Generator* menu.

| [SENSe]:RFAnalyzer:FREQUENCY <Frequency> | | | | Frequency |
|---|-------------------------------|------------|--------------|-----------|
| <Frequency> | Parameter description | Def. value | Default unit | FW vers. |
| 50 kHz to 2.7 GHz | Frequency (0.1 Hz resolution) | 1 GHz | Hz | V1.15 |
| Command description | | | | |
| This command defines the input frequency of the analyzer. The usable frequency range exceeds the specified range, see data sheet. | | | | |

| [SENSe]:RFAnalyzer:BANDwidth[:RESolution] <Bandwidth> | | | | Bandwidth | |
|---|--|------------|--------------|-----------|--|
| <Bandwidth> | Parameter description | Def. value | Default unit | FW vers. | |
| 10 Hz to 1 MHz WIDE | Bandwidths of the analyzer (the values are rounded in the steps 1 2 3 5) | WIDE | – | V1.15 | |
| Command description | | | | | |
| This command defines the bandwidth of the analyzer. If WIDE is set no restriction is placed on the input frequency and level. | | | | | |

Measurement Control – Subsystem RFAnalyzer

The subsystem *RFAnalyzer* controls the RF analyzer. The subsystem corresponds to the *Analyzer Power* softkey in the *Analyzer/Generator* menu.

| | | |
|--|--|----------|
| INITiate:RFAnalyzer | Start new measurement | ⇒ RUN |
| ABORT:RFAnalyzer | Abort running measurement and switch off | ⇒ OFF |
| STOP:RFAnalyzer | Stop measurement after current evaluation period | ⇒ STOP |
| CONTinue:RFAnalyzer | Next measurement step (only <i>stepping mode</i>) | ⇒ RUN |
| Command description | | FW vers. |
| These commands have no query form. They start or stop the measurement, setting it to the status indicated in the top right column. | | V1.15 |

| CONFigure:RFAnalyzer:EREPorting <Mode> | | | | Event Reporting | |
|--|---------------------------|------------|-----------|-----------------|--|
| <Mode> | Parameter description | Def. value | Def. unit | FW vers. | |
| SRQ | Service request | OFF | – | V1.15 | |
| SOPC | Single operation complete | | | | |
| SRSQ | SRQ and SRSQ | | | | |
| OFF | No reporting | | | | |
| Command description | | | | | |
| This command defines the events generated when the measurement is terminated or stopped (<i>event reporting</i> , see Chapter 5). | | | | | |

| FETCh:RFANalyzer:STATus? | | Measurement status | | |
|--|---|--------------------|-----------|----------|
| Returned value | Parameter description | Def. value | Def. unit | FW vers. |
| OFF | Measurement in the OFF state (*RST or ABORT) | OFF | – | V1.15 |
| RUN | Running (after INITiate, CONTinue or READ) | | | |
| STOP | Stopped (STOP) | | | |
| ERR | OFF (could not be started) | | | |
| STEP | Stepping mode (<stepmode>=STEP) | | | |
| RDY, | Stopped according to repetition mode and stop condition | | | |
| 1 to 10000 | Counter for current evaluation period | | | |
| NONE, | Counter not used | NONE | – | |
| Command description | | | | |
| This command is always a query. It returns the status of the measurement (see Chapters 3 and 5). | | | | |

Subsystem RFANalyzer:CONTROL

The subsystem *RFANalyzer:CONTROL* defines the statistics of the RF analyzer power measurement. The subsystem corresponds to the *Repetition* hotkey associated with the *Analyzer Power* softkey in the *Analyzer/Generator* menu.

| CONFigure:RFANalyzer:CONTROL:REPetition <Repetition> ,<StopCondition>,<Stepmode> | | | | Test cycles |
|--|---|------------|-----------|-------------|
| <Repetition> | Parameter description | Def. value | Def. unit | |
| CONTinuous | Continuous measurement (until STOP or ABORT) | SING | – | |
| SINGleshot | Single shot measurement (until Status = RDY) | | | |
| 1 to 10000 | Multiple measurement (counting, until Status = STEP RDY) | | | |
| <StopCondition> | Parameter description | Def. value | Def. unit | |
| NONE | Continue measurement even in case of error | NONE | – | |
| <Stepmode> | Description of parameters | Def. value | Def. unit | FW vers. |
| STEP | Interrupt measurement after each statistics cycle | NONE | – | V1.15 |
| NONE | Continue measurement according to its rep. mode | | | |
| Command description | | | | |
| This command determines the number of statistics cycles and the stepping mode for the measurement. A stop condition is not available. | | | | |
| Note: In the case of READ commands (READ: to) the <Repetition> parameter has no effect; the measurement is always stopped after a single shot. | | | | |

| CONFigure:RFANalyzer:POWer:RTIME <Time> | | Duration of power measurement | | |
|--|--|-------------------------------|-----------|----------|
| <Time> | Parameter description | Def. value | Def. unit | FW vers. |
| 0 to 1 | Duration of measurement. Accuracy: ± 5E-10 s | 20E-3 | s | V1.15 |
| Command description | | | | |
| This command defines the time period during which the peak power is determined. With the time 0, the power is immediately measured on the measurement start, i.e. the instantaneous value is measured. | | | | |

Results – Subsystem RFANalyzer:POWER?

The subsystem *RFANalyzer:POWER* starts the analyzer power measurement and returns the results. The subsystem corresponds to the *Analyzer Power* panel in the *Analyzer/Generator* menu.

| READ[:SCALar]:RFANalyzer:POWER? FETCh[:SCALar]:RFANalyzer:POWER? SAMPlE[:SCALar]:RFANalyzer:POWER? | | Scalar measurement results: Start single shot measurement and return results Read out measurement results (unsynchronized) Read out measurement results (synchronized) | | |
|---|--|---|--------------|----------|
| Returned value | Description | Def. value | Default unit | FW vers. |
| -120.0 dBm to +47.0 dBm | RMS power of the RF input signal (PEP) | NAN | dBm | V1.15 |
| Command description | | | | |
| These commands are always queries. They start a measurement and return the scalar measurement result. | | | | |

Subsystem RFGenerator

The subsystem *RFGenerator* configures and controls the RF generator. It corresponds to the *Generator* tab in the popup menu *Connect. Control*. The generator generates two independent RF signals Tx and Aux Tx, referenced by the third-level keywords *[:TX]* and *:AUXTx* respectively.

| DEFault:RFGenerator | | Default Settings | | |
|--|---|------------------|-----------|----------|
| <Enable> | Description of parameters | Def. value | Def. unit | FW vers. |
| ON OFF | The parameters are set to default values Some or all parameters differ from the default values | ON | – | V3.40 |
| Description of command | | | | |
| If used as a setting command with the parameter <i>ON</i> this command sets all parameters of the <i>RFGenerator</i> subsystem to default values. The setting <i>OFF</i> results in an error message. If used as a query the command returns whether all parameters are set to default values (<i>ON</i>) or not (<i>OFF</i>). | | | | |

| DEFault:RFGenerator:TX | | Default Settings | | |
|---|---|------------------|-----------|----------|
| <Enable> | Description of parameters | Def. value | Def. unit | FW vers. |
| ON OFF | The parameters are set to default values Some or all parameters differ from the default values | ON | – | V3.40 |
| Description of command | | | | |
| If used as a setting command with the parameter <i>ON</i> this command sets all parameters of the <i>RFGenerator</i> subsystem excluding the <i>RFGenerator:AUXTx</i> settings to default values. The setting <i>OFF</i> results in an error message. | | | | |
| If used as a query the command returns whether all parameters are set to default values (<i>ON</i>) or not (<i>OFF</i>). | | | | |

Subsystem RFGenerator[:TX] (TX Generator Control)

The subsystem *RFGenerator[:TX]* controls the RF generator providing the *Tx* signal. It corresponds to the *Generator Tx – Generator Control* function in the *Generator* tab of the *Connection Control* menu.

| | | |
|---|--|--------------|
| INITiate:RFGenerator[:TX] | Start RF generator, reserve resources | ⇒ <i>RUN</i> |
| ABORt:RFGenerator[:TX] | Switch off RF generator, release resources | ⇒ <i>OFF</i> |
| Command description | | FW vers. |
| These commands have no query form. They start or stop the RF generator for the Tx signal, setting it to the status indicated in the top right column. | | V1.15 |

| FEtCh:RFGenerator[:TX]:STATus? | | | | Generator status | |
|---|--|------------|-----------|------------------|--|
| Returned value | Parameter description | Def. value | Def. unit | FW vers. | |
| OFF | Generator switched off (ABORt or *RST) | OFF | – | V1.15 | |
| RUN | Running (INITiate) | | | | |
| ERR | Switched off (could not be started) | | | | |
| Command description | | | | | |
| This command is always a query. It returns the current Tx generator status. | | | | | |

Subsystem RFGenerator[:TX]... (TX Generator Settings)

The subsystem *RFGenerator[:TX]...* determines the level and frequency of the RF generator. The settings are provided in the *Generator* tab of the *Connection Control* menu.

| SOURce:RFGenerator[:TX]:LEVel <Level> | | | | RF Generator Level | |
|--|---------------------------------------|------------|-----------|--------------------|--|
| <Level> | Parameter description | Def. value | Def. unit | FW vers. | |
| –137.0 to –27.0 dBm | RF generator level at output RF1 | –27.0 | dBm | V1.15 | |
| –137.0 to –10.0 dBm | RF generator level at output RF2 | –27.0 | | | |
| –90.0 to +13.0 dBm | RF generator level at output RF 3 OUT | –27.0 | | | |
| Command description | | | | | |
| This command defines the RF generator level. The permissible value range depends on the RF output used and the external attenuation (see [SENSe:]CORRection:LOSS:OUTPut<nr>[:MAGNitude]). Moreover, in the SSB mode (see command SOURce:RFGenerator:MODulation SSB), the level ranges for all three connectors are shifted by –2 dB, and the default value for RF1 OUT is –29.0 dBm. The level ranges are also modified if the Tx and Aux Tx signals are both active and superimposed at the same connector. If option R&S CMU-U99 (RF 1 with RF 2 Level Range) is fitted, RF 1 takes on the level range of RF2. If option R&S CMU-U99 (RF 1 with RF 2 Level Range) is fitted, RF 1 takes on the level range of RF2. | | | | | |

| SOURce:RFGenerator[:TX]:FREQuency <Frequency> | | | | Frequency | |
|--|--------------------------------------|------------|-----------|-----------|--|
| <Frequency> | Parameter description | Def. value | Def. unit | FW vers. | |
| 100 kHz to 2.7 GHz | Output frequency (resolution 0.1 Hz) | 1200 MHz | Hz | V1.15 | |
| Command description | | | | | |
| This command defines the output frequency of the RF generator. The usable frequency range exceeds the specified range, see data sheet. | | | | | |

Subsystem RFGenerator:MODulation (Frequency Modulation)

The subsystem *RFGenerator:MODulation* determines the frequency modulation of the internal RF generator. It corresponds to the *Modulation* settings in the *Generator* tab of the *Connection Control* menu.

| SOURce:RFGenerator:MODulation <State> | | | | Modulation |
|--|---|------------|-----------|------------|
| <State> | Parameter description | Def. value | Def. unit | FW vers. |
| OFF | No modulation, continuous wave | OFF | – | V1.15 |
| SSB | RF output signal shifted by a constant offset frequency | | | |
| AM | Amplitude modulation | | | V2.15 |
| FM | Frequency modulation (incompatible with Aux Tx signal) | | | V3.50 |
| FMST | FM stereo transmitter (with option R&S CMU-K14) | | | V3.85 |
| Command description | | | | |
| <p>This command determines the modulation of the RF output signal. In the <i>SSB</i> mode, the frequency of the RF output signal is shifted by the frequency defined via <code>CONF:RFG:MOD:SSB:FREQ</code>. In the <i>AM</i> mode, the signal is modulated with the frequency defined via <code>CONF:RFG:MOD:SSB:FREQ</code> and with the modulation index defined via <code>CONF:RFG:MOD[:AM]:IND</code>; see below. In the <i>FM</i> mode, the RF signal has a frequency deviation defined via <code>SOURce:RFGenerator:MODulation:FM:DEVIation</code>. The frequency of the modulated signal periodically changes with the frequency defined via <code>SOURce:RFGenerator:MODulation:FM:FREQuency</code>.</p> <p>The settings for the FM stereo transmitter mode are in the <code>SOURce:RFGenerator:MODulation:FMSTereo..</code> subsystem.</p> | | | | |

| SOURce:RFGenerator:MODulation:SSB:FREQuency <Deviation> | | | | AF Frequency |
|---|---|------------|-----------|---------------|
| <Deviation> | Parameter description | Def. value | Def. unit | FW vers. |
| –300 kHz to +300 kHz | SSB frequency offset (resolution 1 kHz) | 1000 | Hz | V1.15, |
| 0 kHz to +300 kHz | AM modulation frequency | 1000 | Hz | V2.15 (AM) |
| Command description | | | | |
| <p>This command generates an AF frequency which defines either a frequency offset (if <code>SOUR:RFG:MOD</code> is set to <i>SSB</i>) or an AM modulation frequency (if <code>SOUR:RFG:MOD</code> is set to <i>AM</i>). A frequency offset can be either positive or negative; modulation frequencies must be positive.</p> | | | | |

| SOURce:RFGenerator:MODulation[:AM]:INDex <Mod_Index> | | | | Modulation Index |
|---|-----------------------|------------|-----------|-------------------------|
| <Mod_Index> | Parameter description | Def. value | Def. unit | FW vers. |
| 0 % to 100 % | Modulation index | 100 | % | V1.15, V2.15 (AM) |
| Command description | | | | |
| <p>This command defines the modulation index for AM modulation, i.e. the amplitude ration between the modulating AM signal to the RF carrier signal in percent.</p> | | | | |

| SOURce:RFGenerator:MODulation:FM:FREQUENCY <Frequency> | | | FM Frequency | |
|--|--------------------------------|------------|--------------|----------|
| <Frequency> | Parameter description | Def. value | Def. unit | FW vers. |
| 1 Hz to +50.000 kHz | FM frequency (1-Hz resolution) | 1000 | Hz | V3.50 |
| Command description | | | | |
| This command defines how fast the frequency of the FM modulated RF signal changes. | | | | |

| SOURce:RFGenerator:MODulation:FM:DEVIation <Deviation> | | | FM Deviation | |
|---|--------------------------------|------------|--------------|----------|
| <Deviation> | Parameter description | Def. value | Def. unit | FW vers. |
| 0 Hz to 500.00 kHz | FM deviation (1-Hz resolution) | 1000 | Hz | V3.50 |
| Command description | | | | |
| This command defines the frequency deviation of the FM modulated RF signal, i.e. the maximum amount by which the frequency of the modulated RF signal differs from the carrier frequency. | | | | |

Subsystem RFGenerator:MODulation:FMSTereo (Stereo Transmitter)

The following commands configure the FM stereo transmitter (option R&S CMU-K14). The stereo transmitter mode is activated via `SOURce:RFGenerator:MODulation FMST`.

| SOURce:RFGenerator:MODulation:FMSTereo:PILot:FREQUENCY? | | | Pilot Frequency | |
|---|-----------------------|------------|-----------------|----------|
| Returned value | Parameter description | Def. value | Def. unit | FW vers. |
| 19 000 Hz | Pilot frequency | 19 000 | Hz | V3.85 |
| Command description | | | | |
| This command is always a query. It returns the fixed frequency of the pilot tone. | | | | |

| SOURce:RFGenerator:MODulation:FMSTereo:PILot:DEVIation | | | Pilot Deviation | |
|---|---------------------------|------------|-----------------|----------|
| Returned value | Parameter description | Def. value | Def. unit | FW vers. |
| 0 Hz to 100 000 Hz | Pilot frequency deviation | 6 750 | Hz | V3.85 |
| Command description | | | | |
| This command specifies the frequency deviation of the pilot tone. | | | | |

| SOURce:RFGenerator:MODulation:FMSTereo:AUDio:FREQUENCY | | | Audio Frequency | |
|---|-----------------------|------------|-----------------|----------|
| Returned value | Parameter description | Def. value | Def. unit | FW vers. |
| 1 000 Hz to 100 000 Hz | Audio frequency | 1 000 | Hz | V3.85 |
| Command description | | | | |
| This command specifies the frequency of the audio tone. | | | | |

| SOURce:RFGenerator:MODulation:FMSTereo:AUDio:DEVIation | | | Audio Deviation | |
|---|---------------------------|------------|-----------------|----------|
| Returned value | Parameter description | Def. value | Def. unit | FW vers. |
| 0 Hz to 100 000 Hz | Audio frequency deviation | 67 500 | Hz | V3.85 |
| Command description | | | | |
| This command specifies the frequency deviation of the audio tone. | | | | |

| SOURce:RFGenerator:MODulation:FMSTereo:AUDio:MAPPING | | Audio Mapping | | |
|---|-----------------------|---------------|-----------|----------|
| Returned value | Parameter description | Def. value | Def. unit | FW vers. |
| MONO | Mono signal, L = R | MONO | – | V3.85 |
| LEFT | Left channel | | | |
| RIGHT | Right channel | | | |
| Command description | | | | |
| This command selects the transmission channel for the audio signal. | | | | |

Subsystem RFGenerator:FHOPping (Frequency Hopping)

The subsystem *RFGenerator:FHOPping* determines the frequency hopping of the internal RF generator. It corresponds to the *Frequency Hopping* settings in the *Generator* tab of the *Connection Control* menu.

| SOURce:RFGenerator:FHOPping:STATe <State> | | Frequency Hopping | | |
|---|---|-------------------|-----------|----------|
| <State> | Parameter description | Def. value | Def. unit | FW vers. |
| OFF | No frequency hopping | OFF | – | V1.15 |
| ON | Frequency hopping active (between the frequencies set via SOUR:RFG:FREQ and SOUR:RFG:FHOP:FREQ) | | | |
| Command description | | | | |
| This command switches the hopping output frequency of the RF generator on or off. | | | | |

| SOURce:RFGenerator:FHOPping:FREQuency <Frequency> | | Hopping Frequency | | |
|---|--|---------------------|-----------|----------|
| <Frequency> | Parameter description | Def. value | Def. unit | FW vers. |
| absolute: 100.0 kHz to 2.7 GHz | Hopping frequency (in multiples of 0.1 Hz) | 0 MHz (Hopping off) | Hz | V1.15 |
| relative: depending on normal frequency | within the rated generator frequency range | | | |
| Command description | | | | |
| This command defines the hopping output frequency of the RF generator. This alternative frequency and the frequency set via SOUR:RFG:FREQ are used for hopping. The command SOUR:RFG:FHOP:FREQ:MODE qualifies whether the value is meant to be relative to SOUR:RFG:FREQ or absolute. | | | | |

| SOURce:RFGenerator:FHOPping:FREQuency:MODE <Mode> | | Hopping Mode | | |
|---|---|--------------|-----------|----------|
| <Mode> | Parameter description | Def. value | Def. unit | FW vers. |
| ABSolute | Hopping frequency | RELative | – | V1.15 |
| RELative | Absolute with respect to the RF generator frequency | | | |
| | Relative to the RF generator frequency | | | |
| Command description | | | | |
| This command qualifies whether the frequency set using SOUR:RFG:FHOP:FREQ is meant to be relative to SOUR:RFG:FREQ or absolute. | | | | |

Subsystem RFGenerator:PULSe (Ramping)

The subsystem *RFGenerator:PULSe* determines the ramping mode of the internal RF generator. It corresponds to the *Ramping* setting in the *Generator* tab of the *Connection Control* menu.

| SOURCE:RFGenerator:PULSe:STATe <State> | | | | Ramping | |
|--|--|------------|-----------|----------|--|
| <State> | Parameter description | Def. value | Def. unit | FW vers. | |
| OFF ON | CW signal Pulsed signal with 577 μ s burst length | OFF | – | V1.15 | |
| Command description | | | | | |
| This command determines whether the RF generator generates a CW signal or a GSM-like burst signal. | | | | | |

Subsystem RFGenerator:LSMode (Low Spur Mode)

The subsystem *RFGenerator:LSMode* selects the mode to reduce the phase noise of the RF generator signal. It corresponds to the *Low Spur Mode* setting in the *Generator* tab of the *Connection Control* menu.

| SOURCE:RFGenerator:LSMode:STATe <State> | | | | Low Spur Mode | |
|---|-------------------------|------------|-----------|---------------|--|
| <State> | Parameter description | Def. value | Def. unit | FW vers. | |
| OFF ON | Low spur mode off or on | OFF | – | V3.50 | |
| Command description | | | | | |
| This command selects the mode to reduce the phase noise of the RF generator signal. | | | | | |

Subsystem RFGenerator:BANDwidth (Bandwidth)

The subsystem *RFGenerator:BANDwidth* sets the bandwidth of the modulation filter. It corresponds to the *Modulation Filter* setting in the *Generator* tab of the *Connection Control* menu.

| SOURCE:RFGenerator:BANDwidth <Bandwidth> | | | | Bandwidth | |
|--|--|------------|--------------|-----------|--|
| <Bandwidth> | Parameter description | Def. value | Default unit | FW vers. | |
| OFF F30Khz F300khz | Off (broadband) 30 kHz bandwidth 300 kHz bandwidth | F300 | – | V1.15 | |
| Command description | | | | | |
| This command defines the bandwidth of the modulation filter. | | | | | |

Subsystem RFGenerator:AUXTx... (Aux TX Signal)

The subsystem *RFGenerator:AUXTx* configures the auxiliary generator signals *Aux Tx* (only with option R&S CMU-B95 or R&S CMU-B96, *Additional RF Generator*). It corresponds to the *Generator Aux Tx* section in the *Generator* tab of the *Connection Control* menu.

The options provide an additional RF signal that can be applied to one of the RF connectors RF1 or RF2 plus an overrange signal *OLEVel* (R&S CMU-B96 only). It is possible to superimpose the RF signals at the same output connector or use different connectors (commands *OUTPut[:TX][:STATe]*, *OUTPut:AUXTx[:STATe]*, *OUTPut:AUXTx:OLEVel[:STATe]*). Moreover, it is possible to assign independent external attenuation factors to both signals (*[SENSe:]CORRection:LOSS:OUTPut<nr>...[:MAGNitude]*, *SOURce:CORRection:LOSS:OUTPut<nr>...[:MAGNitude]*).

The Aux Tx signals are generated with the modulation settings of the primary TX signal (...*RFGenerator:MODulation...*) but with no frequency hopping or ramping.

| DEFault:RFGenerator:AUXTx | | Default Settings | | |
|---|---|------------------|-----------|----------|
| <Enable> | Description of parameters | Def. value | Def. unit | FW vers. |
| ON OFF | The parameters are set to default values Some or all parameters differ from the default values | ON | – | V3.40 |
| Description of command | | | | |
| If used as a setting command with the parameter <i>ON</i> this command sets all parameters of the <i>RFGenerator:AUXTx</i> subsystem to default values. The setting <i>OFF</i> results in an error message. | | | | |
| If used as a query the command returns whether all parameters are set to default values (<i>ON</i>) or not (<i>OFF</i>). | | | | |

| INITiate:RFGenerator:AUXTx ⇒ <i>RUN</i> | | Start Aux Tx generator, reserve resources | | |
|---|--|---|--|----------|
| ABORt:RFGenerator:AUXTx ⇒ <i>OFF</i> | | Switch off generator, release resources | | |
| Command description | | | | FW vers. |
| These commands have no query form. They start or stop the RF generator for the Aux Tx signal, setting it to the status indicated in the top right column. | | | | V3.50 |

| FETCh:RFGenerator:AUXTx:STATus? | | Generator status | | |
|---|--|------------------|-----------|----------|
| Returned value | Parameter description | Def. value | Def. unit | FW vers. |
| OFF RUN ERR | Generator switched off (<i>ABORt</i> or <i>*RST</i>) Running (<i>INITiate</i>) Switched off (could not be started) | OFF | – | V3.50 |
| Command description | | | | |
| This command is always a query. It returns the current Aux Tx generator status. | | | | |

| SOURce:RFGenerator:AUXTx:PATH | | Path Selection | | |
|---|-----------------------|----------------|-----------|----------|
| Returned value | Parameter description | Def. value | Def. unit | FW vers. |
| P1 P2 | Path 1 | P1 | – | V3.80 |
| Command description | | | | |
| This command selects one of the low-level AuxTx signals configured via <i>SOURce:RFGenerator:AUXTx:...:P1</i> or <i>SOURce:RFGenerator:AUXTx:...:P2</i> . | | | | |

| SOURce:RFGenerator:AUXTx:LEVEL <Level> | | RF Level (R&S CMU-B95) | | |
|---|-----------------------------|------------------------|-----------|----------|
| <Level> | Parameter description | Def. value | Def. unit | FW vers. |
| -122 dBm to -72 dBm | Aux Tx output level at RF 1 | -72.0 | dBm | V3.40 |
| -110 dBm to -60 dBm | Aux Tx output level at RF 2 | -72.0 | dBm | |
| Command description | | | | |
| <p>This command defines the Aux Tx signal level. The resolution is 1 dB; all values entered are rounded to integer dBm steps. The value range depends on the used RF output of the CMU and the external attenuation.</p> <p>Moreover, in the SSB mode (see command <code>SOURce:RFGenerator:MODulation SSB</code>), the level ranges for all three connectors are shifted by -2 dB. The level ranges are also modified if the Tx and Aux Tx signals are both active and superimposed at the same connector. If option R&S CMU-U99 (<i>RF 1 with RF 2 Level Range</i>) is fitted, RF1 takes on the level range of RF2.</p> | | | | |

| SOURce:RFGenerator:AUXTx:LEVEL:P<nr> <Level> | | RF Level (R&S CMU-B96) | | |
|---|-----------------------------|------------------------|-----------|----------|
| <Level> | Parameter description | Def. value | Def. unit | FW vers. |
| -122 dBm to -72 dBm | Aux Tx output level at RF 1 | -72.0 | dBm | V3.80 |
| -110 dBm to -60 dBm | Aux Tx output level at RF 2 | -72.0 | dBm | |
| Command description | | | | |
| <p>This command defines the levels of the Aux Tx path 1 and path 2 (<nr> = 1, 2) signals. The level ranges and default values are identical for both paths. In contrast, the resolution for path 1 is 1 dB (all values entered are rounded to integer dBm values) whereas the resolution for path 2 is 0.1 dB.</p> <p>The level range depends on the used RF output of the CMU and the external attenuation. Moreover, in the SSB mode (see command <code>SOURce:RFGenerator:MODulation SSB</code>), the level ranges for all three connectors are shifted by -2 dB. The level ranges are also modified if the Tx and Aux Tx signals are both active and superimposed at the same connector or if option R&S CMU-U99 (<i>RF 1 with RF 2 Level Range</i>) is fitted.</p> <p>If option R&S CMU-U99 (<i>RF 1 with RF 2 Level Range</i>) is fitted, RF 1 takes on the level range of RF2.</p> | | | | |

| SOURce:RFGenerator:AUXTx:OLEVEL <Level> | | RF Level Overrange (R&S CMU-B96) | | |
|---|------------------------------------|----------------------------------|-----------|----------|
| <Level> | Parameter description | Def. value | Def. unit | FW vers. |
| -110 dBm to -28 dBm OFF | Overrange output level at RF 1 | OFF | dBm | V3.80 |
| -90 dBm to -14 dBm OFF | Overrange output level at RF 2 | OFF | dBm | |
| -70 dBm to +9 dBm OFF | Overrange output level at RF 3 OUT | OFF | | |
| Command description | | | | |
| <p>This command defines the level of the <i>Overrange</i> signal. The resolution is 1 dB (all values entered are rounded to integer dBm values). OFF switches the overrange signal off entirely.</p> <p>The level range depends on the used RF output of the CMU and the external attenuation. Moreover, in the SSB mode (see command <code>SOURce:RFGenerator:MODulation SSB</code>), the level ranges for all three connectors are shifted by -2 dB. The level ranges are also modified if the Tx and Aux Tx signals are both active and superimposed at the same connector or if option R&S CMU-U99 (<i>RF 1 with RF 2 Level Range</i>) is fitted.</p> <p>If option R&S CMU-U99 (<i>RF 1 with RF 2 Level Range</i>) is fitted, RF 1 takes on the level range of RF2.</p> | | | | |

| SOURce:RFGenerator:AUXTx:FREQUENCY <Frequency> | | Frequency (R&S CMU-B95) | | |
|---|-----------------------|-------------------------|-----------|----------|
| <Frequency> | Parameter description | Def. value | Def. unit | FW vers. |
| 350 MHz to 550 MHz 700 MHz to 1100 MHz 1400 MHz to 2200 MHz | Aux Tx frequency | 350 MHz | Hz | V3.40 |
| Command description | | | | |
| This command defines the frequency of the generated Aux Tx signal. The resolution is 200 kHz; all values entered are rounded to 200 kHz steps. If a value between the three distinct frequency bands is entered, the instrument generates an error message. | | | | |

| SOURce:RFGenerator:AUXTx:FREQUENCY:P<nr> <Frequency> | | Frequency (R&S CMU-B96) | | |
|---|---|--------------------------------|-----------|----------|
| <Frequency> | Parameter description | Def. value | Def. unit | FW vers. |
| 350 MHz to 550 MHz 700 MHz to 1100 MHz 1400 MHz to 2200 MHz | Aux Tx frequency band 1 (path 1 only) Aux Tx frequency band 2 (path 1 and 2) Aux Tx frequency band 3 (path 1 and 2) | 350 MHz (p.1) 700 MHz (p.2) | Hz | V3.80 |
| Command description | | | | |
| This command defines the frequency of the Aux Tx path 1 and path 2 (<nr> = 1, 2) signals. The resolution is 2.5 kHz; all values entered are rounded to 2.5 kHz steps. If a value between the three distinct frequency bands is entered, the instrument generates an error message. The lowest band is available for the path 1 signal only. | | | | |

Subsystem RFGenerator:GLIStmode... (Generator List Mode)

The following commands control the *Generator Listmode* (available with option R&S CMU-K47, *Smart Alignment*, only).

| DEFault:RFGenerator:GLIStmode <Enable> | | Default Settings | | |
|---|---|------------------|-----------|----------|
| <Enable> | Description of parameters | Def. value | Def. unit | FW vers. |
| ON OFF | The parameters are set to their default values Some or all parameters differ from the default values | ON | – | V4.23 |
| Description of command | | | | |
| If used as a setting command with the parameter <i>ON</i> this command sets all parameters of the subsystem to their default values (the setting <i>OFF</i> causes an error message). | | | | |
| If used as a query the command returns whether all parameters are set to their default values (<i>ON</i>) or not (<i>OFF</i>). | | | | |
| Note: This new command replaces the legacy command <code>RFGenerator:GLIStmode:DEFault</code> which remains valid for backward compatibility reasons. | | | | |

| | | | |
|---|---------------------------------|---|------------|
| INITiate:RFGenerator:GLIStmode | Start generator in list mode | ⇒ | <i>RUN</i> |
| ABORT:RFGenerator:GLIStmode | Switch off generator list mode, | ⇒ | <i>OFF</i> |
| Description of command | | | FW vers. |
| These commands have no query form. They start and stop the generator list mode, setting it to the status indicated in the top right column. | | | V4.20 |

| FETCh[:SCALar]:RFGenerator:GLISmode:STATus? | | Generator Control | | |
|--|---|-------------------|-----------|----------|
| Returns | Description of parameters | Def. value | Def. unit | FW vers. |
| OFF | Generator list mode switched off (ABORt or *RST) | OFF | – | V4.20 |
| RUN | Running (INITiate) | | | |
| STOP | Stopped | | | |
| RDY | Stopped according to repetition mode and stop condition | | | |
| STEP | Stepping mode (<stepmode>=STEP) | | | |
| ERR | Switched off (could not be started) | | | |
| Description of command | | | | |
| This command is always a query. It returns the current generator list mode status. | | | | |

| SOURce:RFGenerator:GLISmode:STEPS <Steps> | | Generator Listmode - Steps | | |
|--|---------------------------|----------------------------|-----------|----------|
| <Steps> | Description of parameters | Def. value | Def. unit | FW vers. |
| 1 to 500 | List mode steps | 50 | – | V4.20 |
| Description of command | | | | |
| This command determines number of steps in Generator list mode to be processed. Up to 500 frequency/level combinations can be defined, the number of steps limits the actual list items to be processed. | | | | |
| If this command is used as a query, it returns the current step number. | | | | |

| FETCh[:SCALar]:RFGenerator:GLISmode:EOList? | | Generator Listmode - EOL | | |
|--|---|--------------------------|-----------|----------|
| Returns | Description of parameters | Def. value | Def. unit | FW vers. |
| OFF | False, end of generator list is not reached | OFF | – | V4.20 |
| ON | True, end of list has been reached | | | |
| Description of command | | | | |
| This command is always a query. It returns the "end of generator list" flag. | | | | |

| SOURce:RFGenerator:GLISmode:DWELTime <Dwell Time> | | Dwell Time | | |
|--|--|------------|-----------|----------|
| <Dwell Time> | Description of parameters | Def. value | Def. unit | FW vers. |
| 500 µs to 1 s | Duration for each step on the defined frequency/level combination. | 0.50000 | ms | V4.20 |
| MINimum | Sets the dwell time to the minimum range value | | | |
| MAXimum | Sets the dwell time to the maximum range value | | | |
| DEFault | Sets the dwell time to the default value | | | |
| Description of command | | | | |
| If used as a setting command, the command sets the dwell time as the duration for each step on the defined frequency/level combination list item. | | | | |
| Note: The specified dwell time is constant for all list items, so in order to implement steps with longer dwell times, several list items with identical frequency and level can be repeated in the list. | | | | |

| SOURce:RFGenerator:GLISmode:FREQUENCY[500] <Frequency [1..500]> | | | | Frequency List |
|---|---|-------------|-----------|----------------|
| <Frequency [1..500]> | Description of parameters | Def. value | Def. unit | FW vers. |
| 100 kHz to +2700 MHz | Frequency list item [1] | 877.0000000 | MHz | V4.20 |
| 100 kHz to +2700 MHz | Frequency list item [2] | | | |
| ... | ... | ... | | |
| 100 kHz to +2700 MHz MINimum | Frequency list item [500] Sets the frequency to the min. range value | 926.0000000 | | |
| MAXimum | Sets the frequency to the max. range value | | | |
| DEFAULT | Sets the frequency to the default value | | | |
| Description of command | | | | |
| This command sets the frequency for each of the 500 list items, which can be in the defined RF generator range from 0.1 MHz to 2700 MHz, with an increment of 0.1 Hz. The default range is from 877.0 Mhz to 926.0 MHz, which covers the GSM900 band. | | | | |

| SOURce:RFGenerator:GLISmode:PLEVel[500] <Power Level [1..500]> | | | | Frequency List |
|---|--|------------|-----------|----------------|
| <Power Level [1..500]> | Description of parameters | Def. value | Def. unit | FW vers. |
| -137 dBm to -10 dBm | RF2 output power level list item [1] | - | dBm | V4.20 |
| -137 dBm to -10 dBm | RF2 output power level list item [2] | | | |
| ... | ... | | | |
| -137 dBm to -10 dBm MINimum | RF2 output power level list item [500] Sets the power level to the min. range value | | | |
| MAXimum | Sets the power level to the max. range value | | | |
| DEFAULT | Sets the power level to the default value | | | |
| Description of command | | | | |
| This command sets the RF2 output power level for each of the 500 list items, which can be in the defined RF generator range from -137 dBm to -10 dBm, with an increment of 0.1 dBm. The default range is is set between -28 dBm to -10 dBm. | | | | |

| SOURce:RFGenerator:GLISmode:START <Step no.> | | | | Start |
|--|----------------------------|------------|-----------|----------|
| <Step no.> | Description of parameters | Def. value | Def. unit | FW vers. |
| 1 to 500 | Start of the step sequence | 1 | - | V4.51 |
| Description of command | | | | |
| This command defines the start of the step sequence. The value must not exceed the total number of RF generator steps (SOURce:RFGenerator:GLISmode:STEPS). | | | | |

| SOURce:RFGenerator:GLISmode:SLENgth <Steps> | | | | Sequence Length |
|---|--|------------|-----------|-----------------|
| <Steps> | Description of parameters | Def. value | Def. unit | FW vers. |
| 1 to 500 OFF | Sequence length No sequence used (the generator steps through the entire step range). | OFF | - | V4.51 |
| Description of command | | | | |
| This command defines the length of the step sequence. The last step in the sequence must not be beyond the entire step range of the RF generator (SOURce:RFGenerator:GLISmode:STEPS). | | | | |

| SOURce:RFGenerator:GLISTmode:LIST <Start>, <Seq. Length>, <Start>, <Seq. Length>, <Frequency 1>, <Level 1>, <Frequency 2> ... <Level N> | | Sequence Configuration | | |
|--|--|------------------------|-----------|----------|
| <Start> | Description of parameters | Def. value | Def. unit | FW vers. |
| 1 to 500 | Start of the step sequence | 1 | – | V4.51 |
| <Seq. Length> | Description of parameters | Def. value | Def. unit | FW vers. |
| 1 to 500 OFF | Sequence length No sequence used (the generator steps through the entire step range). | OFF | – | V4.51 |
| <Frequency <n>> | Description of parameters | Def. value | Def. unit | FW vers. |
| 100 kHz to 2.7 GHz | Frequency at power step <nr> | See below | MHz | V4.51 |
| <Level <n>> | Description of parameters | Def. value | Def. unit | FW vers. |
| –137.0 dBm to –27.0 dBm –137.0 dBm to – 10.0 dBm –90.0 dBm to +13 dBm | Power at power step <nr>, output RF 1 Power at power step <nr>, output RF 2 Power at power step <nr>, RF 3 OUT | See below | dBm | V4.51 |
| Description of command | | | | |
| This command defines the step sequence with all frequencies and powers. The number N of frequency and level entries must be equal to the sequence length. | | | | |
| The default frequency and level settings are given by the default settings for the entire generator step range; see <code>SOURce:RFGenerator:GLISTmode:FREQuency<nr></code> and <code>SOURce:RFGenerator:GLISTmode:PLEVel<nr></code> . | | | | |

Subsystems INPut, OUTPut, CORRection:LOSS

The subsystems in this section contain the commands for configuration of the input and output connectors and the external attenuation factors. The subsystems correspond to the RF  tab in the popup menu *Connect. Control*.

| INPut[:STATe] <State> | | | | RF Input | |
|---|--------------------------------|------------|--------------|----------|--|
| <State> | Parameter description | Def. value | Default unit | FW vers. | |
| RF1 | Connector RF1 used as input | RF2 | – | V1.15 | |
| RF2 | Connector RF2 used as input | | | | |
| RF4 | Connector RF4 IN used as input | | | | |
| Command description | | | | | |
| This command determines the connector to be used for incoming RF signals. | | | | | |
| The bidirectional connectors RF 1 and RF 2 can be used both as input and output connectors in the same measurement (see <code>OUTPut[:STATe]</code>). Only one input and one output may be active at a time, which is why the currently active one is automatically deactivated on switchover. | | | | | |

| OUTPut[:TX][:STATe] <State> | | | | RF Output | |
|--|----------------------------------|------------|--------------|-----------|--|
| <State> | Parameter description | Def. value | Default unit | FW vers. | |
| RF1 | Connector RF1 used as output | RF2 | – | V1.15 | |
| RF2 | Connector RF2 used as output | | | | |
| RF3 | Connector RF3 OUT used as output | | | | |
| Command description | | | | | |
| This command selects the connector to be used for outgoing RF signals. The bidirectional connectors RF 1 and RF 2 can be used both as input and output connectors in the same measurement. | | | | | |

| [SENSe:]CORRection:LOSS:INPut<nr>[:MAGNitude] <Absorption> | | | | Ext. Att. Input | |
|--|----------------------------|------------|--------------|-----------------|--|
| SOURce:CORRection:LOSS:INPut<nr>[:MAGNitude] <Absorption> | | | | | |
| <Absorption> | Parameter description | Def. value | Default unit | FW vers. | |
| –50 dB to +90 dB | External input attenuation | 0.0 | dB | V1.15 | |
| Command description | | | | | |
| This commands assigns an external attenuation value to the inputs of the instrument. | | | | | |

| [SENSe:]CORRection:LOSS:OUTPut<nr>[:TX][:MAGNitude] <Absorption> | | | | Ext. Att. Output | |
|--|----------------------------|------------|--------------|------------------|--|
| SOURce:CORRection:LOSS:OUTPut<nr>[:TX][:MAGNitude] <Absorption> | | | | | |
| <Absorption> | Parameter description | Def. value | Default unit | FW vers. | |
| –50 dB to +90 dB | External input attenuation | 0.0 | dB | V1.15 | |
| Command description | | | | | |
| This command assigns an external attenuation value to the outputs of the instrument. An external attenuation of x dB increases the Tx signal level (<code>SOURce:RFGenerator[:TX]:LEVel</code>) by x dB. | | | | | |

| OUTPut:AUXTx[:STATe] <State> | | RF Output (Aux Tx) | | |
|--|------------------------------|--------------------|--------------|----------|
| <State> | Parameter description | Def. value | Default unit | FW vers. |
| RF1 | Connector RF1 used as output | RF2 | – | V3.40 |
| RF2 | Connector RF2 used as output | | | |
| Command description | | | | |
| This command determines the output connector to be used for the generated Aux Tx signal. The bidirectional connectors RF 1 and RF 2 can be used both as input and output connectors in the same measurement. | | | | |

| [SENSe:]CORRection:LOSS:OUTPut<nr>:AUXTx[:MAGNitude] <Absorption> SOURce:CORRection:LOSS:OUTPut<nr>:AUXTx[:MAGNitude] <Absorption> | | Ext. Att. Output (Aux TX) | | |
|--|---|---------------------------|--------------|----------|
| <Absorption> | Parameter description | Def. value | Default unit | FW vers. |
| –50 dB to +90 dB | Value for external attenuation at output <nr>, where <nr> = 1,2 | 0.0 | dB | V3.40 |
| Command description | | | | |
| This command assigns an external attenuation value to the outputs of the instrument. An external attenuation of x dB increases the Aux Tx signal level (SOURce:RFGenerator:AUXTx:LEVel) by x dB. | | | | |

| OUTPut:AUXTx:OLEVel[:STATe] <State> | | RF Output (Ovrange) | | |
|--|----------------------------------|---------------------|--------------|----------|
| <State> | Parameter description | Def. value | Default unit | FW vers. |
| RF1 | Connector RF1 used as output | RF2 | – | V3.80 |
| RF2 | Connector RF2 used as output | | | |
| RF3 | Connector RF3 OUT used as output | | | |
| Command description | | | | |
| This command determines the output connector to be used for the <i>Ovrange</i> signal (with option R&S CMU-B96 only). Note that while the <i>Ovrange</i> signal is at RF 1 the Tx signal (OUTPut[:TX][:STATe]) cannot be fed to RF 3 OUT and vice versa. | | | | |

| [SENSe:]CORRection:LOSS:OUTPut<nr>:AUXTx:OLEVel[:MAGNitude] <Absorption> SOURce:CORRection:LOSS:OUTPut<nr>:AUXTx:OLEVel[:MAGNitude] <Absorption> | | Ext. Att. Output (Ovrange) | | |
|---|---|----------------------------|--------------|----------|
| <Absorption> | Parameter description | Def. value | Default unit | FW vers. |
| –50 dB to +90 dB | Value for external attenuation at output <nr>, where <nr> = 1, 2, 3 | 0.0 | dB | V3.80 |
| Command description | | | | |
| This command assigns an external attenuation value to the outputs of the instrument. An external attenuation of x dB increases the Aux Tx signal level (SOURce:RFGenerator:AUXTx:OLEVel) by x dB. | | | | |

Subsystem DM:CLOCK (Synchronization)

The subsystem *DM:CLOCK* sets a system clock frequency. This frequency is set in the *Sync.* tab of the *Connect. Control* menu.

| SOURce:DM:CLOCK:STATe <Mode> | | | | REF OUT 2 |
|--|----------------------------|------------|-----------|-----------|
| <Mode> | Parameter description | Def. value | Def. unit | FW vers. |
| ON OFF | Switch system clock on/off | OFF | – | V1.15 |
| Command description | | | | |
| This command switches the system clock at the output <i>REF OUT 2</i> on or off. | | | | |

| SOURce:DM:CLOCK:FREQUency <Frequency> | | | | Clock Frequency |
|--|--|------------|-----------|-----------------|
| <Frequency> | Parameter description | Def. value | Def. unit | FW vers. |
| 1.219 MHz to 40.000 MHz | Frequency of network-specific system clock | 13 | MHz | V1.15 |
| Command description | | | | |
| This command defines the frequency at the output <i>REF OUT2</i> . In FW V2.15 ff. the frequency entered is rounded to the following discrete values: | | | | |
| 40.000 MHz, 20.000 MHz, 13.333 MHz, 10.000 MHz, 8.000 MHz, 6.667 MHz, 5.714 MHz, 5.000 MHz, 4.444 MHz, 4.000 MHz, 3.636 MHz, 3.333 MHz, 3.077 MHz, 2.857 MHz, 2.667 MHz, 2.500 MHz, 2.353 MHz, 2.222 MHz, 2.105 MHz, 2.000 MHz, 1.905 MHz, 1.818 MHz, 1.739 MHz, 1.667 MHz, 1.600 MHz, 1.538 MHz, 1.481 MHz, 1.429 MHz, 1.379 MHz, 1.333 MHz, 1.290 MHz, 1.250 MHz | | | | |
| The formula of the sequence reads as follows: | | | | |
| $f_n = f_1 \frac{1}{n} \text{ with } n = 1, 2, 3, \dots 32 \text{ and } f_1 = 40 \text{ MHz for RF}$ | | | | |
| If the entered value f is between two allowed values f_n and f_{n+1} , it is rounded to: | | | | |
| $f \rightarrow f_n \text{ if } f \geq f_1 \frac{1}{n+0.5} \text{ and } f \rightarrow f_{n+1} \text{ if } f < f_1 \frac{1}{n+0.5} .$ | | | | |

I/Q-IF Interface

The subsystem *IQIF* configures the signal paths for I/Q and IF signals provided by option CMU-B17, *I/Q and IF Interfaces*. It corresponds to the *I/Q-IF* tab of the *Connection Control* menu.

Hint: How to make sense out of parameter names

In all path configurations except bypass, both the I/Q and IF output are connected (to either the RF Unit, the Digital Unit or one of the I/Q-IF inputs). The paths differ in the connection of the input branches: The qualifier IO denotes a connected input (with connected output), XO denotes a disconnected input (with connected output). Many parameters of the IQIF commands are composed of two IO/XO qualifiers, the first one standing for the IF signal, the second for the I/Q signal.

Example: The parameter *IOXO* denotes a connected IF input and a disconnected IF output, while both output branches are connected.

For more information see the menu description and the application examples in Chapter 4.

| CONFigure:IQIF:RXTXcombined <Scenario> | | | | I/Q-IF |
|--|--|------------|-----------|----------|
| <Scenario> | Description of parameters | Def. value | Def. unit | FW vers. |
| BYP | RX/TX Bypass, RXPath = BYP, TXPath = BYP | BYP | – | V3.10 |
| BYIQ | Bypass w. I/Q-OF OUT, RXPath = TXPath =BYIQ | | | |
| XOIO | I/Q IN/OUT, RXPath = TXPath = XOIO | | | |
| IOIO | IF IN_I/Q IN/OUT, RXPath = TXPath = IOIO | | | |
| IOXO | IF IN/OUT, RXPath = TXPath = IOXO | | | |
| FPAT | Fading Path, RXPath = BYP, TXPath = XOIO | | | |
| UDEF | User-defined scenario, can not be set but may be returned by the query CONF:IQIF:RXTX? | | | |

Description of command

This command selects the I/Q-IF test scenario, overwriting the current RX and TX path settings (see commands CONFigure:IQIF:RXPath and CONFigure:IQIF:TXPath below). Six different predefined test scenarios with fixed RX and TX path are provided. Additional scenarios may be defined by selecting any other combination of RX and TX paths.

Note: UDEF is not provided as a setting parameter. If the RX/TX path combination defined via CONFigure:IQIF:RXPath and CONFigure:IQIF:TXPath doesn't correspond to any of the predefined scenarios, then a user-defined scenario is set implicitly, i.e. the query CONF:IQIF:RXTX? returns the value UDEF.

| CONFigure:IQIF:RXPath <Path> | | | | RX Path |
|------------------------------|---------------------------|------------|-----------|----------|
| <Path> | Description of parameters | Def. value | Def. unit | FW vers. |
| BYP | Bypass | BYP | – | V3.10 |
| BYIQ | Bypass w. I/Q-IF OUT | | | |
| XOIO | I/Q IN/OUT | | | |
| IOIO | IF IN_I/Q IN/OUT | | | |
| IOXO | IF IN/OUT | | | |

Description of command

This command selects the RX signal path, leaving the TX path (see command CONFigure:IQIF:TXPath below) unchanged but adapting the I/Q-IF test scenario to the new RX/TX path combination: If the combination corresponds to a predefined scenario, then CONFigure:IQIF:RXTXcombined is set to the predefined scenario; otherwise it is set to UDEF.

| CONFigure:IQIF:TXPath <Path> | | | | TX Path |
|------------------------------|---------------------------|------------|-----------|----------|
| <Path> | Description of parameters | Def. value | Def. unit | FW vers. |
| BYP | Bypass | BYP | – | V3.10 |
| BYIQ | Bypass w. I/Q-IF OUT | | | |
| XOIO | I/Q IN/OUT | | | |
| IOIO | IF IN_I/Q IN/OUT | | | |
| IOXO | IF IN/OUT | | | |

Description of command

This command selects the TX signal path, leaving the RX path (see command CONFigure:IQIF:RXPath above) unchanged but adapting the I/Q-IF test scenario to the new RX/TX path combination: If the combination corresponds to a predefined scenario, then CONFigure:IQIF:RXTXcombined is set to the predefined scenario; otherwise it is set to UDEF.

| IQIF:DEFAult <Enable> | | Default Settings | | |
|--|---|------------------|-----------|----------|
| <Enable> | Description of parameters | Def. value | Def. unit | FW vers. |
| ON | The parameters are set to their default values | ON | – | V3.10 |
| OFF | Some or all parameters differ from the default values | | | |
| Description of command | | | | |
| <p>If used as a setting command with the parameter <i>ON</i> this command sets all parameters of the subsystem to their default values (the setting <i>OFF</i> causes an error message).</p> <p>If used as a query the command returns whether all parameters are set to their default values (<i>ON</i>) or not (<i>OFF</i>).</p> | | | | |

Power Measurements (POWER)

The subsystem *POWER* measures the RF signal power versus time. The subsystem corresponds to the measurement menu *Power* and the associated popup menu *Power Configuration*.

Measurement Control – Subsystem POWER

The subsystem *POWER* controls the power measurement. The subsystem corresponds to the *Power* main softkey.

| | |
|--|--|
| INITiate:POWER | Start new measurement ⇒ <i>RUN</i> |
| ABORt:POWER | Abort running measurement and switch off ⇒ <i>OFF</i> |
| STOP:POWER ⇒ <i>STOP</i> | Stop measurement after current evaluation period |
| CONTInue:POWER ⇒ <i>RUN</i> | Next measurement step (only <i>stepping mode</i>) |
| Command description | |
| These commands have no query form. They start or stop the measurement, setting it to the status indicated in the top right column. | |
| FW vers. | |
| V1.15 | |

| CONFigure:POWER:EREPorting <Mode> | | Event reporting of the measurement | | |
|--|---------------------------|------------------------------------|-----------|----------|
| <Mode> | Parameter description | Def. value | Def. unit | FW vers. |
| SRQ | Service request | OFF | – | V1.15 |
| SOPC | Single operation complete | | | |
| SRSQ | SRQ and SOPC | | | |
| OFF | No reporting | | | |
| Command description | | | | |
| This command defines the events generated when the measurement is terminated or stopped (<i>event reporting</i> , see chapter 5). | | | | |

| FETCH:POWER:STATus? | | Measurement status | | |
|--|---|--------------------|-----------|----------|
| Returned value | Parameter description | Def. value | Def. unit | FW vers. |
| OFF | Measurement in the OFF state (*RST or ABORt) | OFF | – | V1.15 |
| RUN | Running (after INITiate, CONTInue or READ) | | | |
| STOP | Stopped (STOP) | | | |
| ERR | OFF (could not be started) | | | |
| STEP | Stepping mode (<stepmode>=STEP) | | | |
| RDY, | Stopped according to repetition mode and stop condition | | | |
| 0 to 10000 | Counter for measurement cycles | | | |
| NONE | Counter not used | NONE | – | |
| 1 to 1000 | Counter for current evaluation period within a cycle | | | |
| NONE | Statistic count set to off | NONE | – | |
| Command description | | | | |
| This command is always a query. It returns the status of the measurement (see chapters 3 and 5). | | | | |

Test Configuration

The commands in the following subsystems configure the *Power* measurement. They correspond to the *Power Configuration* popup menu.

Subsystem POWER:CONTROL (Control)

The subsystem *POWER:CONTROL* defines the scope of the *Power* measurement. The subsystem corresponds to the *Control* tab of the *Power Configuration* menu.

| CONFigure:POWER:CONTROL <Mode> | | Scope of measurement | | |
|---|--|----------------------|-----------|----------|
| <Mode> | Description of parameters | Def. value | Def. unit | |
| SCALar ARRay | Scalar values only (incl. limit matching) Scalar measured values and arrays | ARRay | – | |
| <Statistics> | Description of parameters | Def. value | Def. unit | FW vers. |
| 1 to 1000 NONE | Number of sweeps per statistics cycle Statistics off (equivalent to 1) | 1 | – | ≥1.15 |
| Description of command | | | | |
| This command specifies the type of measured values. | | | | |

| CONFigure:POWER:CONTROL:REPetition <Repetition> ,<StopCondition>,<Stepmode> | | | | |
|--|---|------------|-----------|----------|
| Measurement cycles | | | | |
| <Repetition> | Parameter description | Def. value | Def. unit | FW vers. |
| CONTInuous SINGleshot 1 to 10000 | Continuous measurement (until STOP or ABORT) Single shot measurement (until Status = RDY) Multiple measurement (counting, until Status = STEP RDY) | SING | – | – |
| <StopCondition> | Parameter description | Def. value | Def. unit | |
| NONE | Continue measurement even in case of error | NONE | – | |
| <Stepmode> | Description of parameters | Def. value | Def. unit | FW vers. |
| STEP NONE | Interrupt measurement after each statistics cycle Continue measurement according to its rep. mode | NONE | – | V1.15 |
| Command description | | | | |
| This command defines the repetition mode and the stepping mode for the measurement. A stop condition is not available. | | | | |
| Note: In the case of READ commands (READ: to) the <Repetition> parameter has no effect; the measurement is always stopped after a single shot. | | | | |

| DISPlay:POWER:CONTROL:GRID <Enable> | | | | Grid |
|---|---|----|---|-------|
| ON OFF | Switch on grid lines Switch off grid lines | ON | – | V1.15 |
| This command switches the grid lines on or off in the test diagram. | | | | |

Subsystem POWER:FREQUENCY (Frequency/RBW)

The subsystem *POWER:FREQUENCY* sets the frequency and resolution bandwidth of the *Power* measurement. The subsystem corresponds to the *Analyzer Settings* softkey in the graphical measurement menu *Power*.

| [SENSe:]POWer:FREQUency:CENTer <Frequency> | | | | Frequency |
|---|-------------------------------|------------|--------------|-----------|
| <Frequency> | Parameter description | Def. value | Default unit | FW vers. |
| 10 kHz to 2.7 GHz | Frequency (0.1 Hz resolution) | 1000 MHz | Hz | V1.15 |
| Command description | | | | |
| This command defines the input frequency of the analyzer. | | | | |

| [SENSe:]POWer:FREQUency:BANDwidth[:RESolution] <Bandwidth> | | | | RBW |
|--|---|------------|--------------|----------|
| <Bandwidth> | Parameter description | Def. value | Default unit | FW vers. |
| 10 Hz to 1 MHz | Bandwidths of power measurement (the values are rounded in the steps 1 2 3 5) | 300 kHz | – | V1.15 |
| Command description | | | | |
| This command defines the bandwidth of the power measurement. | | | | |

Subsystem POWER:LEVEl (Level)

The subsystem *POWER:LEVEl* sets the level range displayed. The subsystem corresponds to the *Level Scale* hotkey in the graphical measurement menu *Power*.

| [SENSe:]POWer:LEVEl:RANGe <Range> | | | | Range |
|---|--------------------------------------|------------|--------------|----------|
| <Range> | Parameter description | Def. value | Default unit | FW vers. |
| 10.0 dB to 100.0 dB | Level range of the power measurement | 100.0 dB | – | V1.15 |
| Command description | | | | |
| This command defines the level range of the <i>Power</i> measurement. | | | | |

Subsystem POWER:TIME

The subsystem *Power:TIME* configures the time axis. The subsystem corresponds to the *Time Scale* hotkey in the graphical measurement menu *Power*.

| [SENSe:]POWer:TIME:DELay <Delay> | | | | Delay |
|---|--|---------------|--------------|----------|
| <Delay> | Parameter description | Def. value | Default unit | FW vers. |
| See below | Delay time between trigger time and start of the measurement | -10.0 μ s | s | V1.15 |
| Command description | | | | |
| This command defines the time when the measurement is started relative to the trigger time. | | | | |
| The permissible range of delays depends on the span and bandwidth, e.g.: | | | | |
| - 152.9 μ s to 142.9 μ s (bandwidth 1 MHz, span 10 μ s) | | | | |
| - 15.7919207 s to 5.7919207 s (bandwidth 10 Hz, span 10 s) | | | | |

| [SENSe:]POWer:TIME:SPAN | | | | Span |
|---|-------------------------------|-------------|--------------|----------|
| | Parameter description | Def. value | Default unit | FW vers. |
| 10 μ s to 10 s | Span of the power measurement | 100 μ s | s | V1.15 |
| Command description | | | | |
| This command defines the span (i.e. the total evaluation time) of the <i>Power</i> measurement. The permissible spans depend on the selected bandwidth. | | | | |

| CONFigure:POWer:CONTrol:TIMEout <Timeout> | | | | |
|--|---|------------|--------------|----------|
| Timeout for triggered measurements | | | | |
| <Timeout> | Parameter description | Def. value | Default unit | FW vers. |
| 1 s to 60 s | Timeout period after which the measurement is aborted | 10 s | s | V1.15 |
| Command description | | | | |
| This command defines a timeout period after which the measurement is aborted (e.g. if no trigger event could be detected). | | | | |

Subsystem SUBarrays:POWer

The subsystem *SUBarrays:POWer* defines the measurement range and the type of output values.

| CONFigure:SUBarrays:POWer <Mode>,<Start>,<Samples>{,<Start>,<Samples>} | | Definition of Subarrays | | |
|--|--|-------------------------|-----------|----------|
| <Mode> | Description of parameters | Def. value | Def. unit | |
| ALL | Return all measurement values | ALL | – | |
| ARITHmetical | Return arithm. mean value in every subrange | | | |
| MINimum | Return minimum value in every subrange | | | |
| MAXimum | Return maximum value in every subrange | | | |
| IVAL | Return single interpolated value at <Start> | | | |
| XMAXimum | Return x-axis value of maximum and maximum | | | |
| XMINimum | Return x-axis value of minimum and minimum | | | |
| PAVG , | Return arithmetic mean value in every subrange | | | |
| <Start> | Description of parameters | Def. value | Def. unit | |
| –15 s to 15 s, | Start time in current range | Min | s | |
| <Samples> | Description of parameters | Def. value | Def. unit | FW vers. |
| 1 to 500 | Number of samples in current subrange | Max | – | 3.0 |
| Description of command | | | | |
| <p>This command configures the <code>READ:SUBarrays:POWer...</code>, <code>FETCh:SUBarrays:POWer...</code>, and <code>SAMPlE:SUBarrays:POWer</code> commands. It restricts the measurement to up to 32 subranges where either all measurement results (the number of which is given by the second numerical parameter) or a single statistical value is returned. The subranges are defined by the start time and the number of test points to be measured.</p> <p>For <Mode> = IVAL, the <Samples> parameter is ignored and the CMU returns a single measurement value corresponding to the abscissa value <Start>. If <Start> is located between two test points with valid results then the result is calculated from the results at these two adjacent test points by linear interpolation.</p> <p>The subranges may overlap but must be within the total range of the <code>POWer</code> measurement defined via <code>[SENSe:]POWer:TIME:DELAy</code> and <code>[SENSe:]POWer:TIME:SPAN</code>. Test points outside this range are not measured (result <i>NAN</i>) and do not enter into the <code>ARITHmetical</code>, <code>MINimum</code> and <code>MAXimum</code> values.</p> <p>By default, only one range corresponding to the total measurement range is used and all measurement values are returned.</p> | | | | |

Results – Subsystem POWER...?

The subsystem *POWER...?* starts the power measurement and returns the results. The subsystem corresponds to the graphical measurement menu *Power*.

| | | | | |
|---|-----------------------------------|------------|--------------|----------|
| READ:ARRay:POWer[:CURRent]? | | | | |
| Power Results | | | | |
| READ:ARRay:POWer:AVERage? | | | | |
| READ:ARRay:POWer:MAXimum? | | | | |
| READ:ARRay:POWer:MINimum? | | | | |
| ⇒ RUN | | | | |
| FETCh:ARRay:POWer[:CURRent]? | | | | |
| FETCh:ARRay:POWer:AVERage? | | | | |
| FETCh:ARRay:POWer:MAXimum? | | | | |
| FETCh:ARRay:POWer:MINimum? | | | | |
| ⇒ RUN | | | | |
| SAMPle:ARRay:POWer[:CURRent]? | | | | |
| SAMPle:ARRay:POWer:AVERage? | | | | |
| SAMPle:ARRay:POWer:MAXimum? | | | | |
| SAMPle:ARRay:POWer:MINimum? | | | | |
| ⇒ RUN | | | | |
| Returned value | Parameter description | Def. value | Default unit | FW vers. |
| -128.0 dBm to + 48.0 dBm, | 1 st value for power | NAN | dBm | V 1.15 |
| ... | | | | |
| -128.0 dBm to + 48.0 dBm | 500 th value for power | NAN | dBm | |
| Command description | | | | |
| These commands are always queries. They return the power values versus time at 1000 equidistant test points. The measurement range is defined via [SENSE:]POWER:TIME:DELay and [SENSE:]POWER:TIME:SPAN. | | | | |
| Note: The number of test points may be reduced at very narrow measurement ranges. | | | | |

```

READ:SUBarrays:POWer[:CURRent]?
    Subarray Results
READ:SUBarrays:POWer:AVERage?
READ:SUBarrays:POWer:MAXimum?
READ:SUBarrays:POWer:MINimum?
    ⇒ RUN
    Start single shot meas. and return results

FETCh:SUBarrays:POWer[:CURRent]?
FETCh:SUBarrays:POWer:AVERage?
FETCh:SUBarrays:POWer:MAXimum?
FETCh:SUBarrays:POWer:MINimum?
    ⇒ RUN
    Read meas. results (unsynchronized)

SAMPlE:SUBarrays:POWer[:CURRent]?
SAMPlE:SUBarrays:POWer:AVERage?
SAMPlE:SUBarrays:POWer:MAXimum?
SAMPlE:SUBarrays:POWer:MINimum?
    ⇒ RUN
    Read results (synchronized)
    
```

| Ret. values by subrange | Description of parameters | Def. value | Def. unit | FW vers. |
|--------------------------|---|------------|-----------|----------|
| -128.0 dBm to + 48.0 dBm | Power[1], 1 st value for power | NAN | dBm | V3.0 |
| ... | ... | ... | ... | |
| -128.0 dBm to + 48.0 dBm | Power[x], xth value for power | NAN | dBm | |

Description of command

These commands are always queries. They return the power versus time in the subranges defined by means of the **CONFigure:SUBarrays:POWer** command. In the default setting of the configuration command the **READ:SUBarrays...**, **FETCh:SUBarrays...**, and **SAMPlE:SUBarrays...** command group is equivalent to the **READ:ARRay...**, **FETCh:ARRay...**, and **SAMPlE:ARRay...** command group described above.

The **CONFigure:SUBarrays:POWer** command defines a maximum of 32 subranges. If one of the statistical modes (**ARITHmetical**, **MINimum**, **MAXimum**, **PAVG**) or **IVAL** is set, only one value is returned per subrange. For **XMAXimum** and **XMINimum**, two values per subrange are returned.

Spectrum Measurements (SPECTrum)

The subsystem *SPECTrum* measures the RF frequency spectrum. The subsystem corresponds to the measurement menu *Spectrum* and the associated popup menu *Spectrum Configuration*.

Measurement Control – Subsystem SPECTrum

The subsystem *SPECTrum* controls the spectrum measurement. It corresponds to the *Spectrum*. softkey in the measurement menu *Spectrum*.

| | |
|--|--|
| INITiate:SPECTrum ⇒ <i>RUN</i> | Start new measurement |
| ABORt:SPECTrum ⇒ <i>OFF</i> | Abort running measurement and switch off |
| STOP:SPECTrum ⇒ <i>STOP</i> | Stop measurement after current evaluation period |
| CONTInue:SPECTrum ⇒ <i>RUN</i> | Next measurement step (only <i>stepping mode</i>) |
| Command description | |
| These commands have no query form. They start or stop the measurement, setting it to the status indicated in the top right column. | |
| FW vers. | |
| V1.15 | |

| CONFigure:SPECTrum:EREPorting <Mode> | | | Event Reporting | |
|--|---------------------------|------------|-----------------|----------|
| <Mode> | Parameter description | Def. value | Def. unit | FW vers. |
| SRQ | Service request | OFF | – | V1.15 |
| SOPC | Single operation complete | | | |
| SRSQ | SRQ and SOPC | | | |
| OFF | No reporting | | | |
| Command description | | | | |
| This command defines the events generated when the measurement is terminated or stopped (<i>event reporting</i> , see chapter 5). | | | | |

| FETCh:SPECTrum:STATus? | | Measurement status | | |
|--|---|--------------------|-----------|----------|
| Returned value | Parameter description | Def. value | Def. unit | FW vers. |
| OFF | Measurement in the <i>OFF</i> state (*RST or ABORT) | OFF | – | V1.15 |
| RUN | Running (after INITiate, CONTinue or READ) | | | |
| STOP | Stopped (STOP) | | | |
| ERR | OFF (could not be started) | | | |
| STEP | Stepping mode (<stepmode>=STEP) | | | |
| RDY, | Stopped according to repetition mode and stop condition | | | |
| 0 to 10000 | Counter for measurement cycles | | | |
| NONE | Counter not used | NONE | – | |
| 1 to 1000 | Counter for current evaluation period within a cycle | | | |
| NONE | Statistic count set to off | NONE | – | |
| Command description | | | | |
| This command is always a query. It returns the status of the measurement (see chapters 3 and 5). | | | | |

| [SENSe:]SPECTrum:DETEctor <Mode> | | Detect Mode | | |
|---|---|-------------|-----------|----------|
| <Mode> | Description of parameters | Def. value | Def. unit | FW vers. |
| PEAK | Meas. curve interpolated from maximum values | PEAK | – | V3.05 |
| RMS | Meas. curve interpolated from RMS averaged values | | | |
| Description of command | | | | |
| This command defines how the measurement curve is calculated from the entire set of measurement points. | | | | |

Test Configuration

The commands in the following subsystems configure the *Spectrum* measurement. They correspond to the *Spectrum Configuration* popup menu.

Subsystem SPECTrum:CONTrol

The subsystem *SPECTrum:CONTrol* defines the scope of the spectrum measurement. It corresponds to the tab *Control* in the popup menu *Spectrum Configuration*.

| CONFIgure:SPECTrum:CONTrol <Mode>, <Statistics> | | Scope of measurement | | |
|---|---|----------------------|-----------|----------|
| <Mode> | Description of parameters | Def. value | Def. unit | |
| SCALar | Scalar values only (incl. limit matching) | ARRay | – | |
| ARRay | Scalar measured values and arrays | | | |
| <Statistics> | Description of parameters | Def. value | Def. unit | FW vers. |
| 1 to 1000 | Number of sweeps per statistics cycle | 1 | – | ≥1.15 |
| NONE | Statistics off (equivalent to 1) | | | |
| Description of command | | | | |
| This command specifies the type of measured values and defines the number of sweeps forming a statistics cycle. | | | | |

| CONFigure:SPECTrum:CONTRol:REPetition <Repetition> ,<StopCondition>,<Stepmode> | | | | |
|--|---|------------|-----------|----------|
| Measurement cycles | | | | |
| <Repetition> | Parameter description | Def. value | Def. unit | |
| CONTinuous SINGleshot 1 to 10000 | Continuous measurement (until STOP or ABORT) Single shot measurement (until Status = RDY) Multiple measurement (counting, until Status = STEP RDY) | SING | – | |
| <StopCondition> | Parameter description | Def. value | Def. unit | |
| NONE | Continue measurement in case of error | NONE | – | |
| <Stepmode> | Description of parameters | Def. value | Def. unit | FW vers. |
| STEP NONE | Interrupt measurement after each statistics cycle Continue measurement according to its rep. mode | NONE | – | V1.15 |
| Command description | | | | |
| This command defines the repetition mode and the stepping mode for the measurement. A stop condition is not available. | | | | |
| Note: In the case of READ commands (READ: to) the <Repetition> parameter has no effect; the measurement is always stopped after a single shot. | | | | |
| DISPlay:SPECTrum:CONTRol:GRID <Enable> | | | | |
| Grid | | | | |
| ON OFF | Switch on grid lines Switch off grid lines | ON | – | V1.15 |
| This command switches the grid lines on or off in the test diagram. | | | | |

Subsystem SPECTrum:FREQuency (Frequency/RBW)

The subsystem *SPECTrum:FREQuency* defines the display range of the frequency axis and the resolution bandwidth. The subsystem corresponds to the *Analyzer Settings* softkey in the graphical measurement menu *Spectrum*.

| [SENSe:]SPECTrum:FREQuency:CENTer <Frequency> | | | | |
|---|-----------------------|------------|--------------|----------|
| Center / Span / Start | | | | |
| [SENSe:]SPECTrum:FREQuency:SPAN <Frequency> | | | | |
| [SENSe:]SPECTrum:FREQuency:START <Frequency> | | | | |
| [SENSe:]SPECTrum:FREQuency:STOP <Frequency> | | | | |
| <Frequency> | Parameter description | Def. value | Default unit | FW vers. |
| 10.0 MHz to 2.7 GHz | Center frequency | 1105 | MHz | V1.15 |
| 0.00001 MHz to 2.690 GHz | Frequency span | 2190 | MHz | |
| 10 MHz to 2.7 GHz | Start frequency | 10 | MHz | |
| 10.00001 MHz to 2.7 GHz | Stop frequency | 2200 | MHz | |
| Command description | | | | |
| This command sets the center frequency and span or the start and stop frequency of the spectrum analyzer. Start and stop frequency are used for calculation of the other two frequencies. | | | | |

| [SENSe:]SPEctrum:FREquency:BAWdwidth[:RESolution] <Bandwidth> | | | | RBW |
|---|---|------------|--------------|----------|
| [SENSe:]SPEctrum:FREquency:BWIDth[:RESolution] <Bandwidth> | | | | |
| <Bandwidth> | Parameter description | Def. value | Default unit | FW vers. |
| 10 Hz to 1 MHz AUTO | Bandwidths of measurement (the values are rounded in the steps 1 2 3 5) | AUTO | – | V1.15 |
| Command description | | | | |
| This command defines the bandwidth of the spectrum measurement. The range of the bandwidth is shifted and increased along with the span of the measurement. | | | | |

Subsystem SPEctrum:LEVel (Level)

The subsystem *POWER:LEVel* sets the level range of the *Spectrum* measurement. The subsystem corresponds to the *Level Scale* hotkey in the graphical measurement menu *Spectrum*.

| [SENSe:]SPEctrum:LEVel:RANGe <Range> | | | | Range |
|--|---|------------|--------------|----------|
| <Range> | Parameter description | Def. value | Default unit | FW vers. |
| 10.0 dB to 100.0 dB | Level range for the spectrum measurement. | 100.0 dB | – | V1.15 |
| Command description | | | | |
| This command defines the level range for the spectrum measurement. | | | | |

Subsystem SUBarrays:SPECTrum



The subsystem *SUBarrays:SPECTrum* defines the measurement range and the type of output values.

| CONFigure:SUBarrays:SPECTrum <Mode>,<Start>,<Samples>{,<Start>,<Samples>} | | Definition of Subarrays | | |
|---|--|-------------------------|-----------|----------|
| <Mode> | Description of parameters | Def. value | Def. unit | |
| ALL | Return all measurement values | ALL | – | |
| ARITHmetical | Return arithm. mean value in every subrange | | | |
| MINimum | Return minimum value in every subrange | | | |
| MAXimum | Return maximum value in every subrange | | | |
| IVAL | Return single interpolated value at <Start> | | | |
| XMAXimum | Return x-axis value of maximum and maximum | | | |
| XMINimum | Return x-axis value of minimum and minimum | | | |
| PAVG , | Return arithmetic mean value in every subrange | | | |
| <Start> | Description of parameters | Def. value | Def. unit | |
| 10 MHz to 2.69999999 GHz, | Start frequency in current range | Min | Hz | |
| <Samples> | Description of parameters | Def. value | Def. unit | FW vers. |
| 1 to 560 | Number of samples in current subrange | Max | – | 3.0 |
| Description of command | | | | |
| <p>This command configures the <code>READ:SUBarrays:SPECTrum...</code>, <code>FETCh:SUBarrays:SPECTrum...</code>, and <code>SAMPlE:SUBarrays:SPECTrum</code> commands. It restricts the measurement to up to 32 subranges where either all measurement results (the number of which is given by the second numerical parameter) or a single statistical value is returned. The subranges are defined by the start frequency and the number of test points to be measured.</p> <p>For <Mode> = IVAL, the <Samples> parameter is ignored and the CMU returns a single measurement value corresponding to the abscissa value <Start>. If <Start> is located between two test points with valid results then the result is calculated from the results at these two adjacent test points by linear interpolation.</p> <p>The subranges may overlap but must be within the total range of the SPECTrum measurement defined by the commands <code>[SENSe:]SPECTrum:FREQUency:CENTer</code> and <code>[SENSe:]SPECTrum:FREQUency:SPAN</code> or by <code>[SENSe:]SPECTrum:FREQUency:STARt</code> and <code>[SENSe:]SPECTrum:FREQUency:STOP</code>. Test points outside this range are not measured (result <i>NAN</i>) and do not enter into the ARITHmetical, MINimum and MAXimum values.</p> <p>By default, only one range corresponding to the total measurement range is used and all measurement values are returned.</p> | | | | |

SPECTrum Markers

The commands in the *SPECTrum:MARKer* subsystem query trace values and perform a peak search.

| FETCh:SPECTrum:MARKer:ABSolute? <x position> | | | Reference Marker Value | |
|---|-------------------------------|------------|------------------------|----------|
| <x position> | Parameter description | Def. value | Default unit | |
| <Start Frequency> to <Stop Frequency> ¹⁾ | Frequency of reference marker | – | Hz | |
| Response | Parameter description | Def. value | Default unit | FW vers. |
| –128.0 dBm to +48 dBm | Reference marker level | NAN | dBm | V3.53 |
| Command description | | | | |
| This command sets a virtual reference marker to the specified <x position> and returns the measured RF level at this position. The command doesn't affect the reference marker  in manual control. | | | | |
| 1) The frequency range for the <i>Spectrum</i> measurement is set via [SENSe:]SPECTrum:FREQuency:START and [SENSe:]SPECTrum:FREQuency:STOP. | | | | |

| FETCh:SPECTrum:MARKer:RELative? <x1 position>, <x2 position> | | | Relative (Delta) Marker Values | |
|--|----------------------------------|------------|--------------------------------|----------|
| <x1 position> | Parameter description | Def. value | Default unit | |
| <Start Frequency> to <Stop Frequency> ¹⁾ | Frequency of delta marker 1 | – | Hz | |
| <x2 position> | Parameter description | Def. value | Default unit | |
| <Start Frequency> to <Stop Frequency> ¹⁾ | Frequency of delta marker 2 | – | Hz | |
| Response | Parameter description | Def. value | Default unit | FW vers. |
| –128.0 dBm to +48 dBm | Difference between marker levels | NAN | dBm | V3.53 |
| Command description | | | | |
| This command sets virtual delta markers 1 and 2 to the specified x-positions and returns the difference of the two marker levels <i>level (marker 1) – level (marker 2)</i> . The command doesn't affect the relative (delta) markers  and  in manual control. | | | | |
| 1) The frequency range for the <i>Spectrum</i> measurement is set via [SENSe:]SPECTrum:FREQuency:START and [SENSe:]SPECTrum:FREQuency:STOP. | | | | |

| FETCh:SPECTrum:MARKer:PEAK? | | | Peak Search | |
|---|---|-------------|--------------|----------|
| Response | Parameter description | Def. value | Default unit | FW vers. |
| <Start Frequency> to <Stop Frequency> ¹⁾ , –128.0 dBm to +48 dBm | Frequency at the peak Peak level of the spectrum trace | NAN, NAN | Hz dBm | V3.53 |
| Command description | | | | |
| This command places the reference marker to the maximum of the trace and returns the marker frequency and the peak level. NAN, NAN is returned if no <i>Spectrum</i> measurement is running. The command also affects the reference marker  in manual control. | | | | |
| 1) The frequency range for the <i>Spectrum</i> measurement is set via [SENSe:]SPECTrum:FREQuency:START and [SENSe:]SPECTrum:FREQuency:STOP. | | | | |

Results – Subsystem SPECTrum

The subsystem *SPECTrum* starts the *Spectrum* measurement and returns the results. The subsystem corresponds to the various output elements in the graphical measurement menu *Spectrum*.

| READ:ARRay:SPECTrum[:CURRent]? Spectrum Results READ:ARRay:SPECTrum:AVERAge? READ:ARRay:SPECTrum:MAXimum? READ:ARRay:SPECTrum:MINimum? | | | | | Start single shot meas. and return results |
|---|-------------------------------|------------|--------------|----------|--|
| ⇒ RUN | | | | | |
| FETCh:ARRay:SPECTrum[:CURRent]? FETCh:ARRay:SPECTrum:AVERAge? FETCh:ARRay:SPECTrum:MAXimum? FETCh:ARRay:SPECTrum:MINimum? | | | | | Read meas. results (unsynchronized) |
| ⇒ RUN | | | | | |
| SAMPlE:ARRay:SPECTrum[:CURRent]? SAMPlE:ARRay:SPECTrum:AVERAge? SAMPlE:ARRay:SPECTrum:MAXimum? SAMPlE:ARRay:SPECTrum:MINimum? | | | | | Read results (synchronized) |
| ⇒ RUN | | | | | |
| Returned value | Parameter description | Def. value | Default unit | FW vers. | |
| -128.0 dBm to + 48.0 dBm | 1 st power value | NAN | dBm | V1.15 | |
| ... | | | | | |
| -128.0 dBm to + 48.0 dBm | 560 th power value | NAN | dBm | | |
| Command description | | | | | |
| These commands are always queries. They return the results of the spectrum measurement at 560 equidistant test points. The measurement range is defined by the commands [SENSE:]SPECTrum:FREQuency:CENTer and [SENSE:]SPECTrum:FREQuency: SPAN or by [SENSE:]SPECTrum:FREQuency:STArt and [SENSE:]SPECTrum: FREQuency:STOP. | | | | | |
| Note: The number of test points may be reduced at very narrow measurement ranges. | | | | | |

```

READ:SUBarrays:SPECTrum[:CURRent]?
    Subarray Results
READ:SUBarrays:SPECTrum:AVERAge?
READ:SUBarrays:SPECTrum:MAXimum?
READ:SUBarrays:SPECTrum:MINimum?
    ⇒ RUN
    Start single shot meas. and return results

FETCh:SUBarrays:SPECTrum[:CURRent]?
FETCh:SUBarrays:SPECTrum:AVERAge?
FETCh:SUBarrays:SPECTrum:MAXimum?
FETCh:SUBarrays:SPECTrum:MINimum?
    ⇒ RUN
    Read meas. results (unsynchronized)

SAMPlE:SUBarrays:SPECTrum[:CURRent]?
SAMPlE:SUBarrays:SPECTrum:AVERAge?
SAMPlE:SUBarrays:SPECTrum:MAXimum?
SAMPlE:SUBarrays:SPECTrum:MINimum?
    ⇒ RUN
    Read results (synchronized)
    
```

| Ret. values by subrange | Description of parameters | Def. value | Def. unit | FW vers. |
|--------------------------|---|------------|-----------|----------|
| -128.0 dBm to + 48.0 dBm | Power[1], 1 st value for power | NAN | dBm | 3.0 |
| ... | ... | ... | ... | |
| -128.0 dBm to + 48.0 dBm | Power[x], xth value for power | NAN | dBm | |

Description of command

These commands are always queries. They return the power versus frequency in the subranges defined by means of the `CONFigure:SUBarrays:SPECTrum` command. In the default setting of the configuration command the `READ:SUBarrays...`, `FETCh:SUBarrays...`, and `SAMPlE:SUBarrays...` command group is equivalent to the `READ:ARRay...`, `FETCh:ARRay...`, and `SAMPlE:ARRay...` command group described above.

The `CONFigure:SUBarrays:SPECTrum` command defines a maximum of 32 subranges. If one of the statistical modes (`ARITHmetical`, `MINimum`, `MAXimum`, `PAVG`) or `IVAL` is set, only one value is returned per subrange. For `XMAXimum` and `XMINimum`, two values per subrange are returned.

The calculation of `CURRent`, `AVERAge`, `MINimum`, and `MAXimum` results is explained in Chapter 3 (see *Display Mode*).

WPOWER

The subsystem *WPOWER* measures the power of the signal transmitted by the mobile phone over a wide frequency range. It corresponds to the softkey *Pow. Meter Wideband* in the *RF* connector tab of the *Connect. Control* menu.

| | |
|--|--|
| INITiate:WPOWER ⇒ <i>RUN</i> | Start new measurement |
| ABORT:WPOWER ⇒ <i>OFF</i> | Abort measurement and switch off |
| STOP:WPOWER ⇒ <i>STOP</i> | Stop measurement |
| CONTInue:WPOWER ⇒ <i>RUN</i> | Next measurement step (only <i>counting mode</i>) |
| Description of command | |
| These commands have no query form. They start or stop the measurement, setting it to the status given in the top right column. | |
| FW vers. | |
| V3.10 | |

| CONFigure:WPOWER:EREPorting <Mode> | | Event Reporting | | |
|--|---------------------------|-----------------|-----------|----------|
| <Mode> | Description of parameters | Def. value | Def. unit | FW vers. |
| SRQ | Service request | OFF | – | V3.10 |
| SOPC | Single operation complete | | | |
| SRSQ | SRQ and SOPC | | | |
| OFF | No reporting | | | |
| Description of command | | | | |
| This command defines the events generated when the measurement is terminated or stopped (<i>event reporting</i> , see Chapter 5). | | | | |

| FETCH:WPOWER:STATUs? | | Measurement | | |
|--|---|-------------|-----------|----------|
| <i>Return</i> | Description of parameters | Def. value | Def. unit | FW vers. |
| OFF | Measurement in the <i>OFF</i> state (*RST or ABORT) | OFF | – | V3.10 |
| RUN | Running (after <i>INITiate</i> , <i>CONTInue</i> or <i>READ</i>) | | | |
| STOP | Stopped (<i>STOP</i>) | | | |
| ERR | <i>OFF</i> (could not be started) | | | |
| STEP | Stepping mode (< <i>stepmode</i> >= <i>STEP</i>) | | | |
| RDY, | Stopped according to repetition mode and stop condition | | | |
| 1 ... 10000 | Counter for current statistics cycle | | | |
| NONE | No counting mode set | NONE | – | |
| Description of command | | | | |
| This command is always a query. It returns the status of the measurement (see chapters 3 and 5 of CMU operating manual). | | | | |

| CONFigure:WPOWer:CONTRol:REPetition <Repetition>,<StopCond>,<Stepmode> | | | | Test cycles |
|---|---|------------|-----------|-------------|
| <Repetition> | Description of parameters | Def. value | Def. unit | |
| CONTinuous SINGleshot 1 ... 10000 | Continuous measurement (until STOP or ABORT) Single shot measurement (until Status = RDY) Multiple measurement (counting, until Status = STEP RDY) | SING | – | |
| <StopCond> | Description of parameters | Def. value | Def. unit | |
| SONerror NONE | Start measurement in case of error (stop on error) Continue measurement even in case of error | NONE | – | |
| <Stepmode> | Description of parameters | Def. value | Def. unit | FW vers. |
| STEP NONE | Interrupt measurement after each statistics cycle Continue measurement according to its rep. mode | NONE | – | V3.10 |
| Description of command | | | | |
| This command determines the number of statistics cycles, the stop condition and the stepping mode for the measurement. | | | | |
| Note: In the case of READ commands (READ: ...), the <Repetition> parameter has no effect; the measurement is always stopped after a single shot. | | | | |

Measured Values – Subsystem WPOWer?

The subsystem WPOWer? retrieves the results of the wideband power measurement.

| READ[:SCALar]:WPOWer? Start single shot measurement and return results | | | | |
|---|-----------------------------|------------|-----------|----------|
| FETCh[:SCALar]:WPOWer? Read out measurement results (unsynchronized) | | | | |
| SAMPlE[:SCALar]:WPOWer? Read out measurement results (synchronized) | | | | |
| Return | Description of parameters | Def. value | Def. unit | FW vers. |
| 0 dBm to +55 dBm | Maximum RF power at RF1 | NAN | dBm | V3.10 |
| –10 dBm to +35 dBm | Maximum RF power at RF2 | | | |
| –35 dBm to +2 dBm | Maximum RF power at RF 4 IN | | | |
| Description of command | | | | |
| These commands are always queries. They start the measurement of the maximum RF power (peak power, not averaged) and return the result. If option R&S CMU-U99 (RF 1 with RF 2 Level Range) is fitted, RF 1 takes on the level range of RF2. | | | | |

NPOWER (Function Group RF)

The subsystem *NPOWER* measures the power of an RF signal using a narrow-band filter with variable bandwidth. Gaussian filters with bandwidths between 10 Hz and 1 MHz are available. In addition, the measurement can be performed with the root-raised cosine filter specified in standard TIA/EIA-136.xxx or with an 1.4 MHz bandpass filter specified for CDMA measurements.

The *NPOWER* measurement is performed at the frequency set via `[SENSe:]RFANalyzer:FREQuency`. The filter bandwidth (*RBW*) is set via `[SENSe:]NPOWER:BWIDth[:RESolution]`; it does not depend on the RBW defined for the *POWER* and *SPECTrum* measurement.

The CMU measures the average, maximum and minimum power of the RF signal in a basic evaluation period comprising a fixed number of samples (4096). In addition to these *Current* values the minimum and maximum power in the entire measurement and the average of the average current values, referenced to a statistics cycle, is calculated (see section [Measured Values – Subsystem NPOWER?](#) on p. 6.82 ff.). The measurement time depends on the filter bandwidth but never exceeds the order of magnitude of 100 ms for a single evaluation period. The frequency of the RF signal is also measured, provided that is close enough to the measurement frequency set via `[SENSe:]POWER:FREQuency:CENTer`. The characteristics of the *NPOWER* measurement makes it particularly suitable for the analysis of CW signals where no measurement curves are needed. Compared to the *Analyzer Power* measurement (subsystem `RFANalyzer`), it provides a wider range of filters, additional statistical evaluations and an additional frequency counter.

Note: *The configuration of the RF input path (`[SENSe:]LEVel:MAXimum`, `[SENSe:]LEVel:MODE`) and the trigger settings (`TRIGger[:SEQuence]:SOURce`, `TRIGger[:SEQuence]:THReshold`) can have an effect on the *NPOWER* measurement.*

| | | |
|--|--|----------|
| INITiate:NPOWER | Start new measurement | ⇒ RUN |
| ABORT:NPOWER | Abort measurement and switch off | ⇒ OFF |
| STOP:NPOWER | Stop measurement | ⇒ STOP |
| CONTinue:NPOWER | Next measurement step (only <i>counting mode</i>) | ⇒ RUN |
| Description of command | | FW vers. |
| These commands have no query form. They start or stop the measurement, setting it to the status given in the top right column. | | V3.07 |

| CONFigure:NPOWER:EREPorting <Mode> | | | Event Reporting | | |
|--|---------------------------|------------|-----------------|----------|--|
| <Mode> | Description of parameters | Def. value | Def. unit | FW vers. | |
| SRQ | Service request | OFF | – | V3.07 | |
| SOPC | Single operation complete | | | | |
| SRSQ | SRQ and SOPC | | | | |
| OFF | No reporting | | | | |
| Description of command | | | | | |
| This command defines the events generated when the measurement is terminated or stopped (<i>event reporting</i> , see Chapter 5). | | | | | |

| FETCh:NPOWer:STATus? | | Measurement Status | | |
|---|--|--------------------|-----------|----------|
| Return | Description of parameters | Def. value | Def. unit | FW vers. |
| OFF RUN STOP ERR STEP RDY, | Measurement in the OFF state (*RST or ABORT) Running (after INITiate, CONTinue or READ) Stopped (STOP) OFF (could not be started) Stepping mode (<stepmode>=STEP) Stopped according to repetition mode and stop condition | OFF | – | V3.07 |
| 1 to 10000 NONE | Counter for current statistics cycle No counting mode set | NONE | – | |
| 1 to 1000 NONE | Counter for current evaluation period within a cycle Statistic count set to off | NONE | – | |
| Description of command | | | | |
| This command is always a query. It returns the status of the measurement (see Chapter 3 and Chapter 5). | | | | |

Subsystem NPOWer:CONTRol

The subsystem *NPOWer:CONTRol* defines the repetition mode, statistic count, stop condition, and stepping mode of the *NPOWer* measurement.

| CONFIgure:NPOWer:CONTRol <Statistics>, <Repetition>, <StopCond>, <Stepmode> | | Scope of Measurement | | |
|---|---|----------------------|-----------|----------|
| <Statistics> | Description of parameters | Def. value | Def. unit | |
| 1 to 1000 NONE | No. of evaluation periods within a statistics cycle Statistics off | 1 | – | |
| <Repetition> | Description of parameters | Def. value | Def. unit | |
| CONTInuous SINGleshot 1 ... 10000 | Continuous measurement (until STOP or ABORT) Single shot measurement (until Status = RDY) Multiple measurement (counting, until Status = STEP RDY) | SING | – | |
| <StopCond> | Description of parameters | Def. value | Def. unit | |
| SONerror NONE | Start measurement in case of error (stop on error) Continue measurement even in case of error | NONE | – | – |
| <Stepmode> | Description of parameters | Def. value | Def. unit | FW vers. |
| STEP NONE | Interrupt measurement after each statistics cycle Continue measurement according to its rep. mode | NONE | – | V3.07 |
| Description of command | | | | |
| This command defines the statistic count, repetition mode, stop condition, and stepping mode for the measurement. | | | | |

| CONFigure:NPOWER:CONTROL:STATistics <Statistics> | | | | Statistic Count |
|--|---|------------|-----------|-----------------|
| <Statistics> | Description of parameters | Def. value | Def. unit | FW vers. |
| 1 to 1000 NONE | No. of evaluation periods within a statistics cycle Statistics off | 1 | – | V3.07 |
| Description of command | | | | |
| This command defines the number of evaluation periods that represent one statistics cycle. | | | | |

| CONFigure:NPOWER:CONTROL:REPetition <Repetition>, <StopCond>, <Stepmode> | | | | Test cycles |
|--|--|------------|-----------|-------------|
| <Repetition> | Description of parameters | Def. value | Def. unit | |
| CONTinuous SINGleshot 1 ... 10000 | Continuous measurement (until STOP or ABORT) Single shot measurement (until Status = RDY) Multiple measurement (counting, until Status = STEP RDY) | SING | – | |
| <StopCond> | Description of parameters | Def. value | Def. unit | |
| SONerror NONE | Start measurement in case of error (stop on error) Continue measurement even in case of error | NONE | – | – |
| <Stepmode> | Description of parameters | Def. value | Def. unit | FW vers. |
| STEP NONE | Interrupt measurement after each statistics cycle Continue measurement according to its rep. mode | NONE | – | V3.07 |
| Description of command | | | | |
| This command determines the repetition mode, the stop condition and the stepping mode for the measurement. | | | | |
| Note: In the case of READ commands (READ:...), the <Repetition> parameter has no effect; the measurement is always stopped after a single shot. | | | | |

Subsystem NPOWER:FREQuency (RBW)

The subsystem NPOWER:FREQuency sets the filter bandwidth of the narrow-band power measurement.

| [SENSe:]NPOWER:BWIDth[:RESolution] <Bandwidth> | | | | RBW |
|--|--|------------|--------------|----------|
| <Bandwidth> | Parameter description | Def. value | Default unit | FW vers. |
| 10 Hz to 1 MHz TDMA CDMA | Bandwidths of power measurement (the values are rounded in 1 2 3 5 steps) TDMA or CDMA filter | 300 kHz | – | V3.07 |
| Command description | | | | |
| This command defines the bandwidth of the power measurement. The TDMA filter is a matched (root-raised cosine) filter specified in standard TIA/EIA-136xxx for the test of modulation parameters. The CDMA filter is a 1.4 MHz bandpass filter specified for cdmaOne and CDMA2000 tests. | | | | |

Measured Values – Subsystem NPOWer?

The subsystem *NPOWer?* retrieves the results of the narrow-band power measurement (see general information on p. 6.79).

| READ[:SCALar]:NPOWer? | Start single shot measurement and return results | | | |
|--|--|------------|-----------|----------|
| FETCh[:SCALar]:NPOWer? | Read out measurement results (unsynchronized) | | | |
| SAMPlE[:SCALar]:NPOWer? | Read out measurement results (synchronized) | | | |
| Returned values | Value range | Def. value | Def. unit | FW vers. |
| Avg. Power of Current evaluation period, | -137 dBm to +53 dBm | NAN | dBm | V3.07 |
| Min. Power of Current evaluation period, | -137 dBm to +53 dBm | NAN | dBm | |
| Max. Power of Current evaluation period, | -137 dBm to +53 dBm | NAN | dBm | |
| Avg. Power ref. to the last stat. cycle, | -137 dBm to +53 dBm | NAN | dBm | |
| Min. Power of the entire measurement, | -137 dBm to +53 dBm | NAN | dBm | |
| Max. Power of the entire measurement | -137 dBm to +53 dBm | NAN | dBm | |
| Frequency | 10 kHz to 2.7 GHz | NAN | Hz | |
| Description of command | | | | |
| These commands are always queries. They start the <i>NPOWer</i> measurement and return the results. As the CMU is capable of determining frequencies with an accuracy of 0.1 Hz, the frequency is returned in exponential representation and with a 10-digit mantissa. | | | | |

I/Q Recorder

The *I/Q Recorder* (*IQRecorder*) provides the I/Q data that the R&S CMU200/300 acquires with different IF filter settings. After the measurement is started, the instrument records a predefined number of samples (`CONFigure:IQRecorder:CONTrol:CLEngth`). The measurement can be started explicitly (`INITiate:IQRecorder`, with *Free Run* trigger) or by an appropriate trigger source (power trigger, external trigger). The trigger settings are described on p. 6.32 ff. of the R&S CMU200/300 operating manual. A measurement-specific trigger delay can be added; see `CONFigure:IQRecorder:CONTrol:TDElay`.

Measurement results are retrieved by means of the `READ:IQRecorder...`, `FETCh:IQRecorder...`, `SAMPlE:IQRecorder...` commands. The application provides different (complex or polar) output formats; see `CONFigure:IQRecorder:RMODE`. Moreover it is possible to obtain the results as comma-separated ASCII arrays or in binary format (keywords `ARRay` or `BINary`). Binary data transfer offers several advantages:

- The transfer is faster and more efficient (the size of the output strings is typically reduced by a factor of 3 to 4).
- Binary data can be directly post-processed by many external applications without previous conversion

On the other hand, the transfer of ASCII arrays can be refined by means of subarray commands.

The *I/Q Recorder* (*IQRecorder*) is a remote control application which is located in the *RF* function group. There is no equivalent measurement menu in manual control.

The performance of the application is improved with option R&S CMU-U65, *Measurement DSP for WCDMA*; see overview below.

Table 6-2 I/Q Recorder performance with option R&S CMU-U65

| | No option | R&S CMU-U65V02 | R&S CMU-U65V04 |
|--|---------------------|---------------------|----------------------|
| IF Bandwidth (see Table 6-3 on p. 6.83) | 50 kHz to 1 MHz | 50 kHz to 1 MHz | 50 kHz to 5 MHz |
| Sampling Rate (see Table 6-3 on p. 6.83) | 200 kHz to 4000 kHz | 200 kHz to 4000 kHz | 200 kHz to 10000 kHz |
| Max. Capture Length | 32768 samples | 65536 samples | 65536 samples |
| Max. Trigger Delay | ±32000 samples | ±64000 samples | ±64000 samples |

Measurement Control

The following commands control the measurement.

| | | |
|---|--|---------------|
| INITiate:IQRecorder | Start new measurement | ⇒ <i>RUN</i> |
| ABORt:IQRecorder | Abort running measurement and switch off | ⇒ <i>OFF</i> |
| STOP:IQRecorder | Stop measurement after current stat. cycle | ⇒ <i>STOP</i> |
| Description of command | | FW vers. |
| These commands have no query form. They start and stop the measurement, setting it to the status indicated in the top right column. | | V3.80 |

| CONFigure:IQRecorder:EREPorting <Mode> | | Event Reporting | | |
|--|---------------------------|-----------------|-----------|----------|
| <Mode> | Description of parameters | Def. value | Def. unit | FW vers. |
| SRQ | Service request | OFF | – | V3.80 |
| SOPC | Single operation complete | | | |
| SRSQ | SRQ and SOPC | | | |
| OFF | No reporting | | | |
| Description of command | | | | |
| This command defines the events generated when the measurement is terminated or stopped (<i>event reporting</i> , see Chapter 5 of the operating manual). | | | | |

| FETCh:IQRecorder:STATus? | | Measurement Status | | |
|--|---|--------------------|-----------|----------|
| Ret. values | Description of parameters | Def. value | Def. unit | FW vers. |
| OFF | Measurement in the <i>OFF</i> state (*RST or ABORt) | OFF | – | V3.80 |
| RUN | Running (after INITiate or READ) | | | |
| STOP | Stopped (STOP) | | | |
| ERR | <i>OFF</i> (could not be started) | | | |
| RDY, | Stopped according to repetition mode and stop condition | | | |
| NONE | No statistical mode set | NONE | – | |
| Description of command | | | | |
| This command is always a query. It returns the status of the measurement (see Chapters 3 and 5 of the operating manual). | | | | |

| FETCh:IQRecorder:FSBW? | | | Filter Characteristics | |
|---|---------------------------|------------|------------------------|----------|
| Ret. values | Description of parameters | Def. value | Def. unit | FW vers. |
| NYQ GAUS, 400 000 Hz to 10 000 000 Hz, 50 000 Hz to 5 000 000 Hz | Filter type | NYQ | – | V3.80 |
| | Sampling rate | 2 000 000 | Hz | |
| | Filter bandwidth | 1 000 000 | Hz | |
| Description of command | | | | |
| This commands are always queries. They return the status of the measurement (see Chapters 3 and 5 of the operating manual). | | | | |

Table 6-3 I/Q recorder filter types, bandwidths, and filter types

| Filter Type | Bandwidth / kHz | Sampling Rate / kHz | Required Option |
|------------------------------------|------------------------|---------------------|-----------------------------------|
| Gauss | 50 | 400 | No option, CMU-U65V02, CMU-U65V04 |
| | 100 | 800 | No option, CMU-U65V02, CMU-U65V04 |
| | 200 | 2000 | No option, CMU-U65V02, CMU-U65V04 |
| | 300 | 4000 | No option, CMU-U65V02, CMU-U65V04 |
| | 500 | 4000 | No option, CMU-U65V02, CMU-U65V04 |
| | 1000 | 4000 | No option, CMU-U65V02, CMU-U65V04 |
| Nyquist (roll off = 0.5) | 50 | 200 | No option, CMU-U65V02, CMU-U65V04 |
| | 100 | 400 | No option, CMU-U65V02, CMU-U65V04 |
| | 200 | 1000 | No option, CMU-U65V02, CMU-U65V04 |
| | 285.714 (setting: 300) | 2000 | No option, CMU-U65V02, CMU-U65V04 |
| | 500 | 2000 | No option, CMU-U65V02, CMU-U65V04 |
| | 1000 | 2000 | No option, CMU-U65V02, CMU-U65V04 |
| | 2000 | 4000 | No option, CMU-U65V02, CMU-U65V04 |
| | 3000 | 10000 | CMU-U65V04 |
| | 5000 | 10000 | CMU-U65V04 |

Test Configuration

The following commands configure the *I/Q Recorder* measurement.

| CONFigure:IQRecorder:CONTrol:FILTer <Type> | | | Filter | |
|--|---------------------------|------------|-----------|----------|
| <Type> | Description of parameters | Def. value | Def. unit | FW vers. |
| GAUS NYQ | Gauss filter | NYQ | – | V3.80 |
| | Nyquist filter | | | |
| Description of command | | | | |
| This command specifies the IF filter type. | | | | |

| CONFigure:IQRecorder:CONTRol:GFILTer <Bandwidth> | | | | Filter |
|---|--|------------|-----------|----------|
| <Bandwidth> | Description of parameters | Def. value | Def. unit | FW vers. |
| F50k F100K F200K F300K F500K F1M | 50 kHz, 100 kHz, 200 kHz, 300 kHz, 500 kHz, 1 MHz, | F1M | – | V3.80 |
| Description of command | | | | |
| This command specifies the filter bandwidth for IF filters of Gaussian type (CONFigure:IQRecorder:CONTRol:FILTer GAUS). | | | | |

| CONFigure:IQRecorder:CONTRol:NFILTer <Bandwidth> | | | | Filter |
|--|--|------------|-----------|----------|
| <Bandwidth> | Description of parameters | Def. value | Def. unit | FW vers. |
| F50k F100K F200K F300K F500K F1M F2M F3M F4M | 50 kHz, 100 kHz, 200 kHz, 300 kHz, 500 kHz, 1 MHz, 3 MHz, 5 MHz (with option CMU-U65V04) | F1M | – | V3.80 |
| Description of command | | | | |
| This command specifies the filter bandwidth for IF filters of Nyquist type (CONFigure:IQRecorder:CONTRol:FILTer NYQ). The 3-MHz and 5-MHz bandwidths correspond to highest sampling rates and require option CMU-U65V04; see Table 6-3 on p. 6.83. The F300K setting actually corresponds to a bandwidth of 285.714 kHz. | | | | |

| CONFigure:IQRecorder:CONTRol:TDELaY <Delay> | | | | Trigger Delay |
|--|---|------------|-----------|---------------|
| <Delay> | Description of parameters | Def. value | Def. unit | FW vers. |
| –32000 samples to +32000 samples –64000 samples to +64000 samples | Trigger delay without option Trigger delay with option R&S CMU-U65V02 or CMU-U65V04 | 0 | (samples) | V3.80 |
| Description of command | | | | |
| This command specifies a number of sample periods between the trigger event and the start of the measurement. The resulting trigger delay time depends on the filter settings; see Table 6-3 on p. 6.83. The samples are continuously acquired and stored so that negative trigger delays are allowed. | | | | |

| CONFigure:IQRecorder:CONTRol:CTIMEout <Timeout> | | | | Capture Timeout |
|---|---|------------|-----------|-----------------|
| <Timeout> | Description of parameters | Def. value | Def. unit | FW vers. |
| 1 s/10 to 600 s/10 OFF | Capture timeout (in multiples of 0.1 s) No timeout checked | 10 | 1/10 s | V3.80 |
| Description of command | | | | |
| This command specifies a maximum time between the start of the measurement and the trigger time in tenths of a second (numeric entry: 1 to 600). The setting is valid for power and external trigger events. If no trigger occurs, the READ...:ARRAy:... commands return NTR. | | | | |

| CONFigure:IQRecorder:CONTRol:CLENgth <Samples> | | | | Capture Length |
|--|--|------------|-----------|----------------|
| <Samples> | Description of parameters | Def. value | Def. unit | FW vers. |
| 1 sample to +32768 samples 1 sample to +65536 samples | Capture length without option Capture length with option R&S CMU- U65V02 or CMU-U65V04 | 1024 | (samples) | V3.80 |
| Description of command | | | | |
| This command specifies the number of samples acquired in every single measurement. | | | | |

| CONFigure:IQRecorder:CONTRol:RMODe <Format> | | | | Format |
|---|--|------------|-----------|----------|
| <Format> | Description of parameters | Def. value | Def. unit | FW vers. |
| IQ | Rectangular values (I and Q amplitudes) | PLW | – | V3.80 |
| PLW | Polar values (magnitude and wrapped phase) | | | |
| PLUW | Polar values (magnitude and unwrapped phase) | | | |
| Description of command | | | | |
| <p>This command specifies the output format for the I/Q data. Rectangular values can be retrieved by means of the commands READ...:ARRay:IQRecorder:I?, READ...:ARRay:IQRecorder:Q? etc. Polar values can be retrieved by means of READ...:ARRay:IQRecorder:PHASe?, READ...:ARRay:IQRecorder:LEVel?, READ...:ARRay:IQRecorder:PL? etc. Polar and rectangular representation of the results are equivalent:</p> $\begin{aligned} \langle \text{Magnitude} \rangle &= \sqrt{\langle I \rangle^2 + \langle Q \rangle^2}; & \langle \text{Phase} \rangle &= \arctan (\langle Q \rangle / \langle I \rangle) \\ \langle I \rangle &= \langle \text{Magnitude} \rangle * \cos (\langle \text{Phase} \rangle) & \langle Q \rangle &= \langle \text{Magnitude} \rangle * \sin (\langle \text{Phase} \rangle) \end{aligned}$ <p>Wrapped phase means that the phase is limited to values between –180° and +180°.</p> | | | | |

| CONFigure:IQRecorder:CONTRol:LFOFormat <Unit> | | | | Unit |
|--|---------------------------------|------------|-----------|----------|
| <Unit> | Description of parameters | Def. value | Def. unit | FW vers. |
| VOLT DBM | Linear or logarithmic magnitude | DBM | – | V3.80 |
| Description of command | | | | |
| <p>This command specifies the unit for the magnitude if one of the polar formats is active (CONFigure:IQRecorder:CONTRol:RMODe PLW PLUW). Volts and dBm values are converted assuming a reference impedance of 50 Ω.</p> <p>For the rectangular (I/Q) format, the unit is always V, and negative values are allowed.</p> | | | | |

| DEFault:IQRecorder:CONTRol <Enable> | | | | Default Settings |
|---|---|------------|-----------|------------------|
| <Enable> | Description of parameters | Def. value | Def. unit | FW vers. |
| ON | The parameters are set to default values | ON | – | V3.80 |
| OFF | Some or all parameters differ from the default values | | | |
| Description of command | | | | |
| <p>If used as a setting command with the parameter ON this command sets all parameters of the subsystem to default values (the setting OFF results in an error message). If used as a query the command returns whether all parameters are set to default values (ON) or not (OFF).</p> | | | | |

Subarray Configuration

The subsystem *SUBarrays:POWER:SLOT* defines the measurement range and the type of output values.

| CONFigure:SUBarrays:IQRecorder <Mode>,<Start>,<Samples>{,<Start>,<Samples>} | | | | |
|---|--|------------|-----------|----------|
| Definition of Subarrays | | | | |
| <Mode> | Description of parameters | Def. value | Def. unit | |
| ALL | Return all measurement values | ALL | – | |
| ARITHmetical | Return arithm. mean value in every range | | | |
| MINimum | Return minimum value in every range | | | |
| MAXimum | Return maximum value in every range | | | |
| IVAL, | Return single value at <Start> | | | |
| <Start> | Description of parameters | Def. value | Def. unit | |
| 1 to N, | First sample in current range | 1 | – | |
| <Samples> | Description of parameters | Def. value | Def. unit | FW vers. |
| 1 to N | Number of samples in current range | N | – | V3.80 |
| Description of command | | | | |
| <p>This command configures the <code>READ:SUBarrays:IQRecorder...</code>, <code>FETCh:SUBarrays:IQRecorder...</code>, and <code>SAMPlE:SUBarrays:IQRecorder...</code> commands. It restricts the measurement to up to 32 subranges where either all measurement results (the number of which is given by the second numerical parameter) or a single statistical value is returned. The subranges are defined by the current number of the first sample and the number of samples within a subrange.</p> <p>The subranges may overlap but must be within the range of the <i>I/Q Recorder</i> measurement which is defined by the capture length N (<code>CONFigure:IQRecorder:CONTrol:CLEngth</code>). Results outside this range are not available (result <i>NAN</i>) and do not enter into the <i>ARITHmetical</i>, <i>MINimum</i> and <i>MAXimum</i> values.</p> <p>By default, only one range corresponding to the total measurement range is used and all measurement values are returned.</p> | | | | |
|  <p><i>Subarrays are only available for data transfer in ASCII format.</i></p> | | | | |

ASCII Results – Subsystem IQRecorder:ARRay

The subsystem *IQRecorder:ARRay...?* measures and returns the *I/Q Recorder* results as a comma-separated array of ASCII values.

| | | Phase values | | |
|--|--|--|-----------|----------|
| READ:ARRay:IQRecorder:PHASE? | | Start single shot measurement and return results | | |
| FETCh:ARRay:IQRecorder:PHASE? | | Read out meas. results (unsynchronized) | | |
| SAMPlE:ARRay:IQRecorder:PHASE? | | Read out measurement results (synchronized) | | |
| Returned values | Description of parameters | Def. value | Def. unit | FW vers. |
| OK NTR OFLW INV, | Measurement status indicators | INV | – | V3.80 |
| 1 N, | Number of values | NAN | – | |
| –180 deg to +180 deg, | 1 st value for phase (status = OK only) | NAN | deg | |
| ..., | ... | NAN | deg | |
| –180 deg to +180 deg | N th value for phase (status = OK only) | NAN | deg | |
| Description of command | | | | |
| <p>These commands are always queries. They start a <i>IQRecorder</i> measurement (<i>READ...</i>) and/or return the phases. A polar format (<i>CONFigure:IQRecorder:CONTRol:RMODe PLW PLUW</i>) must be active to obtain valid results. In the unwrapped phase format (<i>PLUW</i>), the phase is not restricted to the range between –180 deg and +180 deg.</p> <p>N denotes the total number of samples acquired (capture length, <i>CONFigure:IQRecorder:CONTRol:CLENgth</i>). The status indicators have the following meaning:</p> <p><i>OK</i> Valid measurement data. The output array contains N phase values (<i>OK, N, phase₁, ..., phase_N</i>).</p> <p><i>NTR</i> No trigger event received during the <i>capture timeout</i> (<i>CONFigure:IQRecorder:CONTRol:CTIMEout</i>). The output array reads (<i>NTR, 1 NAN</i>).</p> <p><i>OFLW</i> Overflow, input path overdriven. The output array reads (<i>OFLW, 1 NAN</i>).</p> <p><i>INV</i> Invalid measurement data (e.g. because the wrong format was selected). The output array reads (<i>INV, 1 NAN</i>).</p> | | | | |

| | | Magnitude values | | |
|--|--|--|-----------|----------|
| READ:ARRay:IQRecorder:LEVel? | | Start single shot measurement and return results | | |
| FETCh:ARRay:IQRecorder:LEVel? | | Read out meas. results (unsynchronized) | | |
| SAMPlE:ARRay:IQRecorder:LEVel? | | Read out measurement results (synchronized) | | |
| Returned values | Description of parameters | Def. value | Def. unit | FW vers. |
| OK NTR OFLW INV, | Measurement status indicators | INV | – | V3.80 |
| 1 N, | Number of values | NAN | – | |
| –100 dBm to +60 dBm, | 1 st value for magnitude (status = OK only) | NAN | dBm | |
| ..., | ... | NAN | dBm | |
| –100 dBm to +60 dBm | N th value for magnitude (status = OK only) | NAN | dBm | |
| Description of command | | | | |
| <p>These commands are always queries. They start a <i>IQRecorder</i> measurement (<i>READ...</i>) and/or return the magnitudes. A polar format (<i>CONFigure:IQRecorder:CONTRol:RMODe PLW PLUW</i>) must be active to obtain valid results. If the magnitude is expressed as an equivalent voltage, the output values are approx. in the range $2.2 \cdot 10^{-6}$ V to 220 V.</p> <p>N denotes the total number of samples acquired (capture length, <i>CONFigure:IQRecorder:CONTRol:CLENgth</i>). The status indicators are described on p. 6.88.</p> | | | | |

| | | Phase and magnitude values | | |
|---|--|--|-----------|----------|
| READ:ARRay:IQRecorder:PL? | | Start single shot measurement and return results | | |
| FETCh:ARRay:IQRecorder:PL? | | Read out meas. results (unsynchronized) | | |
| SAMPlE:ARRay:IQRecorder:PL? | | Read out measurement results (synchronized) | | |
| Returned values | Description of parameters | Def. value | Def. unit | FW vers. |
| OK NTR OFLW INV, 1 N, -180 deg to +180 deg, -100 dBm to +60 dBm, ... -180 deg to +180 deg, -100 dBm to +60 dBm | Measurement status indicators | INV | – | V3.80 |
| | Number of values | NAN | – | |
| | 1 st value for phase (status = OK only) | NAN | deg | |
| | 1 st value for magnitude (status = OK only) | NAN | dBm | |
| | ... | NAN | | |
| | N th value for phase (status = OK only) | NAN | deg | |
| N th value for magnitude (status = OK only) | NAN | dBm | | |
| Description of command | | | | |
| These commands are always queries. They start a IQRecorder measurement (READ. . .) and/or return the phases and magnitudes. A polar format (CONFIgure:IQRecorder:CONTRol:RMODe PLW PLUW) must be active to obtain valid results. In the unwrapped phase format (PLUW), the phase is not restricted to the range between -180 deg and +180 deg. If the magnitude is expressed as an equivalent voltage, the output values are approx. in the range $2.2 \cdot 10^{-6}$ V to 220 V. | | | | |
| N denotes the total number of samples acquired (capture length, CONFIgure:IQRecorder:CONTRol:CLENgth). The status indicators are described on p. 6.88. | | | | |

| | | I amplitudes | | |
|---|--|--|-----------|----------|
| READ:ARRay:IQRecorder:I? | | Start single shot measurement and return results | | |
| FETCh:ARRay:IQRecorder:I? | | Read out meas. results (unsynchronized) | | |
| SAMPlE:ARRay:IQRecorder:I? | | Read out measurement results (synchronized) | | |
| Returned values | Description of parameters | Def. value | Def. unit | FW vers. |
| OK NTR OFLW INV, 1 N, -220 V to +220 V, ... -220 V to +220 V | Measurement status indicators | INV | – | V3.80 |
| | Number of values | NAN | – | |
| | 1 st value for I amplitude (status = OK only) | NAN | V | |
| | ... | NAN | V | |
| | N th value for I amplitude (status = OK only) | NAN | V | |
| Description of command | | | | |
| These commands are always queries. They start a IQRecorder measurement (READ. . .) and/or return the I amplitudes. The rectangular format (CONFIgure:IQRecorder:CONTRol:RMODe IQ) must be active to obtain valid results. | | | | |
| N denotes the total number of samples acquired (capture length, CONFIgure:IQRecorder:CONTRol:CLENgth). The status indicators are described on p. 6.88. | | | | |

| | | Q amplitudes | | |
|--|--|--|-----------|----------|
| READ:ARRAY:IQRecorder:Q? | | Start single shot measurement and return results | | |
| FETCh:ARRAY:IQRecorder:Q? | | Read out meas. results (unsynchronized) | | |
| SAMPlE:ARRAY:IQRecorder:Q? | | Read out measurement results (synchronized) | | |
| Returned values | Description of parameters | Def. value | Def. unit | FW vers. |
| OK NTR OFLW INV, 1 N, -220 V to +220 V, ... -220 V to +220 V | Measurement status indicators | INV | – | V3.80 |
| | Number of values | NAN | – | |
| | 1 st value for Q amplitude (status = OK only) | NAN | V | |
| | ... | NAN | V | |
| | N th value for Q amplitude (status = OK only) | NAN | V | |
| Description of command | | | | |
| <p>These commands are always queries. They start a <code>IQRecorder</code> measurement (<code>READ...</code>) and/or return the Q amplitudes. The rectangular format (<code>CONFigure:IQRecorder:CONTRol:RMoDe IQ</code>) must be active to obtain valid results.</p> <p>N denotes the total number of samples acquired (capture length, <code>CONFigure:IQRecorder:CONTRol:CLENgth</code>). The status indicators are described on p. 6.88.</p> | | | | |

| | | I and Q amplitudes | | |
|--|--|--|-----------|----------|
| READ:ARRAY:IQRecorder:IQ? | | Start single shot measurement and return results | | |
| FETCh:ARRAY:IQRecorder:IQ? | | Read out meas. results (unsynchronized) | | |
| SAMPlE:ARRAY:IQRecorder:IQ? | | Read out measurement results (synchronized) | | |
| Returned values | Description of parameters | Def. value | Def. unit | FW vers. |
| OK NTR OFLW INV, 1 N, -220 V to +220 V, -220 V to +220 V, ... -220 V to +220 V -220 V to +220 V | Measurement status indicators | INV | – | V3.80 |
| | Number of values | NAN | – | |
| | 1 st value for I amplitude (status = OK only) | NAN | V | |
| | 1 st value for Q amplitude (status = OK only) | NAN | V | |
| | ... | NAN | V | |
| | N th value for I amplitude (status = OK only) | NAN | V | |
| N th value for Q amplitude (status = OK only) | NAN | V | | |
| Description of command | | | | |
| <p>These commands are always queries. They start a <code>IQRecorder</code> measurement (<code>READ...</code>) and/or return the I and Q amplitudes. The rectangular format (<code>CONFigure:IQRecorder:CONTRol:RMoDe IQ</code>) must be active to obtain valid results.</p> <p>N denotes the total number of samples acquired (capture length, <code>CONFigure:IQRecorder:CONTRol:CLENgth</code>). The status indicators are described on p. 6.88.</p> | | | | |

Measured Subarrays – Subsystem IQRecorder:SUBArray

The subsystem *IQRecorder:SUBArray...?* measures and returns the *I/Q Recorder* subarray results.

| | | Phase values | | |
|--|--|--|-----------|----------|
| READ:SUBArrays:IQRecorder:PHASe? | | Start single shot measurement and return results | | |
| FETCh:SUBArrays:IQRecorder:PHASe? | | Read out meas. results (unsynchronized) | | |
| SAMPlE:SUBArrays:IQRecorder:PHASe? | | Read out measurement results (synchronized) | | |
| Returned values | Description of parameters | Def. value | Def. unit | FW vers. |
| OK NTR OFLW INV, | Measurement status indicators | INV | – | V3.80 |
| 1 N, | Number of values | NAN | – | |
| –180 deg to +180 deg, | 1 st value for phase (status = OK only) | NAN | deg | |
| ... | ... | NAN | deg | |
| –180 deg to +180 deg | N th value for phase (status = OK only) | NAN | deg | |
| Description of command | | | | |
| <p>These commands are always queries. They start a <i>IQRecorder</i> measurement (<i>READ...</i>) and/or return the phases in the subranges defined by means of the <i>CONFigure:SUBArrays:IQRecorder</i> command (see p. 6.86). A polar format (<i>CONFigure:IQRecorder:CONTRol:RMODe PLW PLUW</i>) must be active to obtain valid results. In the unwrapped phase format (<i>PLUW</i>), the phase is not restricted to the range between –180 deg and +180 deg.</p> <p>The <i>CONFigure:SUBArrays:IQRecorder</i> command defines a maximum of 32 subranges. If one of the statistical modes (<i>ARITHmetical, MINimum, MAXimum, IVAL</i>) is set, only one value is returned per subrange.</p> <p>N denotes the total number of returned values. The status indicators are described on p. 6.88.</p> | | | | |

| | | Magnitude values | | |
|---|--|--|-----------|----------|
| READ:SUBArrays:IQRecorder:LEVel? | | Start single shot measurement and return results | | |
| FETCh:SUBArrays:IQRecorder:LEVel? | | Read out meas. results (unsynchronized) | | |
| SAMPlE:SUBArrays:IQRecorder:LEVel? | | Read out measurement results (synchronized) | | |
| Returned values | Description of parameters | Def. value | Def. unit | FW vers. |
| OK NTR OFLW INV, | Measurement status indicators | INV | – | V3.80 |
| 1 N, | Number of values | NAN | – | |
| –100 dBm to +60 dBm, | 1 st value for magnitude (status = OK only) | NAN | dBm | |
| ... | ... | NAN | dBm | |
| –100 dBm to +60 dBm | N th value for magnitude (status = OK only) | NAN | dBm | |
| Description of command | | | | |
| <p>These commands are always queries. They start a <i>IQRecorder</i> measurement (<i>READ...</i>) and/or return the magnitudes in the subranges defined by means of the <i>CONFigure:SUBArrays:IQRecorder</i> command (see p. 6.86). A polar format (<i>CONFigure:IQRecorder:CONTRol:RMODe PLW PLUW</i>) must be active to obtain valid results. If the magnitude is expressed as an equivalent voltage, the output values are approx. in the range $2.2 \cdot 10^{-6}$ V to 220 V.</p> <p>The <i>CONFigure:SUBArrays:IQRecorder</i> command defines a maximum of 32 subranges. If one of the statistical modes (<i>ARITHmetical, MINimum, MAXimum, IVAL</i>) is set, only one value is returned per subrange.</p> <p>N denotes the total number of returned values. The status indicators are described on p. 6.88.</p> | | | | |

| | | Phase and magnitude values | | |
|--|--|--|-----------|----------|
| READ:SUBarrays:IQRecorder:PL? | | Start single shot measurement and return results | | |
| FETCh:SUBarrays:IQRecorder:PL? | | Read out meas. results (unsynchronized) | | |
| SAMPlE:SUBarrays:IQRecorder:PL? | | Read out measurement results (synchronized) | | |
| Returned values | Description of parameters | Def. value | Def. unit | FW vers. |
| OK NTR OFLW INV, 1 N, -180 deg to +180 deg, -100 dBm to +60 dBm, ..., -180 deg to +180 deg, -100 dBm to +60 dBm | Measurement status indicators | INV | – | V3.80 |
| | Number of values | NAN | – | |
| | 1 st value for phase (status = OK only) | NAN | deg | |
| | 1 st value for magnitude (status = OK only) | NAN | dBm | |
| | ... | NAN | | |
| | N th value for phase (status = OK only) | NAN | deg | |
| N th value for magnitude (status = OK only) | NAN | dBm | | |
| Description of command | | | | |
| These commands are always queries. They start a <code>IQRecorder</code> measurement (<code>READ...</code>) and/or return the phases and magnitudes in the subranges defined by means of the <code>CONFigure:SUBarrays:IQRecorder</code> command (see p. 6.86). A polar format (<code>CONFigure:IQRecorder:CONTRol:RMODE PLW PLUW</code>) must be active to obtain valid results. In the unwrapped phase format (<code>PLUW</code>), the phase is not restricted to the range between -180 deg and $+180$ deg. If the magnitude is expressed as an equivalent voltage, the output values are approx. in the range $2.2 \cdot 10^{-6}$ V to 220 V. | | | | |
| The <code>CONFigure:SUBarrays:IQRecorder</code> command defines a maximum of 32 subranges. If one of the statistical modes (<code>ARITHmetical</code> , <code>MINimum</code> , <code>MAXimum</code> , <code>IVal</code>) is set, only one value is returned per subrange. | | | | |
| N denotes the total number of returned values. The status indicators are described on p. 6.88. | | | | |

| | | I amplitudes | | |
|---|--|--|-----------|----------|
| READ:SUBarrays:IQRecorder:I? | | Start single shot measurement and return results | | |
| FETCh:SUBarrays:IQRecorder:I? | | Read out meas. results (unsynchronized) | | |
| SAMPlE:SUBarrays:IQRecorder:I? | | Read out measurement results (synchronized) | | |
| Returned values | Description of parameters | Def. value | Def. unit | FW vers. |
| OK NTR OFLW INV, 1 N, -220 V to +220 V, ..., -220 V to +220 V | Measurement status indicators | INV | – | V3.80 |
| | Number of values | NAN | – | |
| | 1 st value for I amplitude (status = OK only) | NAN | V | |
| | ... | NAN | V | |
| | N th value for I amplitude (status = OK only) | NAN | V | |
| | | | | |
| Description of command | | | | |
| These commands are always queries. They start a <code>IQRecorder</code> measurement (<code>READ...</code>) and/or return the I amplitudes in the subranges defined by means of the <code>CONFigure:SUBarrays:IQRecorder</code> command (see p. 6.86). The rectangular format (<code>CONFigure:IQRecorder:CONTRol:RMODE IQ</code>) must be active to obtain valid results. | | | | |
| The <code>CONFigure:SUBarrays:IQRecorder</code> command defines a maximum of 32 subranges. If one of the statistical modes (<code>ARITHmetical</code> , <code>MINimum</code> , <code>MAXimum</code> , <code>IVal</code>) is set, only one value is returned per subrange. | | | | |
| N denotes the total number of returned values. The status indicators are described on p. 6.88. | | | | |

| | | Q amplitudes | | |
|---|--|--|-----------|----------|
| READ:SUBarrays:IQRecorder:Q? | | Start single shot measurement and return results | | |
| FETCh:SUBarrays:IQRecorder:Q? | | Read out meas. results (unsynchronized) | | |
| SAMPlE:SUBarrays:IQRecorder:Q? | | Read out measurement results (synchronized) | | |
| Returned values | Description of parameters | Def. value | Def. unit | FW vers. |
| OK NTR OFLW INV, 1 N, -220 V to +220 V, ..., -220 V to +220 V | Measurement status indicators | INV | – | V3.80 |
| | Number of values | NAN | – | |
| | 1 st value for Q amplitude (status = OK only) | NAN | V | |
| | ... | NAN | V | |
| | N th value for Q amplitude (status = OK only) | NAN | V | |
| Description of command | | | | |
| These commands are always queries. They start a <code>IQRecorder</code> measurement (<code>READ...</code>) and/or return the Q amplitudes in the subranges defined by means of the <code>CONFigure:SUBarrays:IQRecorder</code> command (see p. 6.86). The rectangular format (<code>CONFigure:IQRecorder:CONTRol:RMODe IQ</code>) must be active to obtain valid results. | | | | |
| The <code>CONFigure:SUBarrays:IQRecorder</code> command defines a maximum of 32 subranges. If one of the statistical modes (<code>ARITHmetical</code> , <code>MINimum</code> , <code>MAXimum</code> , <code>IVAL</code>) is set, only one value is returned per subrange. | | | | |
| N denotes the total number of returned values. The status indicators are described on p. 6.88. | | | | |

| | | I and Q amplitudes | | |
|---|--|--|-----------|----------|
| READ:SUBarrays:IQRecorder:IQ? | | Start single shot measurement and return results | | |
| FETCh:SUBarrays:IQRecorder:IQ? | | Read out meas. results (unsynchronized) | | |
| SAMPlE:SUBarrays:IQRecorder:IQ? | | Read out measurement results (synchronized) | | |
| Returned values | Description of parameters | Def. value | Def. unit | FW vers. |
| OK NTR OFLW INV, 1 N, -220 V to +220 V, -220 V to +220 V, ..., -220 V to +220 V -220 V to +220 V | Measurement status indicators | INV | – | V3.80 |
| | Number of values | NAN | – | |
| | 1 st value for I amplitude (status = OK only) | NAN | V | |
| | 1 st value for Q amplitude (status = OK only) | NAN | V | |
| | ... | NAN | V | |
| | N th value for I amplitude (status = OK only) | NAN | V | |
| N th value for Q amplitude (status = OK only) | NAN | V | | |
| Description of command | | | | |
| These commands are always queries. They start a <code>IQRecorder</code> measurement (<code>READ...</code>) and/or return the I and Q amplitudes in the subranges defined by means of the <code>CONFigure:SUBarrays:IQRecorder</code> command (see p. 6.86). The rectangular format (<code>CONFigure:IQRecorder:CONTRol:RMODe IQ</code>) must be active to obtain valid results. | | | | |
| The <code>CONFigure:SUBarrays:IQRecorder</code> command defines a maximum of 32 subranges. If one of the statistical modes (<code>ARITHmetical</code> , <code>MINimum</code> , <code>MAXimum</code> , <code>IVAL</code>) is set, only one value is returned per subrange. | | | | |
| N denotes the total number of returned values. The status indicators are described on p. 6.88. | | | | |

Binary Results – Subsystem IQRecorder:BINary:ARRay

The subsystem *IQRecorder:BINary:ARRay...?* measures and returns the *I/Q Recorder* results in binary format. Each value is coded as a 32-bit (4-byte) IEEE 754 floating point number. The general format of an output string is described in **Table 6-4** unten.

Table 6-4 Binary output format

| Parameter | Format | Values, Range | Description |
|---|--------|---|--|
| Status | ASCII | [OK, NTR, OFLW, INV] | Validity of the captured data |
| #L | ASCII | [1, ..., 6] | Number of digits of the following counter N |
| N | ASCII | [4, ..., 262144] with option R&S CMU-U65 V02 or R&S CMU-U65 V04 [4, ..., 131072] without option | Total number of the following data bytes N = 4 * capture length (CONFigure: IQRecorder:CONTrol:CLEngth). |
| Value _i with i=1 to N/4 | BINARY | byte _{i,1} byte _{i,2} byte _{i,3} byte _{i,4} with i=1 to N/4 | 32-bit (4-byte) IEEE 754 floating point number in little-endian byte order (the least significant byte is sent first, the rightmost bytes in the example below are most significant) |
| EOS | ASCII | Hex: 0x0D0A | End of string character, [0x0D = carriage return] & [0x0A = line feed] |
| <p>Example of valid measurement output data with capture length 16 (and therefore N = 64): {OK,#264 byte_{1,1} byte_{1,2} byte_{1,3} byte_{1,4} byte_{2,1} byte_{2,2} byte_{2,3}byte_{2,4} ... byte_{16,1}byte_{16,2}byte_{16,3}byte_{16,4} EOS} Note that a comma separates the status indicator from the data part. In the combined phase/magnitude and I/Q commands (READ..PL?, READ:...:IQ? etc.) the number of bytes is doubled and N is replaced by 2*N.</p> <p>Output in case of errors:</p> <ul style="list-style-type: none"> {INV} Invalid measurement data (e.g. because the wrong format was selected) {NTR} No trigger event received during the <i>capture timeout</i> (CONFigure: IQRecorder:CONTrol:CTIMEout) {OFLW} Overflow, input path overdriven | | | |

| | | Phase values | | |
|---|--|--------------|-----------|----------|
| READ:BINary:ARRay:IQRecorder:PHASe? | Start single shot measurement and return results | | | |
| FETCh:BINary:ARRay:IQRecorder:PHASe? | Read out meas. results (unsynchronized) | | | |
| SAMPle:BINary:ARRay:IQRecorder:PHASe? | Read out measurement results (synchronized) | | | |
| Returned values | Description of parameters | Def. value | Def. unit | FW vers. |
| OK NTR OFLW INV, | Measurement status indicators | INV | – | V3.80 |
| L | Number of digits of N (status = OK only) | – | – | |
| N | Number of data bytes (status = OK only) | – | – | |
| <–180 deg to +180 deg> | 1 st value for phase (status = OK only) | – | deg | |
| ... | | – | deg | |
| <–180 deg to +180 deg> | N/4 th value for phase (status = OK only) | – | deg | |
| EOS | End of string (status = OK only) | – | – | |
| Description of command | | | | |
| These commands are always queries. They start a <i>IQRecorder</i> measurement (READ...) and/or return the phases in the binary format described in Table 6-4 on p. 6.93. Each phase value is coded as a 32-bit (4-byte) IEEE 754 floating point number. A polar format (CONFigure: IQRecorder:CONTrol :RMODE PLW PLUW) must be active to obtain valid results. In the unwrapped phase format (PLUW), the phase is not restricted to the range between –180 deg and +180 deg. | | | | |
| N denotes four times the total number of samples acquired (capture length, CONFigure: IQRecorder :CONTrol:CLEngth). | | | | |

| | | Magnitude values | | |
|---|--|--|-----------|----------|
| READ:BINary:ARRay:IQRecorder:LEVel? | | Start single shot measurement and return results | | |
| FETCh:BINary:ARRay:IQRecorder:LEVel? | | Read out meas. results (unsynchronized) | | |
| SAMPlE:BINary:ARRay:IQRecorder:LEVel? | | Read out measurement results (synchronized) | | |
| Returned values | Description of parameters | Def. value | Def. unit | FW vers. |
| OK NTR OFLW INV, | Measurement status indicators | INV | – | V3.80 |
| L | Number of digits of N (status = OK only) | – | – | |
| N | Number of data bytes (status = OK only) | – | – | |
| <-100 dBm to +60 dBm> | 1 st value for magnitude (status = OK only) | – | dBm | |
| ... | | – | dBm | |
| <-100 dBm to +60 dBm> | N/4 th value for magnitude (status = OK only) | – | dBm | |
| EOS | End of string (status = OK only) | – | – | |
| Description of command | | | | |
| <p>These commands are always queries. They start a <code>IQRecorder</code> measurement (<code>READ...</code>) and/or return the magnitudes in the binary format described in Table 6-4 on p. 6.93. Each magnitude value is coded as a 32-bit (4-byte) IEEE 754 floating point number. A polar format (<code>CONFigure:IQRecorder:CONTRol:RMODe PLW PLUW</code>) must be active to obtain valid results. If the magnitude is expressed as an equivalent voltage, the output values are approx. in the range $2.2 \cdot 10^{-6}$ V to 220 V.</p> <p>N denotes four times the total number of samples acquired (capture length, <code>CONFigure:IQRecorder:CONTRol:CLENgth</code>).</p> | | | | |

| | | Phase and magnitude values | | |
|---|--|--|-----------|----------|
| READ:BINary:ARRay:IQRecorder:PL? [<Order>] | | Start single shot measurement and return results | | |
| FEtCh:BINary:ARRay:IQRecorder:PL? [<Order>] | | Read out meas. results (unsynchronized) | | |
| SAMPlE:BINary:ARRay:IQRecorder:PL? [<Order>] | | Read out measurement results (synchronized) | | |
| <Order> | Description of parameters | Def. value | Def. unit | FW vers. |
| NORMal | All phases first, then all magnitudes | NORMal | – | V3.80 |
| ALTErnate | Alternating phases and magnitudes (see below) | | | |
| Returned values, normal order | Description of parameters | Def. value | Def. unit | FW vers. |
| OK NTR OFLW INV, L | Measurement status indicators | INV | – | V3.80 |
| 2*N | Number of digits of 2*N (status = OK only) | – | – | |
| <-180 deg to +180 deg> | Number of data bytes (status = OK only) | – | – | |
| ... | 1 st value for phase (status = OK only) | – | deg | |
| <-180 deg to +180 deg> | N/4 th value for phase (status = OK only) | – | deg | |
| <-100 dBm to +60 dBm> | 1 st value for magnitude (status = OK only) | – | dBm | |
| ... | N/4 th value for magnitude (status = OK only) | – | dBm | |
| <-100 dBm to +60 dBm> | End of string (status = OK only) | – | – | |
| EOS | | | | |
| Returned values, altern. order | Description of parameters | Def. value | Def. unit | FW vers. |
| OK NTR OFLW INV, L | Measurement status indicators | INV | – | V3.80 |
| 2*N | Number of digits of 2*N (status = OK only) | – | – | |
| <-180 deg to +180 deg> | Number of data bytes (status = OK only) | – | – | |
| ... | 1 st value for phase (status = OK only) | – | deg | |
| <-180 deg to +180 deg> | 1 st value for magnitude (status = OK only) | – | dBm | |
| <-100 dBm to +60 dBm> | | – | | |
| ... | N/4 th value for phase (status = OK only) | – | deg | |
| <-180 deg to +180 deg> | N/4 th value for magnitude (status = OK only) | – | dBm | |
| <-100 dBm to +60 dBm> | | – | | |
| EOS | End of string (status = OK only) | – | – | |
| Description of command | | | | |
| <p>These commands are always queries. They start a IQRecorder measurement (READ...) and/or return the phases and magnitudes in the binary format described in Table 6-4 on p. 6.93. Each phase and each magnitude value is coded as a 32-bit (4-byte) IEEE 754 floating point number. A polar format (CONFigure:IQRecorder:CONTRol:RMODe PLW PLUW) must be active to obtain valid results. In the unwrapped phase format (PLUW), the phase is not restricted to the range between –180 deg and +180 deg. If the magnitude is expressed as an equivalent voltage, the output values are approx. in the range $2.2 \cdot 10^{-6}$ V to 220 V.</p> <p>N denotes four times the total number of samples acquired (capture length, CONFigure:IQRecorder:CONTRol:CLEngth).</p> | | | | |

| | | I amplitudes | | |
|---|--|--|-----------|----------|
| READ:BINary:ARRay:IQRecorder:I? | | Start single shot measurement and return results | | |
| FETCh:BINary:ARRay:IQRecorder:I? | | Read out meas. results (unsynchronized) | | |
| SAMPlE:BINary:ARRay:IQRecorder:I? | | Read out measurement results (synchronized) | | |
| Returned values | Description of parameters | Def. value | Def. unit | FW vers. |
| OK NTR OFLW INV, | Measurement status indicators | INV | – | V3.80 |
| L | Number of digits of N (status = OK only) | – | – | |
| N | Number of data bytes (status = OK only) | – | – | |
| <-220 V to +220 V> | 1 st value for I amplitude (status = OK only) | – | V | |
| ... | | – | V | |
| <-220 V to +220 V> | N/4 th value for I amplitude (status = OK only) | – | V | |
| EOS | End of string (status = OK only) | – | – | |
| Description of command | | | | |
| <p>These commands are always queries. They start a <code>IQRecorder</code> measurement (<code>READ...</code>) and/or return the I amplitudes in the binary format described in Table 6-4 on p. 6.93. Each amplitude value is coded as a 32-bit (4-byte) IEEE 754 floating point number. The rectangular format (<code>CONFigure:IQRecorder:CONTRol:RMODE IQ</code>) must be active to obtain valid results.</p> <p>N denotes four times the total number of samples acquired (capture length, <code>CONFigure:IQRecorder:CONTRol:CLENgth</code>).</p> | | | | |

| | | Q amplitudes | | |
|---|--|--|-----------|----------|
| READ:BINary:ARRay:IQRecorder:Q? | | Start single shot measurement and return results | | |
| FETCh:BINary:ARRay:IQRecorder:Q? | | Read out meas. results (unsynchronized) | | |
| SAMPlE:BINary:ARRay:IQRecorder:Q? | | Read out measurement results (synchronized) | | |
| Returned values | Description of parameters | Def. value | Def. unit | FW vers. |
| OK NTR OFLW INV, | Measurement status indicators | INV | – | V3.80 |
| L | Number of digits of N (status = OK only) | – | – | |
| N | Number of data bytes (status = OK only) | – | – | |
| <-220 V to +220 V> | 1 st value for Q amplitude (status = OK only) | – | V | |
| ... | | – | V | |
| <-220 V to +220 V> | N/4 th value for Q amplitude (status = OK only) | – | V | |
| EOS | End of string (status = OK only) | – | – | |
| Description of command | | | | |
| <p>These commands are always queries. They start a <code>IQRecorder</code> measurement (<code>READ...</code>) and/or return the Q amplitudes in the binary format described in Table 6-4 on p. 6.93. Each amplitude value is coded as a 32-bit (4-byte) IEEE 754 floating point number. The rectangular format (<code>CONFigure:IQRecorder:CONTRol:RMODE IQ</code>) must be active to obtain valid results.</p> <p>N denotes four times the total number of samples acquired (capture length, <code>CONFigure:IQRecorder:CONTRol:CLENgth</code>).</p> | | | | |

| | | I and Q amplitudes | | |
|---|--|--|-----------|----------|
| READ:BINary:ARRay:IQRecorder:IQ? [<Order>] | | Start single shot measurement and return results | | |
| FEtCh:BINary:ARRay:IQRecorder:IQ? [<Order>] | | Read out meas. results (unsynchronized) | | |
| SAMPlE:BINary:ARRay:IQRecorder:IQ? [<Order>] | | Read out measurement results (synchronized) | | |
| <Order> | Description of parameters | Def. value | Def. unit | FW vers. |
| NORMal | All I amplitudes first, then all Q amplitudes | NORMal | – | V3.80 |
| ALTeRNate | Alternating I and Q amplitudes (see below) | | | |
| Returned values, norm. order | Description of parameters | Def. value | Def. unit | FW vers. |
| OK NTR OFLW INV, L | Measurement status indicators | INV | – | V3.80 |
| 2*N | Number of digits of 2*N (status = OK only) | – | – | |
| <-220 V to +220 V> | Number of data bytes (status = OK only) | – | – | |
| <-220 V to +220 V> | 1 st value for I amplitude (status = OK only) | – | V | |
| ... | | – | V | |
| <-220 V to +220 V> | N/4 th value for I amplitude (status = OK only) | – | V | |
| <-220 V to +220 V> | 1 st value for Q amplitude (status = OK only) | – | V | |
| ... | | – | V | |
| <-220 V to +220 V> | N/4 th value for Q amp. (status = OK only) | – | V | |
| EOS | End of string (status = OK only) | – | – | |
| Returned values, alt. order | Description of parameters | Def. value | Def. unit | FW vers. |
| OK NTR OFLW INV, L | Measurement status indicators | INV | – | V3.80 |
| 2*N | Number of digits of 2*N (status = OK only) | – | – | |
| <-220 V to +220 V> | Number of data bytes (status = OK only) | – | – | |
| <-220 V to +220 V> | 1 st value for I amplitude (status = OK only) | – | V | |
| ... | | – | V | |
| <-220 V to +220 V> | 1 st value for Q amplitude (status = OK only) | – | V | |
| ... | | – | V | |
| <-220 V to +220 V> | N/4 th value for I amplitude (status = OK only) | – | V | |
| <-220 V to +220 V> | N/4 th value for Q amp. (status = OK only) | – | V | |
| EOS | End of string (status = OK only) | – | – | |
| Description of command | | | | |
| <p>These commands are always queries. They start a IQRecorder measurement (READ...) and/or return the I and Q amplitudes in the binary format described in Table 6-4 on p. 6.93. Each amplitude value is coded as a 32-bit (4-byte) IEEE 754 floating point number. The rectangular format (CONFigure:IQRecorder:CONTRol:RMoDe IQ) must be active to obtain valid results.</p> <p>N denotes four times the total number of samples acquired (capture length, CONFigure:IQRecorder:CONTRol:CLenGth).</p> | | | | |

I/Q vs. Slot (IQSLot)

The subsystem *IQSLot* measures the I and Q amplitudes in a sequence of consecutive measurement steps. The subsystem corresponds to the measurement menu *I/Q vs. Slot* and the associated popup menu *I/Q vs. Slot Configuration*.

Measurement Control

The following commands control the *I/Q vs. Slot* measurement. They correspond to the *I/Q vs. Slot* measurement control softkey.

| | | |
|--|--|--------------|
| INITiate:IQSLot | Start new measurement | ⇒ <i>RUN</i> |
| ABORt:IQSLot | Abort running measurement and switch off | ⇒ <i>OFF</i> |
| STOP:IQSLot ⇒ <i>STOP</i> | Stop measurement after current evaluation period | |
| CONTinue:IQSLot | Next measurement step (only <i>stepping mode</i>) | ⇒ <i>RUN</i> |
| Command description | | FW vers. |
| These commands have no query form. They start or stop the measurement, setting it to the status indicated in the top right column. | | V3.80 |

| CONFigure:IQSLot:EREPorting <Mode> | | Event reporting of the measurement | | |
|--|---------------------------|------------------------------------|-----------|----------|
| <Mode> | Parameter description | Def. value | Def. unit | FW vers. |
| SRQ | Service request | OFF | – | V3.80 |
| SOPC | Single operation complete | | | |
| SRSQ | SRQ and SOPC | | | |
| OFF | No reporting | | | |
| Command description | | | | |
| This command defines the events generated when the measurement is terminated or stopped (<i>event reporting</i> , see chapter 5 of the operating manual). | | | | |

| FETCH:IQSLot:STATus? | | | | |
|--|---|------------|-----------|----------|
| Measurement status | | | | |
| Returned value | Parameter description | Def. value | Def. unit | FW vers. |
| OFF | Measurement in the OFF state (*RST or ABORt) | OFF | – | V3.80 |
| RUN | Running (after INITiate, CONTinue or READ) | | | |
| STOP | Stopped (STOP) | | | |
| ERR | OFF (could not be started) | | | |
| STEP | Stepping mode (<stepmode>=STEP) | | | |
| RDY, | Stopped according to repetition mode and stop condition | | | |
| 0 to 10000 | Counter for measurement cycles | NONE | – | |
| NONE | Counter not used | | | |
| 1 to 1000 | Counter for current step within a measurement cycle | NONE | – | |
| NONE | Only one step measured | | | |
| Command description | | | | |
| This command is always a query. It returns the status of the measurement (see chapters 3 and 5). | | | | |

Test Configuration

The commands in the following subsystems configure the IQSlot measurement. They correspond to the I/Q vs. Slot Configuration popup menu. The following figure explains the essential test settings:

Example 1: Power trigger, all steps including the first one are equidistant

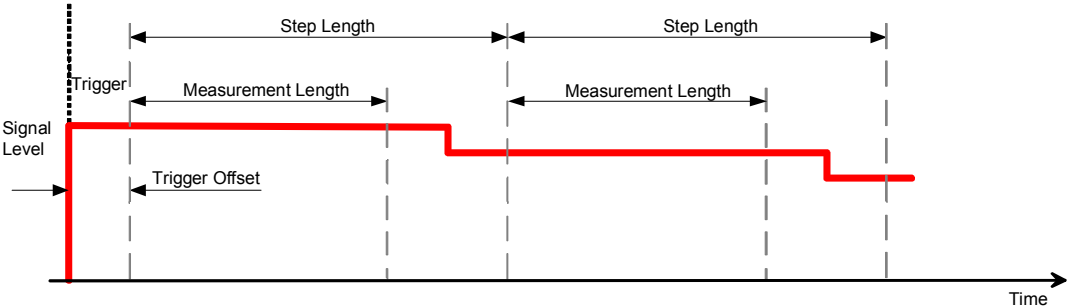

Example 2: Power trigger, first step is longer than the others

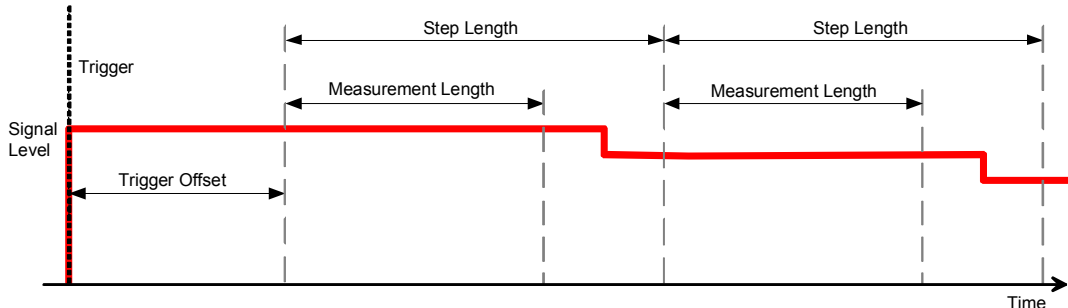

Example 3: External trigger occurs before the first step

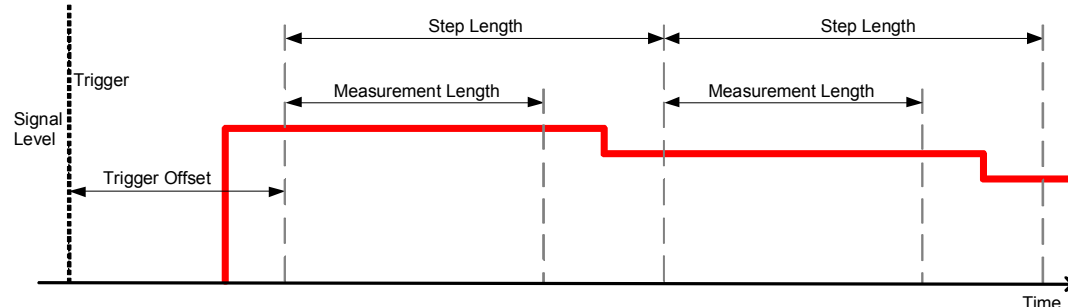

Figure 6-1 Step Length, Measurement Length and Trigger Offset

| DEFault:IQSLot:CONTRol <Enable> | | Default Settings | | |
|--|--|------------------|-----------|----------|
| <Enable> | Description of parameters | Def. value | Def. unit | FW vers. |
| ON OFF | The parameters are set to default values Some or all parameters are not set to default values | ON | – | V3.80 |
| Description of command | | | | |
| If used as a setting command with the parameter ON, this command sets all parameters of the subsystem to their default values (the setting OFF results in an error message). | | | | |
| If used as a query the command returns whether all parameters are set to their default values (ON) or not (OFF). | | | | |

| CONFigure:IQSLot:CONTRol:REPetition <Repetition> ,<StopCondition>,<Stepmode> | | Measurement cycles | | |
|---|--|--------------------|-----------|----------|
| <Repetition> | Parameter description | Def. value | Def. unit | FW vers. |
| CONTinuous SINGleshot 1 to 10000 | Continuous measurement (until STOP or ABORT) Single shot measurement (until Status = RDY) Multiple measurement (counting, until Status = STEP RDY) | SING | – | V3.80 |
| <StopCondition> | Parameter description | Def. value | Def. unit | FW vers. |
| NONE | Dummy parameter (for future extensions) | NONE | – | V3.80 |
| <Stepmode> | Description of parameters | Def. value | Def. unit | FW vers. |
| STEP NONE | Interrupt measurement after each statistics cycle Continue measurement according to its rep. mode | NONE | – | V3.80 |
| Command description | | | | |
| This command defines the repetition mode and the stepping mode for the measurement. A stop condition (second parameter in other measurements) is not available. | | | | |
| Note: In the case of READ commands (READ:...IQSLot...?) the <Repetition> parameter has no effect; the measurement is always stopped after a single shot. | | | | |

| CONFigure:IQSLot:CONTRol:NOSTeps <Steps> | | Number of Steps | | |
|--|-----------------------------|-----------------|--------------|----------|
| <Steps> | Parameter description | Def. value | Default unit | FW vers. |
| 1 to 1000 | Steps per measurement cycle | 10 | – | V3.80 |
| Command description | | | | |
| This command defines the number of steps per measurement cycle: a single shot measurement is complete after the specified number of steps. | | | | |

| CONFigure:IQSLot:CONTRol:NOSubsweeps <Subsweeps> | | Number of Subsweeps | | |
|--|---------------------------------|---------------------|--------------|----------|
| <Subsweeps> | Parameter description | Def. value | Default unit | FW vers. |
| 1 to 20 | Subsweeps per measurement cycle | 1 | – | V4.20 |
| Command description | | | | |
| This command defines the number of subsweeps per measurement cycle: a single shot measurement is complete after the specified number of subsweeps. | | | | |
| The default value '1' defines a single-sweep measurement. | | | | |
| Note: The multiple subsweep feature requires CMU-U65 (var. 04). | | | | |

| CONFigure:IQSLot:CONTRol:TOFFset <Time> | | | | Trigger Offset |
|---|-----------------------|------------|--------------|----------------|
| <Time> | Parameter description | Def. value | Default unit | FW vers. |
| 0 μs to 32768 μs | Trigger offset | 10 | μs | V3.80 |
| Command description | | | | |
| This command defines an offset between the trigger event (power or external trigger: TRIGger:[SEQuence:]SOURce RFPower IFPower EXTern) and the start of the measurement (see Figure 6-1 on p. 6.99). The trigger offset is ignored for a free run measurement (TRIGger:[SEQuence:]SOURce IMMeditate). | | | | |

| CONFigure:IQSLot:CONTRol:SLENgth <Time> | | | | Step Length |
|---|-----------------------|------------|--------------|-------------|
| <Time> | Parameter description | Def. value | Default unit | FW vers. |
| 128 μs to 16384 μs | Step length | 128 | μs | V3.80 |
| Command description | | | | |
| This command defines the length of each step (see Figure 6-1 on p. 6.99). To measure a series of power steps the sum of the measurement length (CONFigure:IQSLot:CONTRol:MLENgth) plus the trigger offset (CONFigure:IQSLot:CONTRol:TOFFset) should not exceed the step length. | | | | |

| CONFigure:IQSLot:CONTRol:MLENgth <Time> | | | | Measurement Length |
|---|-----------------------|------------|--------------|--------------------|
| <Time> | Parameter description | Def. value | Default unit | FW vers. |
| 128 μs to 8192 μs | Measurement length | 128 | μs | V3.80 |
| Command description | | | | |
| This command defines the measurement length within each step (see Figure 6-1 on p. 6.99). All I/Q results are averaged over the measurement length so that a single complex result is obtained for each step. To measure a series of power steps the sum of the measurement length plus the trigger offset (CONFigure:IQSLot:CONTRol:TOFFset) should not exceed the step length (CONFigure:IQSLot:CONTRol:SLENgth). | | | | |

| CONFigure:IQSLot:CONTRol:FELimit <Level> | | | | Frequency Estimation Limit |
|---|----------------------------|------------|--------------|----------------------------|
| <Level> | Parameter description | Def. value | Default unit | FW vers. |
| -200 dB to -30 dB | Frequency Estimation Limit | -30 | dB | V3.80 |
| Command description | | | | |
| This command defines a threshold for the average levels in the slots that is relevant for the frequency offset estimate: Slots below the threshold are not considered for the estimate. | | | | |

| CONFigure:IQSLot:CONTRol:CTIMEout <Timeout> | | | | Capture Timeout |
|--|--|------------|--------------|-----------------|
| <Timeout> | Parameter description | Def. value | Default unit | FW vers. |
| 0.1 s to 60.0 s | Timeout period (in multiples of 0.1 s) after which the I/Q vs. Slot measurement is aborted when the R&S CMU receives no trigger event after arming the trigger system. | 1.0 s | 0.1 s | V4.20 |
| Command description | | | | |
| This command specifies a maximum time between the start of the measurement and the trigger time in tenths of a second (numeric entry: 1 to 600). The I/Q Slot measurement must be triggered (no free run mode).. | | | | |

Display Configuration

The following command selects the display format for the complex *I/Q* vs. *Slot* results. It corresponds to the *Display* softkey in the measurement menu and to the associated hotkeys.

| CONFigure:IQSLot:SELECTION <Format> | | | | Display Format |
|---|-------------------------------------|------------|--------------|----------------|
| <Format> | Parameter description | Def. value | Default unit | FW vers. |
| IQ | Complex format (I and Q amplitudes) | IQ | – | V3.80 |
| LP | Polar format (level and phase) | | | |
| Command description | | | | |
| <p>This command selects the display format for the complex <i>I/Q</i> vs. <i>Slot</i> results. The measurement results retrieved via <code>READ:ARRAY:IQSLot:I?</code>, <code>READ:ARRAY:IQSLot:Q?</code>, <code>READ:ARRAY:IQSLot:LEVEL?</code>, <code>READ:ARRAY:IQSLot:PHASE?</code> etc. must be accordance with the current display format.</p> <p>Example: While the complex format (IQ) is active, the command <code>READ:ARRAY:IQSLot:LEVEL?</code> causes an execution error.</p> | | | | |

Subarray Definition

The subsystem *SUBarrays:IQSLot* defines the measurement range and the type of output values.

| CONFigure:SUBarrays:IQSLot <Mode>,<Start>,<Samples>{,<Start>,<Samples>} | | Definition of Subarrays | | |
|---|---|-------------------------|-----------|----------|
| <Mode> | Description of parameters | Def. value | Def. unit | FW vers. |
| ALL ARITHmetical MINimum MAXimum IVAL XMAXimum XMINimum PAVG , | Return all measurement values Return arithm. mean value in every subrange Return minimum value in every subrange Return maximum value in every subrange Return single interpolated value at <Start> Return x-axis value of maximum and maximum Return x-axis value of minimum and minimum Return arithmetic mean value in every subrange | ALL | – | V3.80 |
| <Start> | Description of parameters | Def. value | Def. unit | FW vers. |
| 1 to N^{*)}, | First step in current range | Min | – | V3.80 |
| <Samples> | Description of parameters | Def. value | Def. unit | FW vers. |
| 1 to N^{*)} | Number of steps in current subrange | Max | – | V3.80 |
| Description of command | | | | |
| <p>This command configures the <code>READ:SUBarrays:IQSLot...</code>, <code>FETCh:SUBarrays:IQSLot...</code>, and <code>SAMPLe:SUBarrays:IQSLot</code> commands. It restricts the measurement to up to 32 subranges where either all measurement results (the number of which is given by the second numerical parameter) or a single statistical value is returned. The subranges are defined by the first measured step and the number of steps to be measured.</p> <p>For <Mode> = IVAL, the <Samples> parameter is ignored and the CMU returns a single measurement value for step no. <Start>.</p> <p>The subranges may overlap but can not exceed the total number N of measured steps. Steps with numbers above N are not measured (result NAN) and do not enter into the <code>ARITHmetical</code>, <code>MINimum</code> and <code>MAXimum</code> values.</p> <p>By default, only one range corresponding to the total measurement range is used and all measurement values are returned.</p> <p>^{*)} N denotes the total number of steps measured, defined via <code>CONFigure:IQSLot:CONTrol:NOSTeps</code>.</p> | | | | |

Retrieving Results

The following commands return the results of the *I/Q vs. Slot* measurement. The subsystem corresponds to the diagrams in the measurement menu *I/Q vs. Slot*.

| FETCh[:SCALar]:IQSLot:FREQUENCY:OFFSet? | | Frequency Error ⇒ RUN | | |
|--|-------------------------|--------------------------|--------------|----------|
| Read meas. results (unsynchronized) | | | | |
| Returned values: I and Q amplitudes | Parameter description | Def. value | Default unit | FW vers. |
| –30000 Hz to +30000 Hz | Average frequency error | NAN | Hz | V3.80 |
| Command description | | | | |
| <p>This command is always a query. It returns the average frequency error determined in the <i>I/Q vs. Slot</i> measurement.</p> | | | | |

| | | | | |
|---|---|-------------------------------------|--------------|----------|
| READ:ARRay:IQSLot:I? READ:ARRay:IQSLot:Q? READ:ARRay:IQSLot:LEVel? READ:ARRay:IQSLot:PHASe? | | All I/Q vs. Slot Results | | |
| | Start single shot meas. and return results | ⇒ RUN | | |
| FETCh:ARRay:IQSLot:I? FETCh:ARRay:IQSLot:Q? FETCh:ARRay:IQSLot:LEVel? FETCh:ARRay:IQSLot:PHASe? | | Read meas. results (unsynchronized) | | |
| | | ⇒ RUN | | |
| SAMPlE:ARRay:IQSLot:I? SAMPlE:ARRay:IQSLot:Q? SAMPlE:ARRay:IQSLot:LEVel? SAMPlE:ARRay:IQSLot:PHASe? | | Read results (synchronized) | | |
| | | ⇒ RUN | | |
| Returned values: I and Q amplitudes | Parameter description | Def. value | Default unit | FW vers. |
| -20.0 V to +20.0 V, ..., -20.0 V to +20.0 V | 1 st value for I or Q amplitude N th *) value for I or Q amplitude | NAN NAN | V V | V3.80 |
| Returned values: Level | Parameter description | Def. value | Default unit | FW vers. |
| -90.0 dBm to +40.0 dBm, ..., -90.0 dBm to +40.0 dBm | 1 st value for level N th *) value for level | NAN NAN | dBm dBm | V3.80 |
| Returned values: Level | Parameter description | Def. value | Default unit | FW vers. |
| -180.0 deg to +180.0 deg, ..., -180.0 deg to +180.0 deg | 1 st value for phase N th *) value for phase | NAN NAN | deg deg | V3.80 |
| Command description | | | | |
| These commands are always queries. They return the IQSLot values versus time for all steps. The retrieved measurement results must be accordance with the current display format; see CONFigure:IQSLot:SElection. | | | | |
| *) N denotes the total number of steps measured, defined via CONFigure:IQSLot:CONTrol:NOSTeps. | | | | |

| | | | | |
|--|---|------------|--------------|----------|
| READ:SUBarrays:IQSLot:I? Subarray Results READ:SUBarrays:IQSLot:Q? READ:SUBarrays:IQSLot:LEVel? READ:SUBarrays:IQSLot:PHASe? Start single shot meas. and return results ⇒ RUN | | | | |
| FETCH:SUBarrays:IQSLot:I? FETCH:SUBarrays:IQSLot:Q? FETCH:SUBarrays:IQSLot:LEVel? FETCH:SUBarrays:IQSLot:PHASe? Read meas. results (unsynchronized) ⇒ RUN | | | | |
| SAMPlE:SUBarrays:IQSLot:I? SAMPlE:SUBarrays:IQSLot:Q? SAMPlE:SUBarrays:IQSLot:LEVel? SAMPlE:SUBarrays:IQSLot:PHASe? Read results (synchronized) ⇒ RUN | | | | |
| Returned values: I and Q amplitudes | Parameter description | Def. value | Default unit | FW vers. |
| -20.0 V to +20.0 V, ..., -20.0 V to +20.0 V | 1 st value for I or Q amplitude | NAN | V | V3.80 |
| | N th *) value for I or Q amplitude | NAN | V | |
| Returned values: Level | Parameter description | Def. value | Default unit | FW vers. |
| -90.0 dBm to +40.0 dBm, ..., -90.0 dBm to +40.0 dBm | 1 st value for level | NAN | dBm | V3.80 |
| | N th *) value for level | NAN | dBm | |
| Returned values: Level | Parameter description | Def. value | Default unit | FW vers. |
| -180.0 deg to +180.0 deg, ..., -180.0 deg to +180.0 deg | 1 st value for phase | NAN | deg | V3.80 |
| | N th *) value for phase | NAN | deg | |
| Command description | | | | |
| These commands are always queries. They return the IQSLot versus time in the subranges defined by means of the CONFIGure:SUBarrays:IQSLot command. In the default setting of the configuration command the READ:SUBarrays..., FETCH:SUBarrays..., and SAMPlE:SUBarrays... command group is equivalent to the READ:ARRay..., FETCH:ARRay..., and SAMPlE:ARRay... command group described above. | | | | |
| The retrieved measurement results must be accordance with the current display format; see CONFIGure:IQSLot:SElection. | | | | |
| *) N depends on the subranges defined via CONFIGure:SUBarrays:IQSLot. If one of the statistical modes (ARITHmetical, MINimum, MAXimum) or IVAL is set, only one value is returned by subrange. | | | | |

Audio Generator and Analyzer (Option R&S CMU-B41)

Audio measurements form a separate function group (*Audio Non Signalling* mode, AUDIO_NSig) with associated secondary address. The *Signalling* mode is not available for audio measurements. However, it is possible to perform audio measurements while using the signalling modes from other function groups (e.g. establish a call to a mobile in function group *GSM900-MS Signalling* and switch over to perform additional audio measurements). Consequently, additional audio-related commands may be provided in other contexts (for example, the ROUTe:SPENcoder... and ROUTe:SPDecoder... commands in the *GSM-MS* and other function groups).

The audio function group provides the following independent measurements:

- In a single-tone audio measurement, the R&S CMU generates an audio signal at constant level and frequency (see section *AF Generator (AFGenerator)* on p. 6.115) and analyzes a single-tone audio input signal (see section *Audio Analyzer (AFAnalyzer)* on p. 6.109).
- In a multitone measurement (see section *Multitone Measurement (MULTitone)* on p. 6.117), the R&S CMU generates a composite audio signal consisting of up to 20 distinct test tones and analyzes an audio input signal containing the same tones.
- In the total harmonic distortion (THD) measurement (see section *Total Harmonic Noise Measurement (THD)* on p. 6.140), the R&S CMU provides a single-frequency audio test signal with adjustable power and very low harmonic distortion and measures the AF power at the generator frequency (1st harmonic labeled d1) and at the 2nd, 3rd ... 9th harmonics.

Note: *The single-tone generator and the multitone audio measurement must not be running simultaneously. In manual control, this is ensured because the single-tone audio generator is automatically switched off upon switchover to the Multitone menu and vice versa. In remote control, the conflict must be resolved explicitly:*

- *The single tone AF generator must be switched off before a multitone measurement is started.*
- *A running multitone measurement must be aborted before the single tone AF generator is switched on.*

In the case of two conflicting audio measurements, the READ..., FETCH... commands will result in an error message.

Two independent audio circuits are provided:

- In the primary audio circuit (subsystems AFAnalyzer[:PRIMary] and AFGenerator[:PRIMary] for single tone measurements, MULTitone:AF1Channel and THD:AF1Channel for the other measurements), the audio signals are applied to the connectors AF OUT (output, AF generator signal) and AF IN (input) on the R&S CMU front panel. The [:PRIMary] single tone audio circuit corresponds to the *Analyzer 1* application in the *Audio Analyzer/Generator* menu. The MULTitone:AF1Channel and THD:AF1Channel audio circuits correspond to the *AF Chan. One* applications.
- In the secondary audio circuit (subsystems AFAnalyzer:SECondary and AFGenerator:SECondary for single tone measurements, MULTitone:AF2Channel and THD:AF2Channel for the other measurements), the audio signals are applied to the connectors AUX 2 (output, AF generator signal) and AUX 1 (input) on the R&S CMU front panel. The :SECondary single tone audio circuit corresponds to the *Analyzer 2* application in the *Audio Analyzer/Generator* menu. The MULTitone:AF2Channel and THD:AF2Channel audio circuits correspond to the *AF Chan. Two* applications.

With the exception of the input and output connectors, the two audio circuits are identical. Configurations such as the input path (AFLevel) can be set independently. All remote control commands are analogous.

The Stereo applications for the Multitone and THD measurements are combinations of the primary and secondary circuit applications.

Subsystem AFLevel (AF Input Level)

The subsystem AFLevel configures the input path for audio signals. The commands correspond to the Analyzer Level softkey in the Audio measurement menus with the hotkeys Mode and AF Max. Level. The settings are valid for all Audio applications; for an overview refer to the table below.

| Audio Channel | Manual Control, Menu | Application keyword | AFLevel keywords |
|--------------------------------------|-------------------------|---------------------|---------------------------|
| Single tone, channel 1 | Analyzer/Generator | [:PRIMary] | [:PRIMary] |
| Single tone, channel 2 | – | :SECondary | :SECondary |
| Multitone, channel 1 | Multitone, AF Chan. One | AF1Channel | [:PRIMary] |
| Multitone, channel 2 | Multitone, AF Chan. Two | AF2Channel | :SECondary |
| Multitone, stereo | Multitone, Stereo | STEReo | [:PRIMary] :SECondary |
| Total harmonic distortion, channel 1 | THD, AF Chan. One | AF1Channel | [:PRIMary] |
| Total harmonic distortion, channel 2 | THD, AF Chan. Two | AF2Channel | :SECondary |
| Total harmonic distortion, stereo | THD, Stereo | STEReo | [:PRIMary] :SECondary |

| [SENSe:]AFLevel[:PRIMary]:MODE <Mode> | | Input level – Mode | | |
|---|-------------------------------------|--------------------|-----------|----------|
| [SENSe:]AFLevel:SECondary:MODE <Mode> | | | | |
| <Mode> | Description of parameters | Def. value | Def. unit | FW vers. |
| MANual AUTomatic | Manual setting Automatic setting | AUT | – | V3.05 |
| Description of command | | | | |
| These commands select manual setting of the maximum input level via [SENSe:]AFLevel...:MAXimum or automatic setting according to the average power of the applied audio signal. In firmware versions <3.05, only one [SENSe:]AFLevel:MODE command is available to configure all audio channels. | | | | |

| [SENSe:]AFLevel[:PRIMary]:MAXimum <Level> | | AF Max. Level | | |
|--|-----------------------------|---------------|-----------|----------|
| [SENSe:]AFLevel:SECondary:MAXimum <Level> | | | | |
| <Level> | Description of parameters | Def. value | Def. unit | FW vers. |
| 0.05 mV to +30 V | Maximum audio input voltage | 1 | V | V3.05 |
| Description of command | | | | |
| This command defines the maximum expected AF input level. In firmware versions <3.05, only one [SENSe:]AFLevel:MAXimum command is available to configure all audio channels. | | | | |

| [SENSe:]AFLevel:DEFault | | Default Settings | | |
|---|---|------------------|-----------|----------|
| <Enable> | Description of parameters | Def. value | Def. unit | FW vers. |
| ON | The parameters are set to their default values | ON | – | V3.05 |
| OFF | Some or all parameters differ from the default values | | | |
| Description of command | | | | |
| If used as a setting command with the parameter <i>ON</i> this command sets all parameters of the subsystem to their default values (the setting <i>OFF</i> results in an error message). | | | | |
| If used as a query the command returns whether all parameters are set to their default values (<i>ON</i>) or not (<i>OFF</i>). | | | | |

Audio Analyzer (AFANalyzer)

The AFANalyzer subsystem measures the single tone audio signal. It corresponds to the *Analyzer* soft-key in the main menu *Audio Analyzer/Generator* and the associated output fields.

Subsystem AFANalyzer (Measurement Control)

The subsystem *AFANalyzer* controls the single-tone audio analysis.

| | | |
|---|---|---------------|
| INITiate:AFANalyzer[:PRIMary] | | Analyzer |
| INITiate:AFANalyzer:SECondary | Start new AF measurement | ⇒ <i>RUN</i> |
| STOP:AFANalyzer[:PRIMary] | | |
| STOP:AFANalyzer:SECondary | Stop AF measurement after current evaluation period | ⇒ <i>STOP</i> |
| ABORT:AFANalyzer[:PRIMary] | | |
| ABORT:AFANalyzer:SECondary | Abort and switch off AF analyzer | ⇒ <i>OFF</i> |
| CONTinue:AFANalyzer[:PRIMary] | | |
| CONTinue:AFANalyzer:SECondary | Next measurement step (only stepping mode) | ⇒ <i>RUN</i> |
| Description of command | | FW vers. |
| These commands have no query form. They start and stop the AF analyzer, setting it to the status given in the top right column. | | V2.10 |

| CONFigure:AFANalyzer[:PRIMary]:EREPorting <Mode> | | Event Reporting | | |
|---|---------------------------|-----------------|-----------|----------|
| <Mode> | Description of parameters | Def. value | Def. unit | FW vers. |
| SRQ | Service request | OFF | – | V2.10 |
| SOPC | Single operation complete | | | |
| SRSQ | SRQ and SRSQ | | | |
| OFF | No reporting | | | |
| Description of command | | | | |
| This command defines the events generated when the measurement is terminated or stopped (event reporting see chapter 5) | | | | |

| FETCh:AFANalyzer[:PRIMary]:STATus? FETCh:AFANalyzer:SECOndary:STATus? | | Measurement Status | | |
|---|---|--------------------|-----------|----------|
| Return | Description of parameters | Def. value | Def. unit | FW vers. |
| OFF | Measurement in the OFF state (*RST or ABORT) | OFF | – | V2.10 |
| RUN | Running (after INITiate, CONTinue or READ) | | | |
| STOP | Stopped (STOP) | | | |
| ERR | OFF (could not be started) | | | |
| STEP | Stepping mode (<stepmode> = STEP) | | | |
| RDY , | Stopped according to repetition mode and stop condition | | | |
| 1 to 10000 | Counter for current statistics cycle | | | |
| NONE | No counting mode set | NONE | – | |
| Description of command | | | | |
| This command is always a query. It returns the status of the measurement (see chapters 3 and 5) and the number of the current statistics cycle. | | | | |

| CONFigure:AFANalyzer[:PRIMary]:MTReduce <Mode>, <Frequency> CONFigure:AFANalyzer:SECOndary:MTReduce | | Reduce Measurement Time | | |
|---|---|-------------------------|-----------|----------|
| <Mode> | Description of parameters | Def. value | Def. unit | FW vers. |
| LOWF | Measurement time according to lowest frequency (10 kHz) | LOWF | – | |
| EXPF | Measurement time according to <Frequency> | | | |
| <Frequency> | Description of parameters | Def. value | Def. unit | FW vers. |
| 10 Hz to 21 kHz | Expected frequency of the audio input signal | 100 | Hz | V3.00 |
| Description of command | | | | |
| This command is to reduce the measurement time the audio analyzer uses to calculate the measurement results (<Mode>=EXPF); see section Subsystem AFANalyzer... (Measured Values) on page 6.115. The measurement time must be adapted to the period of the input signal, which is the reverse of the frequency. Therefore, the audio measurement can be accelerated for high-frequency signals. In the LOWF mode, <Frequency> is not taken into account. | | | | |

Subsystem AFANalyzer...:CONTRol (Control)

The subsystem *AFANalyzer...:CONTRol* defines the scope of the audio analysis and sets the reference frequency for the distortion measurement. The settings are provided in the *Control* and *Distortion* tabs of the *Analyzer Configuration* popup menu.

| CONFigure:AFANalyzer[:PRIMary]:CONTRol:REPetition CONFigure:AFANalyzer:SECOndary:CONTRol:REPetition <Repetition>, <StopCondition>, <Stepmode> | | | | Test Cycles |
|---|--|------------|-----------|-------------|
| <Repetition> | Description of parameters | Def. value | Def. unit | |
| CONTInuous SINGleshot 1 to 10000 | Continuous measurement (until STOP or ABORT) Single shot measurement (until Status = RDY) Multiple measurement (counting, until Status = STEP RDY) | SING | – | |
| <StopCondition> | Description of parameters | Def. value | Def. unit | |
| NONE | Continue measurement even in case of error | NONE | – | |
| <Stepmode> | Description of parameters | Def. value | Def. unit | FW vers. |
| STEP NONE | Interrupt measurement after each statistic cycle Continue measurement according to its rep. mode | NONE | – | V2.10 |
| Description of command | | | | |
| This command determines the number of statistics cycles and the stepping mode for the measurement. A stop condition is not available. | | | | |
| Note: For READ commands (READ:...) the <Repetition> parameter has no effect; the measurement is always stopped after a single shot. | | | | |

| CONFigure:AFANalyzer[:PRIMary]:CONTRol:DISTRortion[:FREQUency] <Frequency> CONFigure:AFANalyzer:SECOndary:CONTRol:DISTRortion[:FREQUency] <Frequency> | | | | Frequency |
|--|--|------------|-----------|-----------|
| <Frequency> | Description of parameters | Def. value | Def. unit | FW vers. |
| 20 Hz to 21000 Hz | Reference frequency for distortion measurement | 1000 | Hz | V2.10 |
| Description of command | | | | |
| This command determines the reference frequency for the harmonic distortion measurement. | | | | |

| CONFigure:AFANalyzer[:PRIMary]:CONTRol:COUPling <Coupling> CONFigure:AFANalyzer:SECOndary:CONTRol:COUPling <Coupling> | | | | AF Path Coupling |
|---|--|---|-----------|------------------|
| <Coupling> | Description of parameters | Def. value | Def. unit | FW vers. |
| AC DC | AC coupling of AF path DC coupling of AF path | AC ([: PRIMary] channel) DC (: SECOndary channel) | – | V3.05 |
| Description of command | | | | |
| These commands determine the AF path coupling for measurements using the AF analyzer. In firmware versions <3.05, the commands are replaced by two equivalent CONFigure: . . . COUPling commands. | | | | |

Subsystem AFANalyzer...:FILTer (Filter)

The subsystem *AFANalyzer:...:FILTer* configures the input path of the AF analyzer. The subsystem corresponds to the *Filter* tab in the *Analyzer Configuration* menu. The input path of the AF analyzer is as shown below:

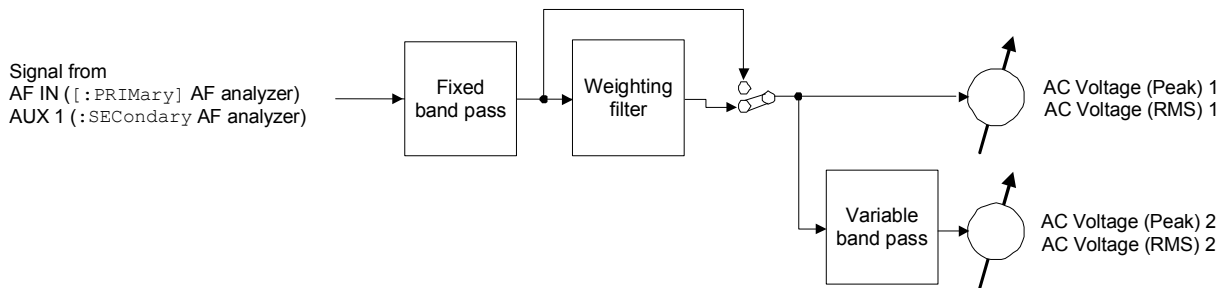

Fig. 6-1 AF analyzer input path configuration

| CONFigure:AFANalyzer[:PRIMary]:FILTer:VBPass:CFrequency <Center> | | | | Frequency |
|---|-------------------------------|------------|-----------|-----------|
| CONFigure:AFANalyzer:SECOndary:FILTer:VBPass:CFrequency <Center> | | | | |
| <Center> | Description of parameters | Def. value | Def. unit | FW vers. |
| 20 Hz to 21000 Hz | Center frequency of band pass | 1000 | Hz | V2.12 |
| Description of command | | | | |
| This command determines the center frequency of the variable band pass. | | | | |

| CONFigure:AFANalyzer[:PRIMary]:FILTer:VBPass:BWIDth <Bandwidth> | | | | Bandwidth |
|--|---------------------------|------------|-----------|-----------|
| CONFigure:AFANalyzer:SECOndary:FILTer:VBPass:BWIDth <Bandwidth> | | | | |
| <Bandwidth> | Description of parameters | Def. value | Def. unit | FW vers. |
| 10 Hz to 1000 Hz | Bandwidth of band pass | 200 | Hz | V2.12 |
| Description of command | | | | |
| This command determines the bandwidth of the variable band pass filter. | | | | |

| CONFigure:AFANalyzer[:PRIMary]:FILTer:WEIGHting <Weighting> | | | | Weighting Filter |
|--|-------------------------------------|------------|-----------|------------------|
| CONFigure:AFANalyzer:SECOndary:FILTer:WEIGHting <Weighting> | | | | |
| <Weighting> | Description of parameters | Def. value | Def. unit | FW vers. |
| A | Switch on A-weighted filter | OFF | – | V4.23 |
| CME | Switch on C-message weighted filter | | | V2.12 |
| CCI | Switch on CCITT weighting filter | | | |
| OFF | No weighting filter | | | |
| Description of command | | | | |
| This command selects the weighting filter after the fixed band pass (see Fig. 6-1). | | | | |

| | | Bandwidth (AC Coup.) | | |
|--|--|----------------------|-----------|----------|
| CONFigure:AFANalyzer[:PRIMary]:FILTer:BPASs:ACCoupling <Band pass> | | | | |
| CONFigure:AFANalyzer:SECONdary:FILTer:BPASs:ACCoupling <Band pass> | | | | |
| <Band pass> | Description of parameters | Def. value | Def. unit | FW vers. |
| | R&S CMU band pass filter with a bandwidth of | BP16 | – | V3.05 |
| BP01 | 0 Hz to 250 Hz | | | |
| BP02 | 6 Hz to 250 Hz | | | |
| BP03 | 50 Hz to 250 Hz | | | |
| BP04 | 0 Hz to 3000 Hz | | | |
| BP05 | 6 Hz to 3000 Hz | | | |
| BP06 | 50 Hz to 3000 Hz | | | |
| BP07 | 300 Hz to 3000 Hz | | | |
| BP08 | 0 Hz to 4000 Hz | | | |
| BP09 | 6 Hz to 4000 Hz | | | |
| BP10 | 50 Hz to 4000 Hz | | | |
| BP11 | 300 Hz to 4000 Hz | | | |
| BP12 | 0 Hz to 15000 Hz | | | |
| BP13 | 6 Hz to 15000 Hz | | | |
| BP14 | 50 Hz to 15000 Hz | | | |
| BP15 | 300 Hz to 15000 Hz | | | |
| BP16 | 0 Hz to 21000 Hz | | | |
| BP17 | 6 Hz to 21000 Hz | | | |
| BP18 | 50 Hz to 21000 Hz | | | |
| BP19 | 500 Hz to 5000 Hz | | | V4.23 |
| Description of command | | | | |
| This command selects the first band pass in the AF analyzer to be used if the AF path coupling is set to AC (see CONFigure:AFANalyzer...:COUPling command). | | | | |
| Note: In firmware versions ≥V2.12 but <V3.05, the CONFigure:AFANalyzer...:FILTer:BPASs commands replace the CONFigure:AFANalyzer...:FILTer:BPASs:ACCoupling and CONFigure:AFANalyzer...:FILTer:BPASs:DCCoupling commands. No distinction is made between AC and DC path coupling. | | | | |

| Bandwidth (DC Coup.) | | | | |
|---|--|------------|-----------|----------|
| CONFigure:AFANalyzer[:PRIMary]:FILTer:BPASs:DCCoupling <Band pass> | | | | |
| CONFigure:AFANalyzer:SECONdary:FILTer:BPASs:DCCoupling <Band pass> | | | | |
| <Band pass> | Description of parameters | Def. value | Def. unit | FW vers. |
| | R&S CMU band pass filter with a bandwidth of | BP17 | – | V3.05 |
| BP02 | 6 Hz to 250 Hz | | | |
| BP03 | 50 Hz to 250 Hz | | | |
| BP05 | 6 Hz to 3000 Hz | | | |
| BP06 | 50 Hz to 3000 Hz | | | |
| BP07 | 300 Hz to 3000 Hz | | | |
| BP09 | 6 Hz to 4000 Hz | | | |
| BP10 | 50 Hz to 4000 Hz | | | |
| BP11 | 300 Hz to 4000 Hz | | | |
| BP13 | 6 Hz to 15000 Hz | | | |
| BP14 | 50 Hz to 15000 Hz | | | |
| BP15 | 300 Hz to 15000 Hz | | | |
| BP17 | 6 Hz to 21000 Hz | | | |
| BP18 | 50 Hz to 21000 Hz | | | |
| BP19 | 500 Hz to 5000 Hz | | | V4.23 |
| Description of command | | | | |
| This command selects the first band pass in the AF analyzer to be used if the AF path coupling is set to DC (see CONFigure:AFANalyzer...:COUPling command). | | | | |
| Note: In firmware versions $\geq V2.12$ but $< V3.05$, the CONFigure:AFANalyzer...:FILTer:BPASs commands replace the CONFigure:AFANalyzer...:FILTer:BPASs:ACCOupling and CONFigure:AFANalyzer...:FILTer:BPASs:DCCoupling commands. No distinction is made between AC and DC path coupling. In firmware V3.00, no band pass selection is possible if DC path coupling is set. The CMU always uses a default band pass with a bandwidth of 6 Hz to 21000 Hz (BP17). | | | | |

Subsystem AFANalyzer... (Measured Values)

The subsystem *AFANalyzer...* starts the audio analysis and returns the results.

| READ[:SCALar]:AFANalyzer[:PRIMary]? READ[:SCALar]:AFANalyzer:SECOndary? FETCh[:SCALar]:AFANalyzer[:PRIMary]? FETCh[:SCALar]:AFANalyzer:SECOndary? | | Scalar Results | | |
|--|--|--|------------------|----------|
| | | Start single shot meas. and return results | | |
| | | Read out meas. results (unsynchronized) | | |
| Return | Description of parameters | Def. value | Def. unit | FW vers. |
| PeakVoltage1, RMSVoltage1, DCVoltage, THD + N, | 0 V to 42.4 V 0 V to 30 V –30 V to 30 V 0 % to 100% | NAN NAN NAN NAN | V V V % | V2.12 |
| PeakVoltage2, RMSVoltage2, | 0 V to 42.4 V 0 V to 30 V | NAN NAN | V V | V2.13 |
| Frequency, SINAD, THD | 10 Hz to 204.8 kHz – 0 % to 100% | NAN NAN NAN | Hz dB % | V4.23 |
| Description of command | | | | |
| These commands are always queries. They start a measurement and output all scalar measurement results (see also Fig. 6-1). These are: | | | | |
| <ul style="list-style-type: none"> • Peak1 and RMS1 value of AC voltage after first band pass and the weighting filter • DC voltage • Total harmonic distortion and noise (THD + N) • Peak2 and RMS2 value of AC voltage after first band pass and second band pass (variable band pass) • Frequency counter • Signal-to-Noise-and-Distortion ratio (SINAD) • Total harmonic distortion (THD) | | | | |

AF Generator (AFGenerator)

The subsystem *AFGenerator* configures and controls the AF generator. It corresponds to the measurement softkey *Generator* in the measurement menu *Audio Analyzer/Generator* and the associated input fields.

| INITiate:AFGenerator[:PRIMary] INITiate:AFGenerator:SECOndary ABORT:AFGenerator[:PRIMary] ABORT:AFGenerator:SECOndary | | AF Generator Control | |
|--|--|----------------------|------------|
| | Start AF generator, reserve resources | ⇒ | <i>RUN</i> |
| | Switch off AF generator, release resources | ⇒ | <i>OFF</i> |
| Description of command | | | FW vers. |
| These commands have no query form. They start and stop the AF generator, setting it to the status given in the top right column. | | | V2.10 |
| Note: | <i>A running multitone measurement must be aborted before the single tone AF generator is switched on. See note in section Audio Generator and Analyzer on page 6.107.</i> | | |

| FETCh:AFGenerator[:PRIMary]:STATus? FETCh:AFGenerator:SECondary:STATus? | | Generator Status | | |
|--|--|------------------|-----------|----------|
| Return | Description of parameters | Def. value | Def. unit | FW vers. |
| OFF | Generator switched off (ABORT, *RST or OFF due to conflict of resources) | OFF | – | V2.10 |
| RUN | Running (INITiate) | | | |
| ERR | Switched off (could not be started) | | | |
| Description of command | | | | |
| This command is always a query. It returns the current generator status. | | | | |

| SOURce:AFGenerator[:PRIMary]:LEVel <Level> SOURce:AFGenerator:SECondary:LEVel <Level> | | Generator Level | | |
|---|---------------------------|-----------------|-----------|----------|
| <Level> | Description of parameters | Def. value | Def. unit | FW vers. |
| 0.01 mV to 5.0 V | AF generator voltage | 1 | V | V2.10 |
| Description of command | | | | |
| This command defines the RMS voltage of the generated AC audio signal or the constant DC voltage, depending on the selected signal type (see command SOURce:AFGenerator...SMODE). Use ABORT:AFGenerator... to turn off the AF generator entirely. | | | | |

| SOURce:AFGenerator[:PRIMary]:FREQuency <Frequency> SOURce:AFGenerator:SECondary:FREQuency <Frequency> | | Frequency | | |
|--|---------------------------|------------|-----------|----------|
| <Frequency> | Description of parameters | Def. value | Def. unit | FW vers. |
| 20 Hz to 21 kHz | AF-Generator frequency | 1000 | Hz | V2.10 |
| Description of command | | | | |
| This command determines the AF generator frequency. | | | | |

| SOURce:AFGenerator[:PRIMary]:SMODE <Signal> SOURce:AFGenerator:SECondary:SMODE <Signal> | | Generator Signal | | |
|--|---------------------------|------------------|-----------|----------|
| <Frequency> | Description of parameters | Def. value | Def. unit | FW vers. |
| AC DC | AF generator signal type | AC | – | V3.10 |
| Description of command | | | | |
| This command determines whether the AF generator signal is an AC or DC signal. | | | | |

Multitone Measurement (MULTitone)

The subsystem *MULTitone* measures the level of an audio test signal comprising up to 20 test tones. The subsystem corresponds to the measurement menu *Multitone* and the associated popup menu *Multitone Configuration*.

In analogy to the *AFGenerator* and *AFAnalyzer* subsystems reported above, the *Multitone* measurement provides two independent circuits:

- In the first audio channel (subsystem `MULTitone:AF1Channel...`), the audio signals are applied to the connectors AF OUT (output, AF generator signal) and AF IN (input) on the R&S CMU front panel. The first audio channel corresponds to the *Multitone* menu, application *AF Chan. One*, and the associated configuration menu.
- In the second audio channel (subsystem `MULTitone:AF2Channel...`), the audio signals are applied to the connectors AUX 2 (output, AF generator signal) and AUX 1 (input) on the R&S CMU front panel. The second audio channel corresponds to the *Multitone* menu, application *AF Chan. Two*, and the associated configuration menu.

With the exception of the input and output connectors, the two audio circuits are identical. All remote control commands are analogous.

The *Stereo* application is a combination of the previous two applications, where the R&S generates and analyzes two audio signals at equal or different frequencies. The stereo commands are reported in section [MULTitone:STEReo Subsystem](#) on p. 6.129 .

Single-Tone Measurement (MULTitone:AF<n>Channel)

The commands in the following sections control the multitone measurement in the first and second audio channel.

Measurement Control – Subsystem MULTitone

The subsystem *MULTitone* controls the measurement. It corresponds to the softkey *AF Chan. One* in the measurement menu *Multitone* and some of the associated hotkeys.

| | | |
|---|---|---------------|
| INITiate:MULTitone:AF1Channel | Start new measurement | ⇒ <i>RUN</i> |
| INITiate:MULTitone:AF2Channel | | |
| ABORt:MULTitone:AF1Channel | Abort running measurement and switch off | ⇒ <i>OFF</i> |
| ABORt:MULTitone:AF2Channel | | |
| STOP:MULTitone:AF1Channel | Stop measurement after current stat. cycle | ⇒ <i>STOP</i> |
| STOP:MULTitone:AF2Channel | | |
| CONTinue:MULTitone:AF1Channel | Next measurement step (only <i>stepping mode</i>) | ⇒ <i>RUN</i> |
| CONTinue:MULTitone:AF2Channel | | |
| Description of command | | FW vers. |
| These commands have no query form. They start and stop the measurement, setting it to the status indicated in the top right column. | | V3.00 |
| Note: | <i>The single tone AF generator must be switched off before a multitone measurement is started. See note in section Audio Generator and Analyzer on p. 6.107.</i> | |

| CONFigure:MULTitone:AF1Channel:EREPorting <Mode> | | Event Reporting | | |
|--|---------------------------|-----------------|-----------|----------|
| CONFigure:MULTitone:AF2Channel:EREPorting <Mode> | | | | |
| <Mode> | Description of parameters | Def. value | Def. unit | FW vers. |
| SRQ | Service request | OFF | – | V3.00 |
| SOPC | Single operation complete | | | |
| SRSQ | SRQ and SOPC | | | |
| OFF | No reporting | | | |
| Description of command | | | | |
| This command defines the events generated when the measurement is terminated or stopped (<i>event reporting</i> , see chapter 5). | | | | |

| FETCh:MULTitone:AF1Channel:STATus? | | Measurement Status | | |
|--|---|--------------------|-----------|----------|
| FETCh:MULTitone:AF2Channel:STATus? | | | | |
| Ret. values | Description of parameters | Def. value | Def. unit | FW vers. |
| OFF | Measurement in the <i>OFF</i> state (*RST or ABORT) | OFF | – | V3.00 |
| RUN | Running (after INITiate, CONTinue or READ) | | | |
| STOP | Stopped (STOP) | | | |
| ERR | OFF (could not be started) | | | |
| STEP | Stepping mode (<stepmode>=STEP) | | | |
| RDY, | Stopped according to repetition mode and stop condition | | | |
| 1 to 10000 | Counter for current statistics cycle | | | |
| NONE | No counting mode set | NONE | – | |
| Description of command | | | | |
| This command is always a query. It returns the status of the measurement (see chapters 3 and 5). | | | | |

| DISPlay:MULTitone:AF1Channel:GRID <Enable> | | Grid on/off | | |
|--|---------------------------|-------------|-----------|----------|
| DISPlay:MULTitone:AF2Channel:GRID <Enable> | | | | |
| <Enable> | Description of parameters | Def. value | Def. unit | FW vers. |
| ON | Switch on grid lines | ON | – | V3.00 |
| OFF | Switch off grid lines | | | |
| Description of command | | | | |
| This command switches the grid lines in the test diagrams on or off. | | | | |

| CONFigure:MULTitone:AF1Channel:COUPling <Coupling> | | Path Coupling (AF IN) | | |
|--|---------------------------|-----------------------|-----------|----------|
| CONFigure:MULTitone:AF2Channel:COUPling <Coupling> | | | | |
| <Coupling> | Description of parameters | Def. value | Def. unit | FW vers. |
| AC | AC coupling of AF path | AC (:AF1Channel) | – | V3.05 |
| DC | DC coupling of AF path | DC (:AF2Channel) | | |
| Description of command | | | | |
| This command determines the AF path coupling for multitone measurements. | | | | |

| CONFigure:MULTitone:AF1Channel:RLEVel <Voltage> | | AF Reference Level | | |
|--|---------------------------|--------------------|-----------|----------|
| CONFigure:MULTitone:AF2Channel:RLEVel <Voltage> | | | | |
| <Voltage> | Description of parameters | Def. value | Def. unit | FW vers. |
| 0.001 V to 5.000 V | Reference Level | 0.010 | V | V3.00 |
| Description of command | | | | |
| This command defines the AF reference level, i.e. the 0-dB line in the test diagram. | | | | |

| CONFigure:MULTitone:AF1Channel:RMODe <Reference> CONFigure:MULTitone:AF2Channel:RMODe <Reference> | | | | Result |
|--|---|------------|-----------|----------|
| <Reference> | Description of parameters | Def. value | Def. unit | FW vers. |
| RLEV TON<nr> | Results relative to the reference level Results relative to level at test tone <nr>, where <nr> = 1 to 20 | TON4 | – | V3.00 |
| Description of command | | | | |
| This command defines the reference value for the results of the <i>Multitone</i> measurement. The reference level is defined via CONFigure:MULTitone:AF1Channel:RLEVel. To choose one of the test tones no. 1 to 20, it must be enabled via the CONFigure:MULTitone:AF1Channel:TDEFinition:TONE<nr> command. | | | | |

| CONFigure:MULTitone:AF1Channel:AFGLead <Time> CONFigure:MULTitone:AF2Channel:AFGLead <Time> | | | | AF Generator Lead |
|--|---------------------------|------------|-----------|-------------------|
| <Time> | Description of parameters | Def. value | Def. unit | FW vers. |
| 0 s to 0.1 s | Hold off time | 0.014 | s | V3.00 |
| Description of command | | | | |
| This command defines a hold off time for the AF generator. | | | | |

Test Configuration

The commands of the following subsystems configure the *Multitone* measurement. They correspond to the *Multitone Configuration* menu.

Subsystem MULTitone:...CONTrol

The subsystem *MULTitone:...CONTrol* defines the scope of the measurement. It corresponds to the *Control* tab in the popup menu *Multitone Configuration*.

| CONFigure:MULTitone:AF1Channel:CONTrol:REPetition CONFigure:MULTitone:AF2Channel:CONTrol:REPetition <Repetition>, <StopCond>, <Stepmode> | | | | Test Cycles |
|--|---|------------|-----------|-------------|
| <Repetition> | Description of parameters | Def. value | Def. unit | |
| CONTinuous SINGleshot 1 to 10000, | Continuous measurement (until STOP or ABORT) Single shot measurement (until Status = RDY) Multiple measurement (counting, until Status = STEP RDY) | SING | – | |
| <StopCond> | Description of parameters | Def. value | Def. unit | |
| SONerror NONE, | Stop measurement in case of error (<i>stop on error</i>) Continue measurement even in case of error | NONE | – | |

| <Stepmode> | Description of parameters | Def. value | Def. unit | FW vers. |
|---|---|------------|-----------|----------|
| STEP | Interrupt measurement after each statistics cycle | NONE | – | V3.00 |
| NONE | Continue measurement according to its rep. mode | | | |
| Description of command | | | | |
| This command determines the number of statistics cycles, the stop condition and the stepping mode for the measurement. | | | | |
| Note: For READ commands (READ:...), the <Repetition> parameter has no effect; the measurement is always stopped after a single shot. | | | | |

Subsystem SUBarrays:MULTitone:...

The subsystem SUBarrays:MULTitone:... defines the measurement range and the type of output values.

| CONFigure:SUBarrays:MULTitone:AF1Channel | | Definition of Subarrays | | |
|---|--|-------------------------|-----------|----------|
| CONFigure:SUBarrays:MULTitone:AF2Channel | | | | |
| <Mode>,<Start>,<Samples>{,<Start>,<Samples>} | | | | |
| <Mode> | Description of parameters | Def. value | Def. unit | FW vers. |
| ALL | Return all measurement values | ALL | – | V3.00 |
| ARITHmetical | Return arithm. mean value in every subrange | | | |
| MINimum | Return minimum value in every subrange | | | |
| MAXimum | Return maximum value in every subrange | | | |
| IVAL | Return single interpolated value at <Start> | | | |
| XMAXimum | Return x-axis value of maximum and maximum | | | |
| XMINimum | Return x-axis value of minimum and minimum | | | |
| PAVG, | Return arithmetic mean value in every subrange | | | V5.00 |
| <Start> | Description of parameters | Def. value | Def. unit | FW vers. |
| 1 to 20, | Start test tone in current range | 1 | – | |
| <Samples> | Description of parameters | Def. value | Def. unit | FW vers. |
| 1 to 20 | Number of test tones in current range | 20 | – | V3.00 |
| Description of command | | | | |
| This command configures the READ:SUBarrays:MULTitone:AF1Channel... and FETCh:SUBarrays:MULTitone:AF1Channel... commands. It restricts the measurement to up to 32 subranges where either all measurement results (the number of which is given by the <Samples> parameter) or a single statistical value is returned. | | | | |
| For <Mode> = IVAL, the <Samples> parameter is ignored and the R&S CMU returns a single measurement value corresponding to the abscissa value <Start>. If <Start> is located between two test points with valid results then the result is calculated from the results at these two adjacent test points by linear interpolation. | | | | |
| The subranges are subsets of the full range of test tones defined via CONFigure:MULTitone:AF1Channel:TONE<nr>. Each subrange contains all test tones between the start test tone (test tone no. <Start>) and test tone no. <Start> + <Samples> – 1. Test points inside this range that are disabled are not measured (result NAN) and do not enter into the ARITHmetical, MINimum and MAXimum values. | | | | |
| By default, only one range corresponding to the total measurement range is used and all measurement values are returned. | | | | |

Tolerance values – Subsystem MULTitone:...LIMit

The subsystem *MULTitone:...LIMit* defines tolerance values for the *Multitone* measurement. The subsystem corresponds to the *Limits* tab of the popup menu *Multitone Configuration*.

| CONFigure:MULTitone:AF1Channel:LIMit:LINE:ASYMmetric:UPPer | | | | | |
|---|--------------------------------------|-----------------------------|------------------------|------------------------|---------------|
| CONFigure:MULTitone:AF2Channel:LIMit:LINE:ASYMmetric:UPPer | | | | | |
| <Limit_1>, <Enable_1>, ... <Limit_20>, <Enable_20> | | Upper Limit, Overall | | | |
| <Limit_nr> | Description of parameters | Def. value | Def. unit | | |
| -80 dB to +80 dB, | Upper limit line at tone <nr> | See below | dB | | |
| <Enable_nr> | Description of parameters | Def. value | Def. unit | FW vers. | |
| ON OFF | Enable upper limit line at tone <nr> | ON | – | V3.00 | |
| Description of command | | | | | |
| This command configures the upper limit lines and enables the limit check at the 20 test tones that can be defined via <code>CONFigure:MULTitone:AF1Channel:TONE<nr></code> . | | | | | |
| By default, the limit check is switched on at all tones and the following limit lines apply: | | | | | |
| Tone <nr> | Limit Line/[dB] | Enable | Tone <nr> | Limit Line/[dB] | Enable |
| 1 | -9.5 | ON | 11 | +5.6 | ON |
| 2 | -6.2 | ON | 12 | +6.3 | ON |
| 3 | -3.8 | ON | 13 | +6.9 | ON |
| 4 | -1.9 | ON | 14 | +7.5 | ON |
| 5 | -0.3 | ON | 15 | +8.0 | ON |
| 6 | +1.0 | ON | 16 | +8.6 | ON |
| 7 | +2.1 | ON | 17 | +9.1 | ON |
| 8 | +3.1 | ON | 18 | +9.6 | ON |
| 9 | +4.0 | ON | 19 | +10.0 | ON |
| 10 | +4.8 | ON | 20 | +10.5 | ON |

| CONFigure:MULTitone:AF1Channel:TONE<nr>:LIMit:LINE:ASYMmetric:UPPer | | | | |
|---|--------------------------------------|----------------------------------|-----------|----------|
| CONFigure:MULTitone:AF2Channel:TONE<nr>:LIMit:LINE:ASYMmetric:UPPer | | | | |
| <Limit>, <Enable> | | Upper Limit, Single Point | | |
| <Limit> | Description of parameters | Def. value | Def. unit | |
| -80 dB to +80 dB, | Upper limit line at tone <nr> | See below | dB | |
| <Enable> | Description of parameters | Def. value | Def. unit | FW vers. |
| ON OFF | Enable upper limit line at tone <nr> | ON | – | V3.00 |
| Description of command | | | | |
| This command configures the upper limit and enables the limit check at one of 20 test tones that can be defined via <code>CONFigure:MULTitone:AF1Channel:TONE<nr></code> . The test tones are numbered by <nr> = 1 to 20. The default limits at all test points are quoted in the previous command. | | | | |

CONFigure:MULTitone:AF1Channel:LIMit:LINE:ASYMmetric:LOWER
CONFigure:MULTitone:AF2Channel:LIMit:LINE:ASYMmetric:LOWER
<Limit_1>, <Enable_1>, ... <Limit_20>, <Enable_20> Lower Limits, Overall

| <Limit_nr> | Description of parameters | Def. value | Def. unit | |
|-------------------|--------------------------------------|------------|-----------|----------|
| -80 dB to +80 dB, | Lower limit line at tone <nr> | See below | dB | |
| <Enable_nr> | Description of parameters | Def. value | Def. unit | FW vers. |
| ON OFF | Enable lower limit line at tone <nr> | ON | - | V3.00 |

Description of command

This command configures the lower limit lines and enables the limit check at the 20 test tones that can be defined via `CONFigure:MULTitone:AF1Channel:TONE<nr>`.

By default, the limit check is switched on at all tones and the following limit lines apply:

| Tone <nr> | Limit Line/[dB] | Enable | Tone <nr> | Limit Line/[dB] | Enable |
|-----------|-----------------|--------|-----------|-----------------|--------|
| 1 | -13.5 | ON | 11 | +1.6 | ON |
| 2 | -10.2 | ON | 12 | +2.3 | ON |
| 3 | -7.8 | ON | 13 | +2.9 | ON |
| 4 | -5.9 | ON | 14 | +3.5 | ON |
| 5 | -4.3 | ON | 15 | +4.0 | ON |
| 6 | -3.0 | ON | 16 | +4.6 | ON |
| 7 | -1.9 | ON | 17 | +5.0 | ON |
| 8 | -0.9 | ON | 18 | +5.0 | ON |
| 9 | 0.0 | ON | 19 | +5.0 | ON |
| 10 | +0.8 | ON | 20 | +5.0 | ON |

CONFigure:MULTitone:AF1Channel:TONE<nr>:LIMit:LINE:ASYMmetric:LOWER
CONFigure:MULTitone:AF2Channel:TONE<nr>:LIMit:LINE:ASYMmetric:LOWER
<Limit>, <Enable> Lower Limit, Single Point

| <Limit> | Description of parameters | Def. value | Def. unit | |
|-------------------|--------------------------------------|------------|-----------|----------|
| -80 dB to +80 dB, | Lower limit line at tone <nr> | See below | dB | |
| <Enable> | Description of parameters | Def. value | Def. unit | FW vers. |
| ON OFF | Enable lower limit line at tone <nr> | ON | - | V3.00 |

Description of command

This command configures the lower limit and enables the limit check at one of 20 test tones that can be defined via `CONFigure:MULTitone:AF1Channel:TONE<nr>`. The test tones are numbered by <nr> = 1 to 20. The default limits at all test points are quoted in the previous command.

DEFault:MULTitone:AF1Channel:LIMit:LINE <Enable>
DEFault:MULTitone:AF2Channel:LIMit:LINE <Enable> Default Settings

| <Enable> | Description of parameters | Def. value | Def. unit | FW vers. |
|----------|---|------------|-----------|----------|
| ON OFF | The parameters are set to their default values Some or all parameters differ from the default values | ON | - | V3.00 |

Description of command

If used as a setting command with the parameter *ON* this command sets all parameters of the subsystem to their default values (the setting *OFF* results in an error message).

If used as a query the command returns whether all parameters are set to their default values (*ON*) or not (*OFF*).

| DEFault:MULTitone:LIMit:LINE <Enable> | | Default Settings | | |
|--|---|------------------|-----------|----------|
| <Enable> | Description of parameters | Def. value | Def. unit | FW vers. |
| ON OFF | The parameters are set to their default values | ON | – | V3.00 |
| | Some or all parameters differ from the default values | | | |
| Description of command | | | | |
| If used as a setting command with the parameter ON this command sets all parameters of the subsystem (including AF1Channel and AF2Channel) to their default values (the setting OFF results in an error message). If used as a query the command returns whether all parameters are set to their default values (ON) or not (OFF). | | | | |

Test Tones – Subsystem MULTitone:...TDEFinition

The subsystem *MULTitone:...TDEFinition* configures the audio test signal used for the *Multitone* measurement. The subsystem corresponds to the *Tone Def.* tab of the popup menu *Multitone Configuration*.

| CONFigure:MULTitone:AF1Channel:TDEFinition | | Test Tones | | | | | |
|--|--------------------------------|------------|-----------|-----------|----------------|-----------|--------|
| CONFigure:MULTitone:AF2Channel:TDEFinition | | | | | | | |
| <Freq_1>, <Lev_1>, <Enable_1>, ... <Freq_20>, <Lev_20>, <Enable_20> | | | | | | | |
| <Freq_nr> | Description of parameters | Def. value | Def. unit | | | | |
| 10 Hz to 16000 Hz, | Frequency of test tone <nr> | See below | Hz | | | | |
| <Lev_nr> | Description of parameters | Def. value | Def. unit | | | | |
| 0.0 V to 5.0 V ^{*)} , | Level at test tone <nr> | See below | V | | | | |
| <Enable_nr> | Description of parameters | Def. value | Def. unit | FW vers. | | | |
| ON OFF | Switch on / off test tone <nr> | See below | – | V3.00 | | | |
| Description of command | | | | | | | |
| This command enables and configures up to 20 test tones. The minimum frequency spacing between two tones is 1 Hz. The sum of all test tones must not exceed the maximum AF generator level quoted in the data sheet. | | | | | | | |
| *) The sum of the levels of all enabled tones must not exceed 5.0 V. | | | | | | | |
| The following default test tones are provided: | | | | | | | |
| Tone <nr> | Frequency/[Hz] | Level/[V] | Enable | Tone <nr> | Frequency/[Hz] | Level/[V] | Enable |
| 1 | 300 | 0.01 | ON | 11 | 1700 | 0.01 | ON |
| 2 | 440 | 0.01 | ON | 12 | 1840 | 0.01 | ON |
| 3 | 580 | 0.01 | ON | 13 | 1980 | 0.01 | ON |
| 4 | 720 | 0.01 | ON | 14 | 2120 | 0.01 | ON |
| 5 | 860 | 0.01 | ON | 15 | 2260 | 0.01 | ON |
| 6 | 1004 | 0.01 | ON | 16 | 2400 | 0.01 | ON |
| 7 | 1140 | 0.01 | ON | 17 | 2540 | 0.01 | ON |
| 8 | 1280 | 0.01 | ON | 18 | 2680 | 0.01 | ON |
| 9 | 1420 | 0.01 | ON | 19 | 2820 | 0.01 | ON |
| 10 | 1560 | 0.01 | ON | 20 | 3000 | 0.01 | ON |
| Note: If the level of all test tones is derived from a total level (TLEVel setting in the CONFigure:MULTitone:AF1Channel:TDEFinition:MODE command), the individual level settings are ignored. The <Frequency> and <Enable> parameter settings are still effective. | | | | | | | |

| CONFigure:MULTitone:AF1Channel:TDEFinition:TONE<nr> CONFigure:MULTitone:AF2Channel:TDEFinition:TONE<nr> <Frequency>, <Level>, <Enable> | | | | Test Tones |
|---|--------------------------------|------------|-----------|------------|
| <Frequency> | Description of parameters | Def. value | Def. unit | |
| 10 Hz to 16000 Hz, | Frequency of test tone <nr> | See below | Hz | |
| <Level> | Description of parameters | Def. value | Def. unit | |
| 0.0 V to 5.0 V ^{*)} , | AF level test tone <nr> | See below | V | |
| <Enable> | Description of parameters | Def. value | Def. unit | FW vers. |
| ON OFF | Switch on / off test tone <nr> | See below | – | V3.00 |
| Description of command | | | | |
| This command enables and configures one of up to 20 test tones (<nr> = 1 to 20). The default values for all test tones are given in the previous command. | | | | |
| *) The sum of the levels of all enabled tones must not exceed 5.0 V. | | | | |
| Note: If the level of all test tones is derived from a total level (TLEVel setting in the CONFigure:MULTitone:AF1Channel:TDEFinition:MODE command), the <Level> setting is ignored. The <Frequency> and <Enable> parameter setting is still effective. | | | | |

| CONFigure:MULTitone:AF1Channel:TDEFinition:MODE <Mode> CONFigure:MULTitone:AF2Channel:TDEFinition:MODE <Mode> | | | | Level Selection |
|--|-----------------------------------|------------|-----------|-----------------|
| <Mode> | Description of parameters | Def. value | Def. unit | FW vers. |
| SEParate | Use separate levels for each tone | SEParate | – | V3.00 |
| TLEVel | Use total level | | | |
| Description of command | | | | |
| This command defines how the voltage of each of the test tones is determined. | | | | |
| <ul style="list-style-type: none"> In the default setting SEParate, the levels of all tones are defined separately and may differ from each other (see command CONFigure:MULTitone:...:TDEFinition above). In the setting TLEV, the total AF generator level set via CONFigure:MULTitone:...:TDEFinition:TLEVel is evenly distributed among all enabled test tones. Test tones can still be enabled or disabled and their frequency can be changed (see CONF:MULT:...TDEF... commands above), but level settings will be ignored as long as TLEV remains effective. | | | | |

| CONFigure:MULTitone:AF1Channel:TDEFinition:TLEVel <Total_Level> CONFigure:MULTitone:AF2Channel:TDEFinition:TLEVel <Total_Level> | | | | Total Level |
|---|---|------------|-----------|-------------|
| <Total_Level> | Description of parameters | Def. value | Def. unit | FW vers. |
| 0.019 mV to 5.0 V | Total level/voltage (sum of all test tones) | 0.200 | V | V3.00 |
| Description of command | | | | |
| This command defines the total AF generator level that is evenly distributed among all enabled test tones. The total level setting comes into effect after the level selection mode is set to TLEV (see CONFigure:MULTitone:...:TDEFinition:MODE command above). The total level must not exceed the maximum AF generator level quoted in the data sheet. | | | | |

| DEFault:MULTitone:AF1Channel:TDEFinition <Enable> | | | | Default Settings | |
|---|---|------------|-----------|------------------|--|
| DEFault:MULTitone:AF2Channel:TDEFinition <Enable> | | | | | |
| <Enable> | Description of parameters | Def. value | Def. unit | FW vers. | |
| ON | The parameters are set to their default values | ON | – | V3.00 | |
| OFF | Some or all parameters differ from the default values | | | | |
| Description of command | | | | | |
| If used as a setting command with the parameter ON this command sets all parameters of the subsystem to their default values (the setting OFF results in an error message). | | | | | |
| If used as a query the command returns whether all parameters are set to their default values (ON) or not (OFF). | | | | | |

| DEFault:MULTitone:TDEFinition <Enable> | | | | Default Settings | |
|---|---|------------|-----------|------------------|--|
| <Enable> | Description of parameters | Def. value | Def. unit | FW vers. | |
| ON | The parameters are set to their default values | ON | – | V3.00 | |
| OFF | Some or all parameters differ from the default values | | | | |
| Description of command | | | | | |
| If used as a setting command with the parameter ON this command sets all parameters of the subsystem (including AF1Channel and AF2Channel) to their default values (the setting OFF results in an error message). | | | | | |
| If used as a query the command returns whether all parameters are set to their default values (ON) or not (OFF). | | | | | |

Path Configuration – Subsystem MULTitone:AF1Channel:FILTer

The subsystem *MULTitone:AF1Channel:FILTer* configures the voice-processing equipment used for the *Multitone* measurement. The subsystem corresponds to the *Filters* tab of the popup menu *Multitone Configuration*.

| CONFigure:MULTitone:AF1Channel:FILTer:BPASSs:DCCoupling | | | | Band Pass, DC Coupling | |
|--|--|------------|-----------|------------------------|--|
| CONFigure:MULTitone:AF2Channel:FILTer:BPASSs:DCCoupling | | | | | |
| <Bandpass> | | | | | |
| <Bandpass> | Description of parameters | Def. value | Def. unit | FW vers. | |
| | R&S CMU band pass filter with a bandwidth of | BP17 | – | V3.00 | |
| BP02 | 6 Hz to 250 Hz | | | | |
| BP03 | 50 Hz to 250 Hz | | | | |
| BP05 | 6 Hz to 3000 Hz | | | | |
| BP06 | 50 Hz to 3000 Hz | | | | |
| BP07 | 300 Hz to 3000 Hz | | | | |
| BP09 | 6 Hz to 4000 Hz | | | | |
| BP10 | 50 Hz to 4000 Hz | | | | |
| BP11 | 300 Hz to 4000 Hz | | | | |
| BP13 | 6 Hz to 15000 Hz | | | | |
| BP14 | 50 Hz to 15000 Hz | | | | |
| BP15 | 300 Hz to 15000 Hz | | | | |
| BP17 | 6 Hz to 21000 Hz | | | | |
| BP18 | 50 Hz to 21000 Hz | | | | |
| BP19 | 500 Hz to 5000 Hz | | | V4.23 | |
| Description of command | | | | | |
| This command selects the band pass filter to be used if the AF path coupling is set to DC (see CONFigure:AFANalyzer[:PRIMary]:COUpling command). | | | | | |

| CONFigure:MULTitone:AF1Channel:FILTER:BPASs:ACCoupling | | Band Pass, AC Coupling | | |
|---|--|------------------------|-----------|----------|
| CONFigure:MULTitone:AF2Channel:FILTER:BPASs:ACCoupling | | | | |
| <Bandpass> | | | | |
| <Bandpass> | Description of parameters | Def. value | Def. unit | FW vers. |
| | R&S CMU band pass filter with a bandwidth of | BP16 | – | V3.00 |
| BP01 | 0 Hz to 250 Hz | | | |
| BP02 | 6 Hz to 250 Hz | | | |
| BP03 | 50 Hz to 250 Hz | | | |
| BP04 | 0 Hz to 3000 Hz | | | |
| BP05 | 6 Hz to 3000 Hz | | | |
| BP06 | 50 Hz to 3000 Hz | | | |
| BP07 | 300 Hz to 3000 Hz | | | |
| BP08 | 0 Hz to 4000 Hz | | | |
| BP09 | 6 Hz to 4000 Hz | | | |
| BP10 | 50 Hz to 4000 Hz | | | |
| BP11 | 300 Hz to 4000 Hz | | | |
| BP12 | 0 Hz to 15000 Hz | | | |
| BP13 | 6 Hz to 15000 Hz | | | |
| BP14 | 50 Hz to 15000 Hz | | | |
| BP15 | 300 Hz to 15000 Hz | | | |
| BP16 | 0 Hz to 21000 Hz | | | |
| BP17 | 6 Hz to 21000 Hz | | | |
| BP 18 | 50 Hz to 21000 Hz | | | |
| BP19 | 500 Hz to 5000 Hz | | | V4.23 |
| Description of command | | | | |
| This command selects the band pass filter to be used if the AF path coupling is set to AC (see <code>CONFigure:AFAnalyzer[:PRIMary]:COUpling</code> command). | | | | |

| CONFigure:MULTitone:AF1Channel:FILTER:WEIGHTing <Weighting> | | Weighting | | |
|---|-------------------------------------|------------|-----------|----------|
| CONFigure:MULTitone:AF2Channel:FILTER:WEIGHTing <Weighting> | | | | |
| <Weighting> | Description of parameters | Def. value | Def. unit | FW vers. |
| A | Switch on A-weighted filter | OFF | – | V4.23 |
| CME | Switch on C-message weighted filter | | | V3.00 |
| CCI | Switch on CCITT weighting filter | | | |
| OFF | No weighting filter | | | |
| Description of command | | | | |
| This command selects the weighting filter to be included in the AF input signal path. | | | | |

| DEFault:MULTitone:AF1Channel:FILTER <Enable> | | Default Settings | | |
|---|---|------------------|-----------|----------|
| DEFault:MULTitone:AF2Channel:FILTER <Enable> | | | | |
| <Enable> | Description of parameters | Def. value | Def. unit | FW vers. |
| ON | The parameters are set to their default values | ON | – | V3.00 |
| OFF | Some or all parameters differ from the default values | | | |
| Description of command | | | | |
| If used as a setting command with the parameter <i>ON</i> this command sets all parameters of the subsystem to their default values (the setting <i>OFF</i> results in an error message). | | | | |
| If used as a query the command returns whether all parameters are set to their default values (<i>ON</i>) or not (<i>OFF</i>). | | | | |

| DEFault:MULTitone:FILTer <Enable> | | Default Settings | | |
|--|---|------------------|-----------|----------|
| <Enable> | Description of parameters | Def. value | Def. unit | FW vers. |
| ON | The parameters are set to their default values | ON | – | V3.00 |
| OFF | Some or all parameters differ from the default values | | | |
| Description of command | | | | |
| If used as a setting command with the parameter <i>ON</i> this command sets all parameters of the subsystem (including <i>AF1Channel</i> and <i>AF2Channel</i>) to their default values (the setting <i>OFF</i> results in an error message). If used as a query the command returns whether all parameters are set to their default values (<i>ON</i>) or not (<i>OFF</i>). | | | | |

Results – Subsystem MULTitone:...?

The subsystem *MULTitone:...?* measures the AF input level, returns the results and compares them with the tolerance values. The subsystem corresponds to the various output elements in the measurement menu *Multitone*.

| READ[:SCALar]:MULTitone:AF1Channel:TONE<nr>? | | Multitone Results | | |
|---|---------------------------|--|-----------|----------|
| READ[:SCALar]:MULTitone:AF2Channel:TONE<nr>? | | Start single shot measurement and return results | | ⇒ RUN |
| FETCh[:SCALar]:MULTitone:AF1Channel:TONE<nr>? | | Read results (unsynchronized) | | ⇒ RUN |
| FETCh[:SCALar]:MULTitone:AF2Channel:TONE<nr>? | | | | |
| Returned values | Description of parameters | Def. value | Def. unit | FW vers. |
| –100.0 dB to +20.0 dB | AF response at point <nr> | NAN | dB | V3.00 |
| Description of command | | | | |
| These commands are always queries. They return the audio level at test tones <nr> (<nr> = 1 to 20) defined via <code>CONFigure:MULTitone:AF1Channel:TONE<nr></code> . | | | | |

| READ:ARRay:MULTitone:AF1Channel? | | Multitone Results | | |
|--|--|--|-----------|----------|
| READ:ARRay:MULTitone:AF2Channel? | | Start single shot measurement and return results | | ⇒ RUN |
| FETCh:ARRay:MULTitone:AF1Channel? | | Read meas. results (unsynchronized) | | ⇒ RUN |
| FETCh:ARRay:MULTitone:AF2Channel? | | | | |
| Returned values | Description of parameters | Def. value | Def. unit | FW vers. |
| –100.0 dB to +20.0 dB, | FreqResp[1], 1 st value for AF response | NAN | dB | V3.00 |
| ... | ... | ... | ... | |
| –100.0 dB to +20.0 dB | FreqResp[20], 20th value for AF resp. | NAN | dB | |
| Description of command | | | | |
| These commands are always queries. They return the audio level at the 20 test tones defined via <code>CONFigure:MULTitone:AF1Channel:TONE<nr></code> . | | | | |

| READ:SUBarrays:MULTitone:AF1Channel? | | Subarray Results | | |
|---|--|--|-----------|----------|
| | | Start single shot measurement and return results | ⇒ RUN | |
| READ:SUBarrays:MULTitone:AF2Channel? | | | | |
| FETCh:SUBarrays:MULTitone:AF1Channel? | | Read meas. results (unsynchronized) | ⇒ RUN | |
| FETCh:SUBarrays:MULTitone:AF2Channel? | | | | |
| Ret. values per subrange | Description of parameters | Def. value | Def. unit | FW vers. |
| -100.0 dB to +20.0 dB, | FreqResp[1], 1 st value for AF response | NAN | dB | V3.00 |
| ... | ... | ... | ... | |
| -100.0 dB to +20.0 dB | FreqResp[n], nth value for AF response | NAN | dB | |
| Description of command | | | | |
| <p>These commands are always queries. They return the audio level in the subranges defined by means of the <code>CONFigure:SUBarrays:MULTitone:AF1Channel</code> command. In the default setting of the configuration command the <code>READ:SUBarrays...</code> and <code>FETCh:SUBarrays...</code> command group is equivalent to the <code>READ:ARRay...</code> and <code>FETCh:ARRay...</code> command group described above.</p> <p>The <code>CONFigure:SUBarrays:MULTitone:AF1Channel</code> command defines a maximum of 32 subranges. If one of the statistical modes (<code>ARITHmetical</code>, <code>MINimum</code>, <code>MAXimum...</code>) or <code>IVAL</code> is set, only one value is returned by subrange.</p> | | | | |

| CALCulate[:SCALar]:MULTitone:AF1Channel:TONE<nr>:MATChing:LIMit? | | Limit Matching | | | | | | | | | | | | | | |
|--|------------------------------|--------------------------------|-----------|----------|------|------------------------------|--------------------------------|------|--------------------------|-------------------------------|-----|---------------------|----------------|----|------------------------|--|
| CALCulate[:SCALar]:MULTitone:AF2Channel:TONE<nr>:MATChing:LIMit? | | | | | | | | | | | | | | | | |
| Returned result | Value range | Def. value | Def. unit | FW vers. | | | | | | | | | | | | |
| Limit matching at tone <nr> | NMAU NMAL INV OK | INV | - | V3.00 | | | | | | | | | | | | |
| Description of command | | | | | | | | | | | | | | | | |
| <p>This command is always a query. It indicates whether and in which way the error limits at tone <nr> (<nr> = 1 to 20) have been exceeded.</p> <p>The following messages may be returned for test tone <nr>:</p> <table border="0"> <tr> <td>NMAU</td> <td>Underflow of tolerance value</td> <td><i>not matching, underflow</i></td> </tr> <tr> <td>NMAL</td> <td>Tolerance value exceeded</td> <td><i>not matching, overflow</i></td> </tr> <tr> <td>INV</td> <td>Measurement invalid</td> <td><i>invalid</i></td> </tr> <tr> <td>OK</td> <td>all tolerances matched</td> <td></td> </tr> </table> | | | | | NMAU | Underflow of tolerance value | <i>not matching, underflow</i> | NMAL | Tolerance value exceeded | <i>not matching, overflow</i> | INV | Measurement invalid | <i>invalid</i> | OK | all tolerances matched | |
| NMAU | Underflow of tolerance value | <i>not matching, underflow</i> | | | | | | | | | | | | | | |
| NMAL | Tolerance value exceeded | <i>not matching, overflow</i> | | | | | | | | | | | | | | |
| INV | Measurement invalid | <i>invalid</i> | | | | | | | | | | | | | | |
| OK | all tolerances matched | | | | | | | | | | | | | | | |

| CALCulate[:SCALar]:MULTitone:AF1Channel:MATChing:LIMit? | | Limit Matching, Overall | | |
|---|------------------------|-------------------------|-----------|----------|
| CALCulate[:SCALar]:MULTitone:AF2Channel:MATChing:LIMit? | | | | |
| Returned result | Value range | Def. value | Def. unit | FW vers. |
| Limit matching at tone 1, | For tones 1 to 20: | INV | - | V3.00 |
| ..., | | | | |
| Limit matching at tone 20 | NMAU NMAL INV OK | | | |
| Description of command | | | | |
| <p>This command is always a query. It indicates whether and in which way the error limits at all test tones 1 to 20 have been exceeded. The output string contains 20 values separated by commas.</p> | | | | |

| CALCulate:ARRAY:MULTitone:AF1Channel:MATChing:LIMit? | | Limit Matching, Overall | | |
|--|--|-------------------------|-----------|----------|
| CALCulate:ARRAY:MULTitone:AF2Channel:MATChing:LIMit? | | | | |
| Returned result | Value range | Def. value | Def. unit | FW vers. |
| 20 bit field, | Indicator for upper limit matching at tone 1 to 20 | NAN | - | V3.00 |
| 20 bit field | Indicator for lower limit matching at tone 1 to 20 | NAN | - | |
| Description of command | | | | |
| <p>This command is always a query. Any bit of the two returned fields that is set indicates that the limits at the corresponding point are exceeded.</p> | | | | |

MULTitone:STEReo Subsystem

The commands in the ...MULTitone:STEReo... subsystem control the *Stereo* application of the *Multitone* measurement.

Measurement Control – Subsystem MULTitone

The subsystem *MULTitone* corresponds to the measurement control softkey in the measurement menu *Multitone* and some of the associated hotkeys.

| | | |
|--|--|---------------|
| INITiate:MULTitone:STEReo | Start new measurement | ⇒ <i>RUN</i> |
| ABORt:MULTitone:STEReo | Abort running measurement and switch off | ⇒ <i>OFF</i> |
| STOP:MULTitone:STEReo | Stop measurement after current stat. cycle | ⇒ <i>STOP</i> |
| CONTinue:MULTitone:STEReo | Next measurement step (only <i>stepping mode</i>) | ⇒ <i>RUN</i> |
| Description of command | | FW vers. |
| These commands have no query form. They start and stop the measurement, setting it to the status indicated in the top right column. | | V4.50 |
| Note: <i>The single tone AF generator must be switched off before a multitone measurement is started. See note in section Audio Generator and Analyzer in the operating manual.</i> | | |

| CONFigure:MULTitone:STEReo:EREPorting <Mode> | | Event Reporting> | | |
|--|---------------------------|------------------|-----------|----------|
| <Mode> | Description of parameters | Def. value | Def. unit | FW vers. |
| SRQ | Service request | OFF | – | V4.50 |
| SOPC | Single operation complete | | | |
| SRSQ | SRQ and SOPC | | | |
| OFF | No reporting | | | |
| Description of command | | | | |
| This command defines the events generated when the measurement is terminated or stopped (<i>event reporting</i> , see chapter 5 of the operating manual). | | | | |

| FETCH:MULTitone:STEReo:STATus? | | Measurement Status | | |
|--|---|--------------------|-----------|----------|
| Ret. values | Description of parameters | Def. value | Def. unit | FW vers. |
| OFF | Measurement in the <i>OFF</i> state (*RST or ABORt) | OFF | – | V4.50 |
| RUN | Running (after INITiate, CONTinue or READ) | | | |
| STOP | Stopped (STOP) | | | |
| ERR | <i>OFF</i> (could not be started) | | | |
| STEP | Stepping mode (<stepmode>=STEP) | | | |
| RDY, | Stopped according to repetition mode and stop condition | | | |
| 1 to 10000 | Counter for current statistics cycle | | | |
| NONE | No counting mode set | NONE | – | |
| Description of command | | | | |
| This command is always a query. It returns the status of the measurement (see chapters 3 and 5 of the operating manual). | | | | |

Test Configuration

The commands of the following subsystems configure the *Multitone* measurement. They correspond to the *Multitone Configuration* menu.

Subsystem MULTitone:...CONTROL

The subsystem *MULTitone:...CONTROL* defines the scope of the measurement. It corresponds to the *Control* tab in the popup menu *Multitone Configuration*.

| CONFigure:MULTitone:STEReo:CONTROL:REPetition <Repetition>, <StopCond>, <Stepmode> | | | | Test Cycles |
|---|--|------------|-----------|-------------|
| <Repetition> | Description of parameters | Def. value | Def. unit | |
| CONTInuous SINGleshot 1 to 10000, | Continuous measurement (until STOP or ABORT) Single shot measurement (until Status = RDY) Multiple measurement (counting, until Status = STEP RDY) | SING | – | |
| <StopCond> | Description of parameters | Def. value | Def. unit | |
| SONerror NONE, | Stop measurement in case of error (stop on error) Continue measurement even in case of error | NONE | – | |
| <Stepmode> | Description of parameters | Def. value | Def. unit | FW vers. |
| STEP NONE | Interrupt measurement after each statistics cycle Continue measurement according to its rep. mode | NONE | – | V4.50 |
| Description of command | | | | |
| This command determines the number of statistics cycles, the stop condition and the stepping mode for the measurement. | | | | |
| Note: For READ commands (READ:...), the <Repetition> parameter has no effect; the measurement is always stopped after a single shot. | | | | |

| CONFigure:MULTitone:STEReo:COUPLing <Coupling_1>, <Coupling_2> | | | | Path Coupling (AF IN) |
|--|---|------------|-----------|-----------------------|
| <Coupling_1> | Description of parameters | Def. value | Def. unit | FW vers. |
| AC DC | AC or DC coupling for the AF channel 1 signal (measured at AF 1 IN) | AC | – | V4.50 |
| <Coupling_2> | Description of parameters | Def. value | Def. unit | FW vers. |
| AC DC | AC or DC coupling for the AF channel 2 signal (measured at AF 2 IN) | DC | – | V4.50 |
| Description of command | | | | |
| This command determines the AF path coupling for multitone measurements. | | | | |

| CONFigure:MULTitone:STEReo:RLEVEL <Voltage_1>, <Voltage_2> | | | | AF Reference Level |
|--|----------------------------------|------------|-----------|--------------------|
| <Voltage_1> | Description of parameters | Def. value | Def. unit | FW vers. |
| 0.001 V to 5.000 V | Reference Level for AF channel 1 | 0.010 | V | V4.50 |
| <Voltage_2> | Description of parameters | Def. value | Def. unit | FW vers. |
| 0.001 V to 5.000 V | Reference Level for AF channel 2 | 0.010 | V | V4.50 |
| Description of command | | | | |
| This command defines the AF reference level, i.e. the 0-dB line in the test diagram. | | | | |

| CONFigure:MULTitone:STEReo:RMODE <Reference_1>, <Reference_2> | | | | Result |
|--|---|------------|-----------|----------|
| <Reference_1> | Description of parameters | Def. value | Def. unit | FW vers. |
| RLEV TON<nr> | Results relative to the reference level Results relative to level at test tone <nr>, where <nr> = 1 to 20 | TON4 | – | V4.50 |
| <Reference_2> | Description of parameters | Def. value | Def. unit | FW vers. |
| RLEV TON<nr> | Results relative to the reference level Results relative to level at test tone <nr>, where <nr> = 1 to 20 | TON4 | – | V4.50 |
| Description of command | | | | |
| This command defines the reference value for the results of the <i>Multitone</i> measurement. The reference level is defined via CONFigure:MULTitone:STEReo:RLEVel. To choose one of the test tones no. 1 to 20, it must be enabled via the CONFigure:MULTitone:STEReo:TDEFinition:TONE<nr> command. | | | | |

| CONFigure:MULTitone:STEReo:AFGLead <Time_1>, <Time_2> | | | | AF Generator Lead |
|--|--------------------------------|------------|-----------|-------------------|
| <Time_1> | Description of parameters | Def. value | Def. unit | FW vers. |
| 0 s to 0.1 s, | Hold off time for AF channel 1 | 0.014 | s | V4.50 |
| <Time_2> | Description of parameters | Def. value | Def. unit | FW vers. |
| 0 s to 0.1 s | Hold off time for AF channel 2 | 0.014 | s | V4.50 |
| Description of command | | | | |
| This command defines a hold off time for the AF generator. | | | | |

Tolerance values – Subsystem MULTitone:...LIMit

The subsystem *MULTitone:...LIMit* defines tolerance values for the *Multitone* measurement. The subsystem corresponds to the *Limits* tab of the popup menu *Multitone Configuration*.

| CONFigure:MULTitone:STEReo:LIMit:LINE:ASYMmetric:UPPer | | | | Upper Limit, Overall | |
|--|---|---------------|------------------------|------------------------|---------------|
| <Limit_1_1>, <Enable_1_1>, ... <Limit_20_1>, <Enable_20_1> , <Limit_1_2>, <Enable_1_2>, ... <Limit_20_2>, <Enable_20_2> | | | | | |
| <Limit_nr_ch> | Description of parameters | Def. value | Def. unit | | |
| -80 dB to +80 dB, | Upper limit line at tone <nr> and audio channel <ch> | See below | dB | | |
| <Enable_nr_ch> | Description of parameters | Def. value | Def. unit | FW vers. | |
| ON OFF | Enable upper limit line at tone <nr> and audio channel <ch> | ON | - | V4.50 | |
| Description of command | | | | | |
| This command configures the upper limit lines and enables the limit check at the 20 test tones that can be defined via CONFigure:MULTitone:STEReo:TONE<nr>. | | | | | |
| By default, the limit check is switched on at all tones and the following limit lines apply to both audio channels: | | | | | |
| Tone <nr> | Limit Line/[dB] | Enable | Tone <nr> | Limit Line/[dB] | Enable |
| 1 | -9.5 | ON | 11 | +5.6 | ON |
| 2 | -6.2 | ON | 12 | +6.3 | ON |
| 3 | -3.8 | ON | 13 | +6.9 | ON |
| 4 | -1.9 | ON | 14 | +7.5 | ON |
| 5 | -0.3 | ON | 15 | +8.0 | ON |
| 6 | +1.0 | ON | 16 | +8.6 | ON |
| 7 | +2.1 | ON | 17 | +9.1 | ON |
| 8 | +3.1 | ON | 18 | +9.6 | ON |
| 9 | +4.0 | ON | 19 | +10.0 | ON |
| 10 | +4.8 | ON | 20 | +10.5 | ON |

| CONFigure:MULTitone:STEReo:TONE<nr>:LIMit:LINE:ASYMmetric:UPPer | | | | Upper Limit, Single Point | |
|---|---|------------|-----------|---------------------------|--|
| <Limit_1>, <Enable_1>, <Limit_2>, <Enable_2> | | | | | |
| <Limit_ch> | Description of parameters | Def. value | Def. unit | | |
| -80 dB to +80 dB, | Upper limit line at tone <nr> and audio channel <ch> | See below | dB | | |
| <Enable_ch> | Description of parameters | Def. value | Def. unit | FW vers. | |
| ON OFF | Enable upper limit line at tone <nr> and audio channel <ch> | ON | - | V4.50 | |
| Description of command | | | | | |
| This command configures the upper limit and enables the limit check at one of 20 test tones that can be defined via CONFigure:MULTitone:STEReo:TONE<nr>. The test tones are numbered by <nr> = 1 to 20. The default limits at all test points are quoted in the previous command. | | | | | |

| CONFigure:MULTitone:STEReo:LIMit:LINE:ASYMmetric:LOWer | | | Lower Limits, Overall | | |
|---|---|------------|-----------------------|-----------------|--------|
| <p><Limit_1_1>, <Enable_1_1>, ... <Limit_20_1>, <Enable_20_1> , <Limit_1_2>, <Enable_1_2>, ... <Limit_20_2>, <Enable_20_2></p> | | | | | |
| <Limit_nr_ch> | Description of parameters | Def. value | Def. unit | | |
| -80 dB to +80 dB, | Lower limit line at tone <nr> and audio channel <ch> | See below | dB | | |
| <Enable_nr_ch> | Description of parameters | Def. value | Def. unit | FW vers. | |
| ON OFF | Enable lower limit line at tone <nr> and audio channel <ch> | ON | - | V4.50 | |
| Description of command | | | | | |
| <p>This command configures the lower limit lines and enables the limit check at the 20 test tones that can be defined via CONFigure:MULTitone:STEReo:TONE<nr>.</p> <p>By default, the limit check is switched on at all tones and the following limit lines apply to both audio channels:</p> | | | | | |
| Tone <nr> | Limit Line/[dB] | Enable | Tone <nr> | Limit Line/[dB] | Enable |
| 1 | -13.5 | ON | 11 | +1.6 | ON |
| 2 | -10.2 | ON | 12 | +2.3 | ON |
| 3 | -7.8 | ON | 13 | +2.9 | ON |
| 4 | -5.9 | ON | 14 | +3.5 | ON |
| 5 | -4.3 | ON | 15 | +4.0 | ON |
| 6 | -3.0 | ON | 16 | +4.6 | ON |
| 7 | -1.9 | ON | 17 | +5.0 | ON |
| 8 | -0.9 | ON | 18 | +5.0 | ON |
| 9 | 0.0 | ON | 19 | +5.0 | ON |
| 10 | +0.8 | ON | 20 | +5.0 | ON |

| CONFigure:MULTitone:STEReo:TONE<nr>:LIMit:LINE:ASYMmetric:LOWer | | | Lower Limit, Single Point | | |
|--|---|------------|---------------------------|----------|--|
| <p><Limit_1>, <Enable_1>, <Limit_2>, <Enable_2></p> | | | | | |
| <Limit_ch> | Description of parameters | Def. value | Def. unit | | |
| -80 dB to +80 dB, | Lower limit line at tone <nr> and audio channel <ch> | See below | dB | | |
| <Enable_ch> | Description of parameters | Def. value | Def. unit | FW vers. | |
| ON OFF | Enable lower limit line at tone <nr> and audio channel <ch> | ON | - | V4.50 | |
| Description of command | | | | | |
| <p>This command configures the lower limit and enables the limit check at one of 20 test tones that can be defined via CONFigure:MULTitone:STEReo:TONE<nr>. The test tones are numbered by <nr> = 1 to 20. The default limits at all test points are quoted in the previous command.</p> | | | | | |

| DEFault:MULTitone:STEReo:LIMit:LINE <Enable> | | | Default Settings | | |
|--|---|------------|------------------|----------|--|
| <Enable> | Description of parameters | Def. value | Def. unit | FW vers. | |
| ON OFF | The parameters are set to their default values Some or all parameters differ from the default values | ON | - | V4.50 | |
| Description of command | | | | | |
| <p>If used as a setting command with the parameter ON this command sets all parameters of the subsystem to their default values (the setting OFF results in an error message).</p> <p>If used as a query the command returns whether all parameters are set to their default values (ON) or not (OFF).</p> | | | | | |

Test Tones – Subsystem MULTitone:...TDEFinition

The subsystem *MULTitone:...TDEFinition* configures the audio test signal used for the *Multitone* measurement. The subsystem corresponds to the *Tone Def.* tab of the popup menu *Multitone Configuration*.

| CONFigure:MULTitone:STEReo:TDEFinition | | Test Tones, analog generators | | | | | |
|--|---|-------------------------------|-----------|-----------|----------------|-----------|--------|
| <p><Freq_1_1>, <Lev_1_1>, <Enable_1_1>, ... <Freq_20_1>, <Lev_20_1>, <Enable_20_1> <Freq_1_2>, <Lev_1_2>, <Enable_1_2>, ... <Freq_20_2>, <Lev_20_2>, <Enable_20_2></p> | | | | | | | |
| <Freq_nr_ch> | Description of parameters | Def. value | Def. unit | | | | |
| 10 Hz to 16000 Hz, | Frequency of test tone <nr> and audio channel <ch> | See below | Hz | | | | |
| <Lev_nr_ch > | Description of parameters | Def. value | Def. unit | | | | |
| 0.0 V to 5.0 V ^{*)} , | Level at test tone <nr> and audio channel <ch> | See below | V | | | | |
| <Enable_nr_ch > | Description of parameters | Def. value | Def. unit | FW vers. | | | |
| ON OFF | Switch on / off test tone <nr> and audio channel <ch> | See below | – | V4.50 | | | |
| Description of command | | | | | | | |
| <p>This command enables and configures up to 20 test tones for test scenarios where an analog generator is used. The minimum frequency spacing between two tones is 1 Hz. The sum of all test tones must not exceed the maximum AF generator level quoted in the data sheet.</p> <p>*) The sum of the levels of all enabled tones must not exceed 5.0 V.</p> <p>The following default test tones are provided for both audio channels:</p> | | | | | | | |
| Tone <nr> | Frequency/[Hz] | Level/[V] | Enable | Tone <nr> | Frequency/[Hz] | Level/[V] | Enable |
| 1 | 300 | 0.01 | ON | 11 | 1700 | 0.01 | ON |
| 2 | 440 | 0.01 | ON | 12 | 1840 | 0.01 | ON |
| 3 | 580 | 0.01 | ON | 13 | 1980 | 0.01 | ON |
| 4 | 720 | 0.01 | ON | 14 | 2120 | 0.01 | ON |
| 5 | 860 | 0.01 | ON | 15 | 2260 | 0.01 | ON |
| 6 | 1004 | 0.01 | ON | 16 | 2400 | 0.01 | ON |
| 7 | 1140 | 0.01 | ON | 17 | 2540 | 0.01 | ON |
| 8 | 1280 | 0.01 | ON | 18 | 2680 | 0.01 | ON |
| 9 | 1420 | 0.01 | ON | 19 | 2820 | 0.01 | ON |
| 10 | 1560 | 0.01 | ON | 20 | 3000 | 0.01 | ON |
| <p>Note: If the level of all test tones is derived from a total level (TLEVel setting in the CONFigure:MULTitone:AF1Channel:TDEFinition:MODE command), the individual level settings are ignored. The <Frequency> and <Enable> parameter settings are still effective.</p> | | | | | | | |

| CONFigure:MULTitone:STEReo:TDEFinition:TONE<nr> | | | | Test Tones, analog generators |
|---|---|------------|-----------|-------------------------------|
| <Frequency_1>, <Level_1>, <Enable_1>, <Frequency_2>, <Level_2>, <Enable_2> | | | | |
| <Frequency_ch> | Description of parameters | Def. value | Def. unit | |
| 10 Hz to 16000 Hz, | Frequency of test tone <nr> and audio channel <ch> | See below | Hz | |
| <Level_ch> | Description of parameters | Def. value | Def. unit | |
| 0.0 V to 5.0 V ^{*)} , | AF level test tone <nr> and audio channel <ch> | See below | V | |
| <Enable_ch> | Description of parameters | Def. value | Def. unit | FW vers. |
| ON OFF | Switch on / off test tone <nr> and audio channel <ch> | See below | – | V4.50 |
| Description of command | | | | |
| This command enables and configures one of up to 20 test tones (<nr> = 1 to 20) for test scenarios where an analog generator is used. The default values for all test tones are given in the previous commands. | | | | |
| *) The sum of the levels of all enabled tones must not exceed 5.0 V. | | | | |
| Note: If the level of all test tones is derived from a total level (TLEVEL setting in the CONFigure:MULTitone:AF1Channel:TDEFinition:MODE command), the <Level> setting is ignored. The <Frequency> and <Enable> parameter setting is still effective. | | | | |

| CONFigure:MULTitone:STEReo:TDEFinition:MODE <Mode_1>, <Mode_2> | | | | Level Selection |
|---|---|------------|-----------|-----------------|
| <Mode_ch> | Description of parameters | Def. value | Def. unit | FW vers. |
| SEParate | Use separate levels for each tone in audio channel <ch> | SEParate | – | V4.50 |
| TLEVel | Use total level | | | |
| Description of command | | | | |
| This command defines how the voltage of each of the test tones is determined. | | | | |
| <ul style="list-style-type: none"> In the default setting SEParate, the levels of all tones are defined separately and may differ from each other (see command CONFigure:MULTitone:...:TDEFinition above). In the setting TLEV, the total AF generator level set via CONFigure:MULTitone: ...:TDEFinition:TLEVel is evenly distributed among all enabled test tones. Test tones can still be enabled or disabled and their frequency can be changed (see CONF:MULT:...:TDEF... commands above), but level settings will be ignored as long as TLEV remains effective. | | | | |

| CONFigure:MULTitone:STEReo:TDEFinition:TLEVel <Total_Level_1>, <Total_Level_2> | | | | Total Level, analog generators |
|---|---|------------|-----------|--------------------------------|
| <Total_Level_ch> | Description of parameters | Def. value | Def. unit | FW vers. |
| 0.010 mV to 5.0 V | Total level/voltage (sum of all test tones) in audio channel <ch> | 0.200 | V | V4.50 |
| Description of command | | | | |
| This command defines the total AF generator level for test scenarios where an analog generator is used. The total level is evenly distributed among all enabled test tones. This level setting comes into effect after the level selection mode is set to TLEV (see CONFigure:MULTitone:...:TDEFinition:MODE command above). The total level must not exceed the maximum AF generator level quoted in the data sheet. | | | | |

| Default: MULTitone: STEReo: TDEFinition <Enable> | | Default Settings | | |
|--|---|------------------|-----------|----------|
| <Enable> | Description of parameters | Def. value | Def. unit | FW vers. |
| ON | The parameters are set to their default values | ON | – | V4.50 |
| OFF | Some or all parameters differ from the default values | | | |
| Description of command | | | | |
| If used as a setting command with the parameter <i>ON</i> this command sets all parameters of the subsystem to their default values (the setting <i>OFF</i> results in an error message). If used as a query the command returns whether all parameters are set to their default values (<i>ON</i>) or not (<i>OFF</i>). | | | | |

Path Configuration – Subsystem MULTitone: STEReo: FILTER

The subsystem *MULTitone: STEReo: FILTER* configures the voice-processing equipment used for the *Multitone* measurement. The subsystem corresponds to the *Filters* tab of the popup menu *Multitone Configuration*.

| CONFigure: MULTitone: STEReo: FILTER: BPASSs: DCCoupling <Bandpass_1>, <Bandpass_2> | | Band Pass, DC Coupling | | |
|---|---|------------------------|-----------|----------|
| <Bandpass_ch> | Description of parameters | Def. value | Def. unit | FW vers. |
| | R&S CMU band pass filter for audio channel <ch> with a bandwidth of | BP17 | – | V4.50 |
| BP02 | 6 Hz to 250 Hz | | | |
| BP03 | 50 Hz to 250 Hz | | | |
| BP05 | 6 Hz to 3000 Hz | | | |
| BP06 | 50 Hz to 3000 Hz | | | |
| BP07 | 300 Hz to 3000 Hz | | | |
| BP09 | 6 Hz to 4000 Hz | | | |
| BP10 | 50 Hz to 4000 Hz | | | |
| BP11 | 300 Hz to 4000 Hz | | | |
| BP13 | 6 Hz to 15000 Hz | | | |
| BP14 | 50 Hz to 15000 Hz | | | |
| BP15 | 300 Hz to 15000 Hz | | | |
| BP17 | 6 Hz to 21000 Hz | | | |
| BP18 | 50 Hz to 21000 Hz | | | |
| BP19 | 500 Hz to 5000 Hz | | | |
| Description of command | | | | |
| This command selects the band pass filter to be used if the AF path coupling is set to DC (see CONFigure: AFAnalyzer[:PRIMary]:COUpling command). | | | | |

| CONFigure:MULTitone:STEReo:FILTer:BPASs:ACCoupling <<Bandpass_1>, <Bandpass_2> | | Band Pass, AC Coupling | | |
|--|---|------------------------|-----------|----------|
| <Bandpass_ch> | Description of parameters | Def. value | Def. unit | FW vers. |
| | R&S CMU band pass filter for audio channel <ch> with a bandwidth of | BP16 | – | V4.50 |
| BP01 | 0 Hz to 250 Hz | | | |
| BP02 | 6 Hz to 250 Hz | | | |
| BP03 | 50 Hz to 250 Hz | | | |
| BP04 | 0 Hz to 3000 Hz | | | |
| BP05 | 6 Hz to 3000 Hz | | | |
| BP06 | 50 Hz to 3000 Hz | | | |
| BP07 | 300 Hz to 3000 Hz | | | |
| BP08 | 0 Hz to 4000 Hz | | | |
| BP09 | 6 Hz to 4000 Hz | | | |
| BP10 | 50 Hz to 4000 Hz | | | |
| BP11 | 300 Hz to 4000 Hz | | | |
| BP12 | 0 Hz to 15000 Hz | | | |
| BP13 | 6 Hz to 15000 Hz | | | |
| BP14 | 50 Hz to 15000 Hz | | | |
| BP15 | 300 Hz to 15000 Hz | | | |
| BP16 | 0 Hz to 21000 Hz | | | |
| BP17 | 6 Hz to 21000 Hz | | | |
| BP 18 | 50 Hz to 21000 Hz | | | |
| BP19 | 500 Hz to 5000 Hz | | | |
| Description of command | | | | |
| This command selects the band pass filter to be used if the AF path coupling is set to AC (see CONFigure:AFAnalyzer[:PRIMary]:COUpling command). | | | | |

| CONFigure:MULTitone:STEReo:FILTer:WEIGHting <Weighting_1>, <Weighting_2> | | Weighting | | |
|---|--|------------|-----------|----------|
| <Weighting_ch> | Description of parameters | Def. value | Def. unit | FW vers. |
| A | Switch on A-weighted filter for audio channel <ch> | OFF | – | V4.50 |
| CME | Switch on C-message weighted filter | | | |
| CCI | Switch on CCITT weighting filter | | | |
| OFF | No weighting filter | | | |
| Description of command | | | | |
| This command selects the weighting filter to be included in the AF input signal path. | | | | |

| DEFault:MULTitone:STEReo:FILTer <Enable> | | Default Settings | | |
|---|---|------------------|-----------|----------|
| <Enable> | Description of parameters | Def. value | Def. unit | FW vers. |
| ON | The parameters are set to their default values | ON | – | V4.50 |
| OFF | Some or all parameters differ from the default values | | | |
| Description of command | | | | |
| If used as a setting command with the parameter ON this command sets all parameters of the subsystem to their default values (the setting OFF results in an error message). | | | | |
| If used as a query the command returns whether all parameters are set to their default values (ON) or not (OFF). | | | | |

Results – Subsystem MULTitone:…?

The subsystem *MULTitone:…?* measures the AF input level, returns the results and compares them with the tolerance values. The subsystem corresponds to the various output elements in the measurement menu *Multitone*.

| READ[:SCALar]:MULTitone:STEReo:AF1Channel:TONE<nr>? | | Multitone Results, single channels | | |
|--|---------------------------|--|-----------|----------|
| READ[:SCALar]:MULTitone:STEReo:AF2Channel:TONE<nr>? | | Multitone Results, single channels | | |
| | | Start single shot measurement and return results | | ⇒ RUN |
| FETCh[:SCALar]:MULTitone:STEReo:AF1Channel:TONE<nr>? | | Multitone Results, single channels | | |
| FETCh[:SCALar]:MULTitone:STEReo:AF2Channel:TONE<nr>? | | Multitone Results, single channels | | |
| | | Read results (unsynchronized) | | ⇒ RUN |
| Returned values | Description of parameters | Def. value | Def. unit | FW vers. |
| -100.0 dB to +20.0 dB | AF response at point <nr> | NAN | dB | V4.50 |
| Description of command | | | | |
| These commands are always queries. They return the audio level at test tones <nr> (<nr> = 1 to 20) defined via <code>CONFigure:MULTitone:STEReo:AF1Channel:TONE<nr></code> . | | | | |

| READ[:SCALar]:MULTitone:STEReo:TONE<nr>? | | Multitone Results, both channels | | |
|---|--|--|-----------|----------|
| | | Start single shot measurement and return results | | ⇒ RUN |
| FETCh[:SCALar]:MULTitone:STEReo:TONE<nr>? | | Multitone Results, both channels | | |
| | | Read results (unsynchronized) | | ⇒ RUN |
| Returned values | Description of parameters | Def. value | Def. unit | FW vers. |
| -100.0 dB to +20.0 dB | AF response at point <nr> and audio channel 1, | NAN | dB | V4.50 |
| -100.0 dB to +20.0 dB | AF response at point <nr> and audio channel 2 | NAN | dB | |
| Description of command | | | | |
| These commands are always queries. They return the audio level at test tones <nr> (<nr> = 1 to 20) defined via <code>CONFigure:MULTitone:STEReo:TONE<nr></code> . | | | | |

| READ:ARRay:MULTitone:STEReo:AF1Channel? | | Multitone Results, single channels | | |
|---|--|--|-----------|----------|
| | | Start single shot measurement and return results | | ⇒ RUN |
| READ:ARRay:MULTitone:STEReo:AF2Channel? | | Multitone Results, single channels | | |
| | | Read meas. results (unsynchronized) | | ⇒ RUN |
| FETCh:ARRay:MULTitone:STEReo:AF1Channel? | | Multitone Results, single channels | | |
| FETCh:ARRay:MULTitone:STEReo:AF2Channel? | | Multitone Results, single channels | | |
| Returned values | Description of parameters | Def. value | Def. unit | FW vers. |
| -100.0 dB to +20.0 dB, | FreqResp[1], 1 st value for AF response | NAN | dB | V4.50 |
| ... | ... | ... | ... | |
| -100.0 dB to +20.0 dB | FreqResp[20], 20th value for AF resp. | NAN | dB | |
| Description of command | | | | |
| These commands are always queries. They return the audio level at the 20 test tones defined via <code>CONFigure:MULTitone:STEReo:AF1Channel:TONE<nr></code> . | | | | |

| | | Multitone Results, both channels | | |
|---|---|--|-----------|----------|
| READ:ARRay:MULTitone:STEReo? | | Start single shot measurement and return results | ⇒ RUN | |
| FETCh:ARRay:MULTitone:STEReo? | | Read meas. results (unsynchronized) | ⇒ RUN | |
| Returned values | Description of parameters | Def. value | Def. unit | FW vers. |
| -100.0 dB to +20.0 dB, | FreqResp[1], 1 st value for AF response in ch. 1 | NAN | dB | V4.50 |
| ... | ... | ... | ... | |
| -100.0 dB to +20.0 dB, | FreqResp[20], 20th value for AF resp. in ch. 1 | NAN | dB | |
| -100.0 dB to +20.0 dB, | FreqResp[1], 1 st value for AF response in ch. 2 | NAN | dB | |
| ... | ... | ... | ... | |
| -100.0 dB to +20.0 dB | FreqResp[20], 20th value for AF resp. in ch. 2 | NAN | dB | |
| Description of command | | | | |
| These commands are always queries. They return the audio level at the 20 test tones defined via CONFIG-ure:MULTitone:STEReo:TONE<nr>. | | | | |

| | | Limit Matching, single channels | | |
|--|------------------------------|---------------------------------|-----------|----------|
| CALCulate[:SCALar]:MULTitone:STEReo:AF1Channel:TONE<nr>:MATChing:LIMit? | | | | |
| CALCulate[:SCALar]:MULTitone:STEReo:AF2Channel:TONE<nr>:MATChing:LIMit? | | | | |
| Returned result | Value range | Def. value | Def. unit | FW vers. |
| Limit matching at tone <nr> | NMAU NMAL INV OK | INV | - | V4.50 |
| Description of command | | | | |
| This command is always a query. It indicates whether and in which way the error limits at tone <nr> (<nr> = 1 to 20) have been exceeded. | | | | |
| The following messages may be returned for test tone <nr>: | | | | |
| NMAU | Underflow of tolerance value | <i>not matching, underflow</i> | | |
| NMAL | Tolerance value exceeded | <i>not matching, overflow</i> | | |
| INV | Measurement invalid | <i>invalid</i> | | |
| OK | all tolerances matched | | | |

| | | Limit Matching, both channels | | |
|---|------------------------|-------------------------------|-----------|----------|
| CALCulate[:SCALar]:MULTitone:STEReo:TONE<nr>:MATChing:LIMit? | | | | |
| Returned result | Value range | Def. value | Def. unit | FW vers. |
| Limit matching at tone <nr> and ch. 1, | NMAU NMAL INV OK | INV | - | V4.50 |
| Limit matching at tone <nr> and ch. 2 | NMAU NMAL INV OK | INV | - | |
| Description of command | | | | |
| This command is always a query. It indicates whether and in which way the error limits at tone <nr> (<nr> = 1 to 20) have been exceeded; see command above. | | | | |

| | | Limit Matching, Overall, single channels | | |
|--|------------------------|--|-----------|----------|
| CALCulate[:SCALar]:MULTitone:STEReo:AF1Channel:MATChing:LIMit? | | | | |
| CALCulate[:SCALar]:MULTitone:STEReo:AF2Channel:MATChing:LIMit? | | | | |
| Returned result | Value range | Def. value | Def. unit | FW vers. |
| Limit matching at tone 1, | For tones 1 to 20: | INV | - | V4.50 |
| ..., | | | | |
| Limit matching at tone 20 | NMAU NMAL INV OK | | | |
| Description of command | | | | |
| This command is always a query. It indicates whether and in which way the error limits at all test tones 1 to 20 have been exceeded. The output string contains 20 values separated by commas. | | | | |

| CALCulate[:SCALar]:MULTitone:STEReo:MATChing:LIMit? | | Limit Matching, Overall, both channels | | |
|--|--|--|-----------|----------|
| Returned result | Value range | Def. value | Def. unit | FW vers. |
| Limit matching at tone 1 and ch. 1, ..., Limit matching at tone 20 and ch. 1, Limit matching at tone 1 and ch. 2, ..., Limit matching at tone 20 and ch. 2 | For tones 1 to 20 and both channels: NMAU NMAL INV OK | INV | – | V4.50 |
| Description of command | | | | |
| This command is always a query. It indicates whether and in which way the error limits at all test tones 1 to 20 have been exceeded. The output string contains 40 values separated by commas. | | | | |

| CALCulate:ARRAy:MULTitone:STEReo:AF1Channel:MATChing:LIMit? CALCulate:ARRAy:MULTitone:STEReo:AF2Channel:MATChing:LIMit? | | Limit Matching, Overall, single channels | | |
|---|--|--|-----------|----------|
| Returned result | Value range | Def. value | Def. unit | FW vers. |
| 20 bit field, 20 bit field | Indicator for upper limit matching at tone 1 to 20 Indicator for lower limit matching at tone 1 to 20 | NAN NAN | – – | V4.50 |
| Description of command | | | | |
| This command is always a query. Any bit of the two returned fields that is set indicates that the limits at the corresponding point are exceeded. | | | | |

| CALCulate:ARRAy:MULTitone:STEReo:MATChing:LIMit? | | Limit Matching, Overall, both channels | | |
|---|--|--|------------------|----------|
| Returned result | Value range | Def. value | Def. unit | FW vers. |
| 20 bit field, 20 bit field, 20 bit field, 20 bit field | Indicator for upper limit matching at tone 1 to 20, ch. 1 Indicator for lower limit matching at tone 1 to 20, ch. 1 Indicator for upper limit matching at tone 1 to 20, ch. 2 Indicator for lower limit matching at tone 1 to 20, ch. 2 | NAN NAN NAN NAN | – – – – | V4.50 |
| Description of command | | | | |
| This command is always a query. Any bit of the two returned fields that is set indicates that the limits at the corresponding point are exceeded. | | | | |

Total Harmonic Noise Measurement (THD)

The subsystem *THD* provides a single-frequency audio test signal with selectable power and measures the power at the generator frequency (1st harmonic labeled d1) and at the 2nd, 3rd ... 9th harmonics. The subsystem corresponds to the measurement menu *THD* and the associated popup menu *THD Configuration*.

The *THD* measurement provides two independent circuits:

- In the first audio channel (subsystem *THD:AF1Channel...*), the audio signals are applied to the connectors AF OUT (output, AF generator signal) and AF IN (input) on the R&S CMU front panel. The first audio channel corresponds to the *THD* menu, application *AF Chan. One*, and the associated sections in the configuration menu.
- In the second audio channel (subsystem *THD:AF2Channel...*), the audio signals are applied to the connectors AUX 2 (output, AF generator signal) and AUX 1 (input) on the R&S CMU front panel. The second audio channel corresponds to the *THD* menu, application *AF Chan. Two*, and the associated sections in the configuration menu.

With the exception of the input and output connectors, the two audio circuits are identical. All remote control commands are analogous.

The *Stereo* application is a combination of the previous two applications, where the R&S generates and analyzes two audio signals at equal or different frequencies. The stereo commands are reported in section [THD:STEReo Subsystem](#) on p. 6.146.

Single-Tone THD (THD:AF<n>Channel)

The commands in the following sections control the THD measurement in the first and second audio channel.

Measurement Control

The following commands correspond to the softkeys *AF Chan. One / AF Chan. Two* in the measurement menu *THD* and some of the associated hotkeys.

| | | |
|---|--|---------------|
| INITiate:THD:AF1Channel | Start new measurement | ⇒ <i>RUN</i> |
| INITiate:THD:AF2Channel | | |
| ABORt:THD:AF1Channel | Abort running measurement and switch off | ⇒ <i>OFF</i> |
| ABORt:THD:AF2Channel | | |
| STOP:THD:AF1Channel | Stop measurement after current stat. cycle | ⇒ <i>STOP</i> |
| STOP:THD:AF2Channel | | |
| CONTinue:THD:AF1Channel | Next measurement step (only <i>stepping mode</i>) | ⇒ <i>RUN</i> |
| CONTinue:THD:AF2Channel | | |
| Description of command | | FW vers. |
| These commands have no query form. They start and stop the measurement, setting it to the status indicated in the top right column. | | V4.30 |

| CONFigure:THD:AF1Channel:EREPorting <Mode> | | Event Reporting | | |
|--|---------------------------|-----------------|-----------|----------|
| CONFigure:THD:AF2Channel:EREPorting <Mode> | | | | |
| <Mode> | Description of parameters | Def. value | Def. unit | FW vers. |
| SRQ | Service request | OFF | – | V4.30 |
| SOPC | Single operation complete | | | |
| SRSQ | SRQ and SOPC | | | |
| OFF | No reporting | | | |
| Description of command | | | | |
| This command defines the events generated when the measurement is terminated or stopped (<i>event reporting</i> , see chapter 5 of the operating manual). | | | | |

| FETCh:THD:AF1Channel:STATus? FETCh:THD:AF2Channel:STATus? | | Measurement Status | | |
|--|--|--------------------|-----------|----------|
| Ret. values | Description of parameters | Def. value | Def. unit | FW vers. |
| OFF | Measurement in the OFF state (*RST or ABORT) | OFF | – | V4.30 |
| RUN | Running (after INITiate, CONTinue or READ) | | | |
| STOP | Stopped (STOP) | | | |
| ERR | OFF (could not be started) | | | |
| STEP | Stepping mode (<stepmode>=STEP) | | | |
| RDY, | Stopped according to repetition mode | | | |
| 1 to 10000 | Counter for current statistics cycle | | | |
| NONE | No counting mode set | NONE | – | |
| Description of command | | | | |
| This command is always a query. It returns the status of the measurement (see chapters 3 and 5). | | | | |

Test Configuration

The commands of the following subsystems configure the THD measurement. They correspond to the THD Configuration menu.

Measurement Scope

The following commands define the scope of the measurement. They correspond to the Control tab in the popup menu THD Configuration.

| CONFigure:THD:AF1Channel:CONTRol:REPetition CONFigure:THD:AF2Channel:CONTRol:REPetition <Repetition>, <StopCond>, <Stepmode> | | Test Cycles | | |
|---|---|-------------|-----------|----------|
| <Repetition> | Description of parameters | Def. value | Def. unit | |
| CONTinuous | Continuous measurement (until STOP or ABORT) | SING | – | |
| SINGleshot | Single shot measurement (until Status = RDY) | | | |
| 1 to 10000, | Multiple measurement (counting, until Status = STEP RDY) | | | |
| <StopCond> | Description of parameters | Def. value | Def. unit | |
| NONE, | No stop condition set (no limit check) | NONE | – | |
| <Stepmode> | Description of parameters | Def. value | Def. unit | FW vers. |
| STEP | Interrupt measurement after each statistics cycle | NONE | – | V4.30 |
| NONE | Continue measurement according to its rep. mode | | | |
| Description of command | | | | |
| This command determines the number of statistics cycles, the stop condition and the stepping mode for the measurement. | | | | |
| Note: For READ commands (READ:...), the <Repetition> parameter has no effect; the measurement is always stopped after a single shot. | | | | |

| CONFigure:THD:AF1Channel:COUPLing <Coupling> | | | Path Coupling (AF IN) | |
|---|--|--------------------------------------|-----------------------|----------|
| CONFigure:THD:AF2Channel:COUPLing <Coupling> | | | | |
| <Coupling> | Description of parameters | Def. value | Def. unit | FW vers. |
| AC DC | AC coupling of AF path DC coupling of AF path | AC (:AF1Channel) DC (:AF2Channel) | – | V4.50 |
| Description of command | | | | |
| This command determines the AF path coupling for the THD measurement. | | | | |

| CONFigure:THD:AF1Channel:HARMONics<nr> <Enable> | | | Test Tones | |
|---|--|------------|------------|----------|
| CONFigure:THD:AF2Channel:HARMONics<nr> <Enable> | | | | |
| <Enable> | Description of parameters | Def. value | Def. unit | FW vers. |
| ON OFF | Enable/disable harmonic <nr> = 2 ... 9 | ON | – | V4.30 |
| Description of command | | | | |
| This command enables the harmonics no. 2 to 9 for the THD calculation. The audio levels are measured for all harmonics below 21 kHz. The first harmonic frequency is always enabled: A query returns 1 (ON), a setting command causes an SCPI error message <i>Invalid Suffix</i> . | | | | |
| The commands overwrite the CONFigure:THD:STEReo:HARMONics<nr> settings. | | | | |

| CONFigure:THD:AF1Channel:TDEFinition | | | Frequency d1, Analog Generator Level | |
|---|---|------------|--------------------------------------|----------|
| CONFigure:THD:AF2Channel:TDEFinition | | | | |
| <Frequency>, <Level> | | | | |
| <Frequency> | Description of parameters | Def. value | Def. unit | FW Vers. |
| 500 Hz to 3000 Hz, | Frequency of AF generator, d1 frequency | 1000 | Hz | V4.30 |
| <Level> | Description of parameters | Def. value | Def. unit | |
| 0.05 mV to 5.0 V | AF level | 0.01 | V | 0 |
| Description of command | | | | |
| This command configures the generator signal for the THD measurement for test scenarios where an analog generator is used. The first harmonic d1 is measured at the generator signal frequency. | | | | |
| The commands overwrite the CONFigure:THD:STEReo:TDEFinition settings. | | | | |

Path Configuration – Subsystem THD:....:FILTer

The subsystem *THD:....:FILTer* configures the voice-processing equipment used for the *THD* measurement. The subsystem corresponds to the *Filters* tab of the popup menu *THD Configuration*.

| CONFigure:THD:AF1Channel:FILTer:BPASs:DCCoupling CONFigure:THD:AF2Channel:FILTer:BPASs:DCCoupling <Bandpass> | | Band Pass, DC Coupling | | |
|--|--|------------------------|-----------|----------|
| <Bandpass> | Description of parameters | Def. value | Def. unit | FW vers. |
| | R&S CMU band pass filter with a bandwidth of | BP17 | – | V4.50 |
| BP02 | 6 Hz to 250 Hz | | | |
| BP03 | 50 Hz to 250 Hz | | | |
| BP05 | 6 Hz to 3000 Hz | | | |
| BP06 | 50 Hz to 3000 Hz | | | |
| BP07 | 300 Hz to 3000 Hz | | | |
| BP09 | 6 Hz to 4000 Hz | | | |
| BP10 | 50 Hz to 4000 Hz | | | |
| BP11 | 300 Hz to 4000 Hz | | | |
| BP13 | 6 Hz to 15000 Hz | | | |
| BP14 | 50 Hz to 15000 Hz | | | |
| BP15 | 300 Hz to 15000 Hz | | | |
| BP17 | 6 Hz to 21000 Hz | | | |
| BP18 | 50 Hz to 21000 Hz | | | |
| BP19 | 500 Hz to 5000 Hz | | | V4.50 |
| Description of command | | | | |
| This command selects the band pass filter to be used if the AF path coupling is set to DC (see CONFigure:THD:AF<nr>Channel:COUPling commands). | | | | |

| CONFigure:THD:AF1Channel:FILTer:BPASs:ACCoupling CONFigure:THD:AF2Channel:FILTer:BPASs:ACCoupling <Bandpass> | | Band Pass, AC Coupling | | |
|--|--|------------------------|-----------|----------|
| <Bandpass> | Description of parameters | Def. value | Def. unit | FW vers. |
| | R&S CMU band pass filter with a bandwidth of | BP16 | – | V4.50 |
| BP01 | 0 Hz to 250 Hz | | | |
| BP02 | 6 Hz to 250 Hz | | | |
| BP03 | 50 Hz to 250 Hz | | | |
| BP04 | 0 Hz to 3000 Hz | | | |
| BP05 | 6 Hz to 3000 Hz | | | |
| BP06 | 50 Hz to 3000 Hz | | | |
| BP07 | 300 Hz to 3000 Hz | | | |
| BP08 | 0 Hz to 4000 Hz | | | |
| BP09 | 6 Hz to 4000 Hz | | | |
| BP10 | 50 Hz to 4000 Hz | | | |
| BP11 | 300 Hz to 4000 Hz | | | |
| BP12 | 0 Hz to 15000 Hz | | | |
| BP13 | 6 Hz to 15000 Hz | | | |
| BP14 | 50 Hz to 15000 Hz | | | |
| BP15 | 300 Hz to 15000 Hz | | | |
| BP16 | 0 Hz to 21000 Hz | | | |
| BP17 | 6 Hz to 21000 Hz | | | |
| BP 18 | 50 Hz to 21000 Hz | | | |
| BP19 | 500 Hz to 5000 Hz | | | V4.50 |
| Description of command | | | | |
| This command selects the band pass filter to be used if the AF path coupling is set to AC (see CONFigure:THD:AF<nr>Channel:COUPling commands). | | | | |

| CONFigure:THD:AF1Channel:FILTer:WEIGHting <Weighting> | | | | Weighting |
|---|-------------------------------------|------------|-----------|-----------|
| CONFigure:THD:AF2Channel:FILTer:WEIGHting <Weighting> | | | | |
| <Weighting> | Description of parameters | Def. value | Def. unit | FW vers. |
| A | Switch on A-weighted filter | OFF | – | V4.50 |
| CME | Switch on C-message weighted filter | | | |
| CCI | Switch on CCITT weighting filter | | | |
| OFF | No weighting filter | | | |
| Description of command | | | | |
| This command selects the weighting filter to be included in the AF input signal path. | | | | |

| DEFault:THD:AF1Channel:FILTer <Enable> | | | | Default Settings |
|---|---|------------|-----------|------------------|
| DEFault:THD:AF2Channel:FILTer <Enable> | | | | |
| <Enable> | Description of parameters | Def. value | Def. unit | FW vers. |
| ON | The parameters are set to their default values | ON | – | V4.50 |
| OFF | Some or all parameters differ from the default values | | | |
| Description of command | | | | |
| If used as a setting command with the parameter <i>ON</i> this command sets all parameters of the subsystem to their default values (the setting <i>OFF</i> results in an error message). | | | | |
| If used as a query the command returns whether all parameters are set to their default values (<i>ON</i>) or not (<i>OFF</i>). | | | | |

| DEFault:THD:FILTer <Enable> | | | | Default Settings |
|--|---|------------|-----------|------------------|
| <Enable> | Description of parameters | Def. value | Def. unit | FW vers. |
| ON | The parameters are set to their default values | ON | – | V4.50 |
| OFF | Some or all parameters differ from the default values | | | |
| Description of command | | | | |
| If used as a setting command with the parameter <i>ON</i> this command sets all parameters of the subsystem (including <i>AF1Channel</i> and <i>AF2Channel</i>) to their default values (the setting <i>OFF</i> results in an error message). | | | | |
| If used as a query the command returns whether all parameters are set to their default values (<i>ON</i>) or not (<i>OFF</i>). | | | | |

Results – Subsystem THD:...?

The following commands start the THD measurement (*READ...*) and return the results. They correspond to the various output elements in the measurement menu *THD*.

| READ[:SCALar]:THD:AF1Channel:HARMonic<nr>? | | | | Harmonic levels, single |
|---|---------------------------|------------|-----------|--|
| READ[:SCALar]:THD:AF2Channel:HARMonic<nr>? | | | | |
| Start single shot measurement and return results | | | | ⇒ <i>RUN</i> |
| FETCh[:SCALar]:THD:AF1Channel:HARMonic<nr>? | | | | |
| FETCh[:SCALar]:THD:AF2Channel:HARMonic<nr>? | | | | Read results (unsynchronized) ⇒ <i>RUN</i> |
| Returned values | Description of parameters | Def. value | Def. unit | FW vers. |
| –140.0 dB to +140.0 dB | AF level at harmonic <nr> | NAN | dB | V4.30 |
| Description of command | | | | |
| These commands are always queries. They return the audio levels at the first harmonic frequency d1 (<nr> = 1) and at the harmonic frequencies <nr> = 2 to 9. All results are normalized to level of the first harmonic, so the first result is always 0 dB. | | | | |

| | | | | Harmonics levels, all |
|--|--|------------|-----------|-----------------------|
| READ:ARRay:THD:AF1Channel? | | | | |
| READ:ARRay:THD:AF2Channel? | Start single shot measurement and return results | | | ⇒ <i>RUN</i> |
| FETCh:ARRay:THD:AF1Channel? | | | | |
| FETCh:ARRay:THD:AF2Channel? | Read meas. results (unsynchronized) | | | ⇒ <i>RUN</i> |
| Returned values | Description of parameters | Def. value | Def. unit | FW vers. |
| -140.0 dB to +140.0 dB, | AF Level[1], 2 nd harmonic level | NAN | dB | V4.30 |
| ... | ... | ... | ... | |
| -140.0 dB to +140.0 dB | AF Level[[9], 9 th harmonic level | NAN | dB | |
| Description of command | | | | |
| These commands are always queries. They return the audio level for all harmonics d2 to d9. | | | | |

| | | | | THD results |
|---|--|------------|-----------|--------------|
| READ[:SCALar]:THD:AF1Channel:THD? | | | | |
| READ[:SCALar]:THD:AF2Channel:THD? | Start single shot measurement and return results | | | ⇒ <i>RUN</i> |
| FETCh[:SCALar]:THD:AF1Channel:THD? | | | | |
| FETCh[:SCALar]:THD:AF2Channel:THD? | Read results (unsynchronized) | | | ⇒ <i>RUN</i> |
| Returned values | Description of parameters | Def. value | Def. unit | FW vers. |
| 0 % to 100 %, | THD in percent | NAN | % | V4.30 |
| -140.0 dB to +0.0 dB | THD in dB | NAN | dB | |
| Description of command | | | | |
| These commands are always queries. They return the Total Harmonic Distortion (THD) as a percentage and as an equivalent dB-value. | | | | |

THD:STEReo Subsystem

The commands in the THD:STEReo subsystem control the *Stereo* application of the THD measurement.

Measurement Control

The following commands correspond to the softkey *AF Stereo* in the measurement menu *THD* and some of the associated hotkeys.

| | | |
|---|--|---------------|
| INITiate:THD:STEReo | Start new measurement | ⇒ <i>RUN</i> |
| ABORt:THD:STEReo | Abort running measurement and switch off | ⇒ <i>OFF</i> |
| STOP:THD:STEReo | Stop measurement after current stat. cycle | ⇒ <i>STOP</i> |
| CONTinue:THD:STEReo | Next measurement step (only <i>stepping mode</i>) | ⇒ <i>RUN</i> |
| Description of command | | FW vers. |
| These commands have no query form. They start and stop the measurement, setting it to the status indicated in the top right column. | | V4.50 |

| CONFigure:THD:STEReo:ERePorting <Mode> | | | | Event Reporting | |
|--|---------------------------|------------|-----------|-----------------|--|
| <Mode> | Description of parameters | Def. value | Def. unit | FW vers. | |
| SRQ | Service request | OFF | – | V4.50 | |
| SOPC | Single operation complete | | | | |
| SRSQ | SRQ and SOPC | | | | |
| OFF | No reporting | | | | |
| Description of command | | | | | |
| This command defines the events generated when the measurement is terminated or stopped (<i>event reporting</i> , see chapter 5 of the operating manual). | | | | | |

| FETCh:THD:STEReo:STATus? | | | | Measurement Status | |
|--|--|------------|-----------|--------------------|--|
| Ret. values | Description of parameters | Def. value | Def. unit | FW vers. | |
| OFF | Measurement in the OFF state (*RST or ABORT) | OFF | – | V4.50 | |
| RUN | Running (after INITiate, CONTinue or READ) | | | | |
| STOP | Stopped (STOP) | | | | |
| ERR | OFF (could not be started) | | | | |
| STEP | Stepping mode (<stepmode>=STEP) | | | | |
| RDY, | Stopped according to repetition mode | | | | |
| 1 to 10000 | Counter for current statistics cycle | | | | |
| NONE | No counting mode set | NONE | – | | |
| Description of command | | | | | |
| This command is always a query. It returns the status of the measurement (see chapters 3 and 5). | | | | | |

Test Configuration

The following commands define the scope of the measurement. They correspond to the *Control* tab in the popup menu *THD Configuration*.

| CONFigure:THD:STEReo:CONTRol:REPetition | | | | Test Cycles | |
|---|---|------------|-----------|-------------|--|
| <Repetition>, <StopCond>, <Stepmode> | | | | | |
| <Repetition> | Description of parameters | Def. value | Def. unit | FW vers. | |
| CONTinuous | Continuous measurement (until STOP or ABORT) | SING | – | | |
| SINGleshot | Single shot measurement (until Status = RDY) | | | | |
| 1 to 10000, | Multiple measurement (counting, until Status = STEP RDY) | | | | |
| <StopCond> | Description of parameters | Def. value | Def. unit | FW vers. | |
| NONE, | No stop condition set (no limit check) | NONE | – | | |
| <Stepmode> | Description of parameters | Def. value | Def. unit | FW vers. | |
| STEP | Interrupt measurement after each statistics cycle | NONE | – | V4.50 | |
| NONE | Continue measurement according to its rep. mode | | | | |
| Description of command | | | | | |
| This command determines the number of statistics cycles, the stop condition and the stepping mode for the measurement. | | | | | |
| Note: For READ commands (READ:...), the <Repetition> parameter has no effect; the measurement is always stopped after a single shot. | | | | | |

| CONFigure:THD:STEReo:HARMonics<nr> <Enable_1>, <Enable_2> | | | | Test Tones |
|--|--|------------|-----------|------------|
| <Enable_1> | Description of parameters | Def. value | Def. unit | FW vers. |
| ON OFF | Enable/disable harmonic <nr> = 2 ... 9 for the AF channel 1 signal (measured at AF 1 IN) | ON | – | V4.50 |
| <Enable_2> | Description of parameters | Def. value | Def. unit | FW vers. |
| ON OFF | Enable/disable harmonic <nr> = 2 ... 9 for the AF channel 2 signal (measured at AF 2 IN) | ON | – | V4.50 |
| Description of command | | | | |
| This command enables the harmonics no. 2 to 9 for the stereo THD calculation. The audio levels are measured for all harmonics below 21 kHz. The first harmonic frequency is always enabled: A query returns 1 (ON), a setting command causes an SCPI error message <i>Invalid Suffix</i> . | | | | |
| The command overwrites the CONFigure:THD:AF1Channel:HARMonics<nr> and CONFigure:THD:AF2Channel:HARMonics<nr> settings. | | | | |

| CONFigure:THD:STEReo:TDEFinition <Frequency_1>, <Level_1>, <Frequency_2>, <Level_2> | | | | Frequency d1, Analog Generator Level |
|---|--|------------|-----------|--------------------------------------|
| <Frequency_1> | Description of parameters | Def. value | Def. unit | FW Vers. |
| 500 Hz to 3000 Hz, | Frequency of AF generator for the AF channel 1 signal (routed to AF 1 OUT) | 1000 | Hz | V4.50 |
| <Level_1> | Description of parameters | Def. value | Def. unit | |
| 0.05 mV to 5.0 V | AF level for the AF channel 1 signal (routed to AF 1 OUT) | 0.01 | V | 0 |
| <Frequency_2> | Description of parameters | Def. value | Def. unit | FW Vers. |
| 500 Hz to 3000 Hz, | Frequency of AF generator for the AF channel 2 signal (routed to AF 2 OUT) | 1000 | Hz | V4.50 |
| <Level_2> | Description of parameters | Def. value | Def. unit | |
| 0.05 mV to 5.0 V | AF level for the AF channel 2 signal (routed to AF 2 OUT) | 0.01 | V | 0 |
| Description of command | | | | |
| This command configures the generator signals for the stereo THD measurement for test scenarios where an analog generator is used. Analog generator levels are specified in V. The first harmonic d1 is measured at the generator signal frequency. | | | | |
| The command overwrites the CONFigure:THD:AF1Channel:TDEFinition and CONFigure:THD:AF2Channel:TDEFinition settings. | | | | |

Results – Subsystem THD:…?

The following commands start the THD measurement (READ…) and return the results. They correspond to the various output elements in the measurement menu *THD*.

| Harmonic levels, single | | | | |
|---|---------------------------|------------|-----------|---|
| READ[:SCALar]:THD:STEReo:AF1Channel:HARMonic<nr>? | | | | |
| READ[:SCALar]:THD:STEReo:AF2Channel:HARMonic<nr>? | | | | |
| | | | | Start single shot measurement and return results ⇒ <i>RUN</i> |
| FETCH[:SCALar]:THD:STEReo:AF1Channel:HARMonic<nr>? | | | | |
| FETCH[:SCALar]:THD:STEReo:AF2Channel:HARMonic<nr>? | | | | |
| | | | | Read results (unsynchronized) ⇒ <i>RUN</i> |
| Returned values | Description of parameters | Def. value | Def. unit | FW vers. |
| -140.0 dB to +140.0 dB | AF level at harmonic <nr> | NAN | dB | V4.50 |
| Description of command | | | | |
| These commands are always queries. They return the audio levels at the first harmonic frequency d1 (<nr> = 1) and at the harmonic frequencies <nr> = 2 to 9. All results are normalized to level of the first harmonic, so the first result is always 0 dB. | | | | |

| Harmonics levels, single, both channels | | | | |
|---|-------------------------------------|------------|-----------|---|
| READ[:SCALar]:THD:STEReo:HARMonic<nr>? | | | | |
| FETCH[:SCALar]:THD:STEReo:HARMonic<nr>? | | | | |
| | | | | Start single shot measurement and return results ⇒ <i>RUN</i> |
| | | | | Read results (unsynchronized) ⇒ <i>RUN</i> |
| Returned values | Description of parameters | Def. value | Def. unit | FW vers. |
| -140.0 dB to +140.0 dB, | AF channel 1 level at harmonic <nr> | NAN | dB | V4.50 |
| -140.0 dB to +140.0 dB | AF channel 2 level at harmonic <nr> | NAN | dB | |
| Description of command | | | | |
| These commands are always queries. They return the audio levels at the first harmonic frequency d1 (<nr> = 1) and at the harmonic frequencies <nr> = 2 to 9. All results are normalized to level of the first harmonic, so the first result is always 0 dB, 0 dB. | | | | |

| Harmonics levels, all | | | | |
|--|--|------------|-----------|---|
| READ:ARRay:THD:STEReo:AF1Channel? | | | | |
| READ:ARRay:THD:STEReo:AF2Channel? | | | | |
| | | | | Start single shot measurement and return results ⇒ <i>RUN</i> |
| FETCH:ARRay:THD:STEReo:AF1Channel? | | | | |
| FETCH:ARRay:THD:STEReo:AF2Channel? | | | | |
| | | | | Read meas. results (unsynchronized) ⇒ <i>RUN</i> |
| Returned values | Description of parameters | Def. value | Def. unit | FW vers. |
| -140.0 dB to +140.0 dB, | AF Level[[1], 2 nd harmonic level | NAN | dB | V4.50 |
| ... | ... | ... | ... | |
| -140.0 dB to +140.0 dB | AF Level[[9], 9 th harmonic level | NAN | dB | |
| Description of command | | | | |
| These commands are always queries. They return the audio level for all harmonics d2 to d9. | | | | |

| Harmonics levels, all, both channels | | | | |
|--|---|------------|-----------|---|
| READ:ARRay:THD:STEReo? | | | | |
| FETCH:ARRay:THD:STEReo? | | | | |
| | | | | Start single shot measurement and return results ⇒ <i>RUN</i> |
| | | | | Read meas. results (unsynchronized) ⇒ <i>RUN</i> |
| Returned values | Description of parameters | Def. value | Def. unit | FW vers. |
| -140.0 dB to +140.0 dB, | AF Level[[1], 2 nd harmonic level in channel 1 | NAN | dB | V4.50 |
| ... | ... | ... | ... | |
| -140.0 dB to +140.0 dB, | AF Level[[9], 9 th harmonic level in channel 1 | NAN | dB | |
| -140.0 dB to +140.0 dB, | AF Level[[1], 2 nd harmonic level in channel 2 | NAN | dB | |
| ... | ... | ... | ... | |
| -140.0 dB to +140.0 dB | AF Level[[9], 9 th harmonic level in channel 2 | NAN | dB | |
| Description of command | | | | |
| These commands are always queries. They return the audio level for all harmonics d2 to d9. | | | | |

| READ[:SCALar]:THD:STEReo:AF1Channel:THD? | | THD results | | |
|---|---------------------------|--|--------------|----------|
| READ[:SCALar]:THD:STEReo:AF2Channel:THD? | | | | |
| | | Start single shot measurement and return results | ⇒ <i>RUN</i> | |
| FEtCh[:SCALar]:THD:STEReo:AF1Channel:THD? | | | | |
| FEtCh[:SCALar]:THD:STEReo:AF2Channel:THD? | | Read results (unsynchronized) | ⇒ <i>RUN</i> | |
| Returned values | Description of parameters | Def. value | Def. unit | FW vers. |
| 0 % to 100 %, | THD in percent | NAN | % | V4.50 |
| -140.0 dB to +0.0 dB | THD in dB | NAN | dB | |
| Description of command | | | | |
| These commands are always queries. They return the Total Harmonic Distortion (THD) as a percentage and as an equivalent dB-value. | | | | |

| | | THD results, both channels | | |
|---|---------------------------|--|--------------|----------|
| READ[:SCALar]:THD:STEReo:THD? | | Start single shot measurement and return results | ⇒ <i>RUN</i> | |
| FEtCh[:SCALar]:THD:STEReo:THD? | | Read results (unsynchronized) | ⇒ <i>RUN</i> | |
| Returned values | Description of parameters | Def. value | Def. unit | FW vers. |
| 0 % to 100 %, | THD in percent, channel 1 | NAN | % | V4.50 |
| -140.0 dB to +0.0 dB, | THD in dB, channel 1 | NAN | dB | |
| 0 % to 100 %, | THD in percent, channel 2 | NAN | % | |
| -140.0 dB to +0.0 dB | THD in dB, channel 2 | NAN | dB | |
| Description of command | | | | |
| These commands are always queries. They return the Total Harmonic Distortion (THD) as a percentage and as an equivalent dB-value. | | | | |

List of Commands

In the following, all remote-control commands of the R&S CMU base system and of function groups RF Non Signalling and Audio Non Signalling are listed with their parameters and page numbers. Generally, they are arranged alphabetically according to the **second** keyword of the command so that related commands belong to the same group. For a list of common commands see Table 6-1 in section Common Commands.

Table 6-1 List of remote-control commands: CMU base system

| Command | Parameters | Remarks | Page |
|--|---|------------|------|
| Subsystem COMMunicate (interface parameters) | | | |
| SYSTem:COMMunicate:GPIB[:SELF]:ADDRESS | 0 to 30 | with query | 6.16 |
| SYSTem:COMMunicate:SERial<1 2>:APPLication | – | query only | 6.16 |
| SYSTem:COMMunicate:SERial<1 2>:TRANsmit:PACE | XON ACK NONE | with query | 6.17 |
| SYSTem:COMMunicate:SERial<1 2>[:RECeive]:BAUD | 110 to 115200 | with query | 6.16 |
| SYSTem:COMMunicate:SERial<1 2>[:RECeive]:BITS | 7 8 | with query | 6.16 |
| SYSTem:COMMunicate:SERial<1 2>[:RECeive]:PARity[:TYPE] | NONE ODD EVEN | with query | 6.17 |
| SYSTem:COMMunicate:SERial<1 2>[:RECeive]:STOP | 1 2 | with query | 6.17 |
| Subsystem ERRor (error queue) | | | |
| SYSTem:ERRor? | | query only | 6.8 |
| *GTL (Go to Local) | | | |
| *GTL | – | no query | 6.25 |
| Subsystem GTRMode (go to remote) | | | |
| SYSTem:GTRMode:COMPAtible | ON OFF | with query | 6.25 |
| *LLO (local lockout) | | | |
| *LLO | TRUE FALSE | no query | 6.27 |
| Subsystem MISC (keyboard settings) | | | |
| SYSTem:MISC:KBEEp | ON OFF | with query | 6.19 |
| SYSTem:MISC:KEYBoard | US GR | with query | 6.19 |
| Subsystem MMEMory (mass memory) | | | |
| MMEMory:CDIRectory | <DirectoryName> | no query | 6.30 |
| MMEMory:COMMent | <Comment> | with query | 6.29 |
| MMEMory:COpy | <FileSource>, <msus1>, <FileDest>, <msus2> <FileSource>, <FileDest> | no query | 6.31 |
| MMEMory:DATA? | <FileName> ,<Data> | with query | 6.32 |
| MMEMory:DELete | <FileName> [,<msus>] | no query | 6.30 |
| MMEMory:DIRectory[:CURRent]? | <DirectoryName> | query only | 6.30 |
| MMEMory:INFO? | <FileName> [,<msus>] | query only | 6.29 |
| MMEMory:MKDir | <DirName> [,<msus>] | no query | 6.30 |
| MMEMory:MOVE | <FileSource>, <msus1>, <FileDest>, <msus2> | no query | 6.31 |

| Command | Parameters | Remarks | Page |
|--|--|------------|------|
| | <FileSource>, <FileDest> | | |
| MMEMory:MSIS | [<msus>] | with query | 6.29 |
| MMEMory:RECall:CURRent | <FileName> [,<msus>] | no query | 6.33 |
| MMEMory:RECall[:ALL] | <FileName> [,<msus>] | no query | 6.33 |
| MMEMory:REName | <FileSource>[,<msus1>], <FileDest> [,<msus2>] | no query | 6.31 |
| MMEMory:RMDir | <DirName> [,<msus>] | no query | 6.30 |
| MMEMory:SAVE:CURRent | <FileName> [,<msus>] | no query | 6.32 |
| MMEMory:SAVE[:ALL] | <FileName> [,<msus>] | no query | 6.32 |
| MMEMory:SCAN? | INT EXT, D , <DirectoryName1>,<Directory Name2>,.... ,F , <FileName1>,<FileName2>,... | query only | 6.31 |
| MMEMory:SAVE[:ALL] | <FileName> [,<msus>] | no query | 6.33 |
| MMEMory:SCAN? | INT EXT, D , <DirectoryName1>,<Directory Name2>,.... ,F , <FileName1>,<FileName2>,... | query only | 6.33 |
| Subsystem MQueue (measurement queue) | | | |
| SYSTem:MQueue[:COMPLete]:ITEM? | US GR | query only | 6.26 |
| SYSTem:MQueue[:COMPLete][:LIST]? | <Meas_Queue> | query only | 6.25 |
| Subsystem OPTions (options) | | | |
| SYSTem:OPTions:INFO? | | query only | 6.17 |
| SYSTem:OPTions? | | query only | 6.18 |
| Subsystem PRESet (partial or general reset) | | | |
| SYSTem:PRESet[:ALL] | | no query | 6.26 |
| SYSTem:RESet:CURRent | | no query | 6.27 |
| SYSTem:RESet[:ALL] | | no query | 6.27 |
| Subsystem REBoote (reboot) | | | |
| SYSTem:REBoot | – | no query | 6.8 |
| SYSTem:REBoot:ERRor? | ON OFF | no query | 6.9 |
| Subsystem REMote (remote control) | | | |
| SYSTem:REMOte:ADDRes:PRIMary | 0 to 30 | with query | 6.13 |
| SYSTem:REMOte:ADDRes:SECOndary | 1 to 29,<Remote-FGrp-Name> NONE | with query | 6.14 |
| SYSTem:REMOte:ADDRes:SECOndary:UNMap | – | no query | 6.14 |
| SYSTem:REMOte:FORMat:NUMeric | IEEE754 SCPI | with query | 6.15 |
| SYSTem:REMOte:FORMat:NUMeric | IEEE754 SCPI | with query | 6.15 |
| SYSTem:REMOte:RDMode | ON OFF | with query | 6.15 |
| SYSTem:REMOte:TPManagement | ON OFF | with query | 6.15 |
| *SEC | 1 to 29 | no query | 6.14 |
| System STATus (status reporting system) | | | |
| STATus:OPERation:CMU:ALL | 0 to 32767, ... , 0 to 32767 | query only | 6.11 |

| Command | Parameters | Remarks | Page |
|--|---|------------|------|
| STATus:OPERation:CMU:CLEar | – | no query | 6.11 |
| STATus:OPERation:CMU:SUM<nr>:CMU<nr_event>:ENABLE | 0 to 32767 | with query | 6.10 |
| STATus:OPERation:CMU:SUM<nr>:CMU<nr_event>[EVENT]? | | query only | 6.10 |
| STATus:OPERation:CMU:SUM<nr>:ENABLE | 0 to 32767 | with query | 6.10 |
| STATus:OPERation:CMU:SUM<nr>[EVENT]? | | query only | 6.10 |
| STATus:OPERation:ENABLE | 0 to 32767 | with query | 6.10 |
| STATus:OPERation:EVENT:SADDRESS? | <SecAddr>,<Fgrp> | query only | 6.12 |
| STATus:OPERation:SYMBOLic:ENABLE | <Event>{,<Event>} | with query | 6.12 |
| STATus:OPERation:SYMBOLic[EVENT]? | NONE <Event>{,<Event>} | query only | 6.12 |
| STATus:OPERation[EVENT]? | | query only | 6.9 |
| STATus:PRESet | – | no query | 6.11 |
| STATus:QUESTionable:ENABLE | 0 to 32767 | with query | 6.11 |
| STATus:QUESTionable[EVENT]? | | query only | 6.11 |
| Subsystem SYNChronize (reference frequency) | | | |
| CONFigure:SYNChronize:FREQuency:REFeRence | 10 kHz to 52 MHz | with query | 6.33 |
| [SENSe:]SYNChronize:FREQuency:REFeRence:LOCKed? | ON OFF | query only | 6.34 |
| CONFigure:SYNChronize:FREQuency:REFeRence:MODE | INTernal EXTernal | with query | 6.33 |
| SYSTEM (system parameters) | | | |
| SYSTEM:ERRor? | | query only | 6.8 |
| SYSTEM:NONVolatile:DISable | | no query | 6.8 |
| SYSTEM:OPTions:MEquipment? | | query only | 6.9 |
| SYSTEM:VERSion? | | query only | 6.8 |
| SYSTEM:[TIME:]DATE | YYYY,MM,DD | with query | 6.19 |
| SYSTEM:[TIME:]TIME | 0 to 23,0 to 59,0 to 59 | with query | 6.18 |
| SYSTEM:[TIME:]TZONE | -12 to +12,-59 to +59 | with query | 6.18 |
| Subsystem TCPip (TCP/IP Addressing) | | | |
| [SENSe:]IPADdress:FCODE? | <Failure Code> | query only | 6.23 |
| SYSTEM:TCPip:PRIMary:DEFault | ON OFF | with query | 6.20 |
| SYSTEM:TCPip:PRIMary:STATic:DGATeway | <Gateway 1>,<Gateway 2>,<Gateway 3>,<Gateway 4> | with query | 6.21 |
| SYSTEM:TCPip:PRIMary:STATic:IPADdress | <IP Address 1>,<IP Address 2>,<IP Address 3>,<IP Address 4> | with query | 6.20 |
| SYSTEM:TCPip:PRIMary:STATic:SMASK | <Subnet Mask 1>,<Subnet Mask 2>,<Subnet Mask 3>,<Subnet Mask 4> | with query | 6.20 |
| SYSTEM:TCPip:SECOndary:DEFault | ON OFF | with query | 6.21 |
| SYSTEM:TCPip:SECOndary:DYNamic:DGATeway? | <Gateway 1>,<Gateway 2>,<Gateway 3>,<Gateway 4> | query only | 6.24 |
| SYSTEM:TCPip:SECOndary:DYNamic:DNS? | <DNS 1>,<DNS 2>,<DNS 3>,<DNS 4> | query only | 6.23 |
| SYSTEM:TCPip:SECOndary:DYNamic:HNAME | <Hostname> | with query | 6.23 |
| SYSTEM:TCPip:SECOndary:DYNamic:IPADdress? | <IP Address 1>,<IP Address 2>,<IP Address 3>,<IP Address 4> | query only | 6.24 |
| SYSTEM:TCPip:SECOndary:DYNamic:SMASK? | <Subnet Mask 1>,<Subnet Mask 2>,<Subnet Mask 3>,<Subnet Mask 4> | query only | 6.24 |

| Command | Parameters | Remarks | Page |
|--|--|------------|------|
| | <Subnet Mask 4> | | |
| SYSTem:TCPIp:SECOndary:MODE | STAT DYN PEND UDEF | with query | 6.21 |
| SYSTem:TCPIp:SECOndary:STATic:DGATeway | <Gateway 1>, <Gateway 2>, <Gateway 3>, <Gateway 4> | with query | 6.22 |
| SYSTem:TCPIp:SECOndary:STATic:IPADdress | <IP Address 1>, <IP Address 2>, <IP Address 3>, <IP Address 4> | with query | 6.22 |
| SYSTem:TCPIp:SECOndary:STATic:SMASK | <Subnet Mask 1>, <Subnet Mask 2>, <Subnet Mask 3>, <Subnet Mask 4> | with query | 6.22 |
| TRACe (remote report) | | | |
| TRACe:REMote:MODE:DISPlay | ON OFF | - | 6.28 |
| TRACe:REMote:MODE:ERRor | ON OFF | - | 6.29 |
| TRACe:REMote:MODE:FILE | ON OFF | - | 6.28 |
| TRACe:REMote:MODE:OUTLines | 1 to 4 | - | 6.29 |
| TRACe:REMote:MODE:SRQ | ON OFF | - | 6.29 |
| Frequency-dependent user correction | | | |
| DEFault:USER:CORRection:LOSS | ON OFF | with query | 6.36 |
| SORT:USER:CORRection:LOSS:TABLE | - | with query | 6.37 |
| CONFIgure:USER:CORRection:LOSS:TABLE:ENABLE | ON OFF | with query | 6.36 |
| CONFIgure:USER:CORRection:LOSS:TABLE:LINE<nr>? | <Frequency>, <Att_RF1>, <Att_RF2>, <Att_RF3 OUT>, <Att_RF4 IN> | with query | 6.37 |
| CONFIgure:USER:CORRection:LOSS:TABLE? | <All values> | with query | 6.36 |
| WINDows (screensaver) | | | |
| DISPlay[:WINDow][:STATE]? | ON OFF | with query | 6.36 |

Table 6-2 List of remote-control commands: RF measurements

| Command | Parameters | Remarks | Page |
|---|-------------------------|------------|------|
| Subsystem CORRection:LOSS (Ext. Attenuation) | | | |
| [SENSe:]CORRection:LOSS:INPut<nr>[:MAGNitude] | -50 dB to 90 dB | with query | 6.56 |
| SOURce:CORRection:LOSS:INPut<nr>[:MAGNitude] | -50 dB to 90 dB | with query | 6.56 |
| [SENSe:]CORRection:LOSS:OUTPut<nr>:AUXTx:OLEVel[:MAGNitude] | -50 dB to 90 dB | with query | 6.57 |
| SOURce:CORRection:LOSS:OUTPut<nr>:AUXTx:OLEVel[:MAGNitude] | -50 dB to 90 dB | with query | 6.57 |
| [SENSe:]CORRection:LOSS:OUTPut<nr>:AUXTx[:MAGNitude] | -50 dB to 90 dB | with query | 6.57 |
| SOURce:CORRection:LOSS:OUTPut<nr>:AUXTx[:MAGNitude] | -50 dB to 90 dB | with query | 6.57 |
| [SENSe:]CORRection:LOSS:OUTPut<nr>[:TX][:MAGNitude] | -50 dB to 90 dB | with query | 6.56 |
| SOURce:CORRection:LOSS:OUTPut<nr>[:TX][:MAGNitude] | -50 dB to 90 dB | with query | 6.56 |
| Subsystem DM:CLOCK (Synchronization) | | | |
| SOURce:DM:CLOCK:FREQuency | 1.250 MHz to 40.000 MHz | with query | 6.58 |

| Command | Parameters | Remarks | Page |
|--|---|------------|------|
| SOURce:DM:CLOCK:STATe | ON OFF | with query | 6.58 |
| Subsystem INPut, OUTPut () | | | |
| INPut[:STATe] | RF1 RF2 RF4 | with query | 6.56 |
| OUTPut[:TX][:STATe] | RF1 RF2 RF3 | with query | 6.56 |
| OUTPut:AUXTx[:STATe] | ON OFF | with query | 6.57 |
| OUTPut:AUXTx:OLEVel[:STATe] | ON OFF | with query | 6.57 |
| Subsystem IQIF (I/Q-IF Signals) | | | |
| IQIF:DEFault | ON OFF | with query | 6.60 |
| CONFigure:IQIF:RXPath | BYP BYIQ XOIO IOIO IOXO | with query | 6.59 |
| CONFigure:IQIF:RXTXcombined | BYP BYIQ XOIO IOIO IOXO Fpat UDEF | with query | 6.59 |
| CONFigure:IQIF:TXPath | BYP BYIQ XOIO IOIO IOXO | with query | 6.59 |
| IQRecorder | | | |
| INITiate:IQRecorder | – | no query | 6.82 |
| ABORt:IQRecorder | – | no query | 6.82 |
| STOP:IQRecorder | – | no query | 6.82 |
| CONFigure:SUBarrays:IQRecorder | ALL ARITHmetical MINimum MAXimum IVAL,<Start>,<Samples>{,<Start>,<Samples>} | with query | 6.86 |
| DEFault:IQRecorder:CONTRol | ON OFF | with query | 6.85 |
| CONFigure:IQRecorder:CONTRol:CLENgth | 1 sample to 65536 samples | with query | 6.84 |
| CONFigure:IQRecorder:CONTRol:CTIMEout | 1/10 s to 60/10 s | with query | 6.84 |
| CONFigure:IQRecorder:CONTRol:FILTer | GAUS NYQ | with query | 6.83 |
| CONFigure:IQRecorder:CONTRol:GFILTer | F50k F100K F200K F300K F500K F1M | with query | 6.84 |
| CONFigure:IQRecorder:CONTRol:LFORmat | VOLT DBM | with query | 6.85 |
| CONFigure:IQRecorder:CONTRol:NFILTer | F50k F100K F200K F300K F500K F1M | with query | 6.84 |
| CONFigure:IQRecorder:CONTRol:RMODE | IQ PLW PLUW | with query | 6.85 |
| CONFigure:IQRecorder:CONTRol:TDELay | –64000 to +64000 | with query | 6.84 |
| CONFigure:IQRecorder:EREPorting | SRQ SOPC SRSQ OFF | with query | 6.82 |
| FETCh:IQRecorder:FSBW? | NYQ GAUS, <Sampling_Rate>, <Bandwidth> | query only | 6.83 |
| READ:ARRay:IQRecorder:I? | <Result> | query only | 6.88 |
| FETCh:ARRay:IQRecorder:I? | <Result> | query only | 6.88 |
| SAMPlE:ARRay:IQRecorder:I? | <Result> | query only | 6.88 |
| READ:SUBarrays:IQRecorder:I? | <Result> | query only | 6.91 |
| FETCh:SUBarrays:IQRecorder:I? | <Result> | query only | 6.91 |
| SAMPlE:SUBarrays:IQRecorder:I? | <Result> | query only | 6.91 |
| READ:BINary:ARRay:IQRecorder:I? | <Result> | query only | 6.96 |
| FETCh:BINary:ARRay:IQRecorder:I? | <Result> | query only | 6.96 |
| SAMPlE:BINary:ARRay:IQRecorder:I? | <Result> | query only | 6.96 |
| READ:ARRay:IQRecorder:IQ? | <Result> | query only | 6.89 |

| Command | Parameters | Remarks | Page |
|---------------------------------------|------------------------|------------|------|
| FETCh:ARRay:IQRecorder:IQ? | <Result> | query only | 6.89 |
| SAMPlE:ARRay:IQRecorder:IQ? | <Result> | query only | 6.89 |
| READ:SUBarrays:IQRecorder:IQ? | <Result> | query only | 6.92 |
| FETCh:SUBarrays:IQRecorder:IQ? | <Result> | query only | 6.92 |
| SAMPlE:SUBarrays:IQRecorder:IQ? | <Result> | query only | 6.92 |
| READ:BINary:ARRay:IQRecorder:IQ? | <Result> | query only | 6.97 |
| FETCh:BINary:ARRay:IQRecorder:IQ? | <Result> | query only | 6.97 |
| SAMPlE:BINary:ARRay:IQRecorder:IQ? | <Result> | query only | 6.97 |
| READ:ARRay:IQRecorder:LEVel? | <Result> | query only | 6.87 |
| FETCh:ARRay:IQRecorder:LEVel? | <Result> | query only | 6.87 |
| SAMPlE:ARRay:IQRecorder:LEVel? | <Result> | query only | 6.87 |
| READ:SUBarrays:IQRecorder:LEVel? | <Result> | query only | 6.90 |
| FETCh:SUBarrays:IQRecorder:LEVel? | <Result> | query only | 6.90 |
| SAMPlE:SUBarrays:IQRecorder:LEVel? | <Result> | query only | 6.90 |
| READ:BINary:ARRay:IQRecorder:LEVel? | <Result> | query only | 6.94 |
| FETCh:BINary:ARRay:IQRecorder:LEVel? | <Result> | query only | 6.94 |
| SAMPlE:BINary:ARRay:IQRecorder:LEVel? | <Result> | query only | 6.94 |
| READ:ARRay:IQRecorder:PHASe? | <Result> | query only | 6.87 |
| FETCh:ARRay:IQRecorder:PHASe? | <Result> | query only | 6.87 |
| SAMPlE:ARRay:IQRecorder:PHASe? | <Result> | query only | 6.87 |
| READ:SUBarrays:IQRecorder:PHASe? | <Result> | query only | 6.90 |
| FETCh:SUBarrays:IQRecorder:PHASe? | <Result> | query only | 6.90 |
| SAMPlE:SUBarrays:IQRecorder:PHASe? | <Result> | query only | 6.90 |
| READ:BINary:ARRay:IQRecorder:PHASe? | <Result> | query only | 6.93 |
| FETCh:BINary:ARRay:IQRecorder:PHASe? | <Result> | query only | 6.93 |
| SAMPlE:BINary:ARRay:IQRecorder:PHASe? | <Result> | query only | 6.93 |
| READ:ARRay:IQRecorder:PL? | <Result> | query only | 6.88 |
| FETCh:ARRay:IQRecorder:PL? | <Result> | query only | 6.88 |
| SAMPlE:ARRay:IQRecorder:PL? | <Result> | query only | 6.88 |
| READ:SUBarrays:IQRecorder:PL? | <Result> | query only | 6.91 |
| FETCh:SUBarrays:IQRecorder:PL? | <Result> | query only | 6.91 |
| SAMPlE:SUBarrays:IQRecorder:PL? | <Result> | query only | 6.91 |
| READ:BINary:ARRay:IQRecorder:PL? | <Result> | query only | 6.95 |
| FETCh:BINary:ARRay:IQRecorder:PL? | <Result> | query only | 6.95 |
| SAMPlE:BINary:ARRay:IQRecorder:PL? | <Result> | query only | 6.95 |
| READ:ARRay:IQRecorder:Q? | <Result> | query only | 6.89 |
| FETCh:ARRay:IQRecorder:Q? | <Result> | query only | 6.89 |
| SAMPlE:ARRay:IQRecorder:Q? | <Result> | query only | 6.89 |
| READ:SUBarrays:IQRecorder:Q? | <Result> | query only | 6.92 |
| FETCh:SUBarrays:IQRecorder:Q? | <Result> | query only | 6.92 |
| SAMPlE:SUBarrays:IQRecorder:Q? | <Result> | query only | 6.92 |
| READ:BINary:ARRay:IQRecorder:Q? | <Result> | query only | 6.96 |
| FETCh:BINary:ARRay:IQRecorder:Q? | <Result> | query only | 6.96 |
| SAMPlE:BINary:ARRay:IQRecorder:Q? | <Result> | query only | 6.96 |
| FETCh:IQRecorder:STATus? | OFF RUN STOP ERR | query only | 6.82 |

| Command | Parameters | Remarks | Page |
|---|--|------------|-------|
| | STEP RDY, 1 to 10000 NONE , 1 to 1000 NONE | | |
| Subsystem IQSLot (I/Q vs. Slot) | | | |
| INITiate:IQSLot | – | no query | 6.98 |
| ABORt:IQSLot | – | no query | 6.98 |
| STOP:IQSLot | – | no query | 6.98 |
| CONTinue:IQSLot | – | no query | 6.98 |
| CONFigure:SUBarrays:IQSLot | ALL ARITHmetical MINimum MAXimum IVAL XMINimum XMAXimum PAVG,<Start>,<Samples>{,<Start>,<Samples>} | with query | 6.103 |
| DEFault:IQSLot:CONTRol | ON OFF | with query | 6.100 |
| CONFigure:IQSLot:CONTRol:CTIMEout | 0.0 s to 60.0 | with query | 6.101 |
| CONFigure:IQSLot:CONTRol:FELimit | –200 dB to –30 dB | with query | 6.101 |
| CONFigure:IQSLot:CONTRol:MLENght | 128 µs to 8192 µs | with query | 6.101 |
| CONFigure:IQSLot:CONTRol:NOSTeps | 1 to 1000 | with query | 6.100 |
| CONFigure:IQSLot:CONTRol:NOSubsweeps | 1 to 20 | with query | 6.100 |
| CONFigure:IQSLot:CONTRol:REPetition | CONTinuous SINGleshot 1 to 10000, NONE,STEP NONE | with query | 6.100 |
| CONFigure:IQSLot:CONTRol:SELECTION | IQ LP | with query | 6.102 |
| CONFigure:IQSLot:CONTRol:SELENght | 128 µs to 16384 µs | with query | 6.101 |
| CONFigure:IQSLot:CONTRol:TOFFset | 0 µs to 32768 µs | with query | 6.101 |
| CONFigure:IQSLot:EREPorting | SRQ SOPC SRSQ OFF | with query | 6.98 |
| FETCh[:SCALar]:IQSLot:I:FREQuency:OFFSet? | –30000 Hz to +30000 Hz | query only | 6.103 |
| READ:ARRay:IQSLot:I? | –128.0 dBm to +48.0 dBm | query only | 6.104 |
| FETCh:ARRay:IQSLot:I? | –128.0 dBm to +48.0 dBm | query only | 6.104 |
| SAMPle:ARRay:IQSLot:I? | –128.0 dBm to +48.0 dBm | query only | 6.104 |
| READ:SUBarrays:IQSLot:I? | –128.0 dBm to +48.0 dBm | query only | 6.105 |
| FETCh:SUBarrays:IQSLot:I? | –128.0 dBm to +48.0 dBm | query only | 6.105 |
| SAMPle:SUBarrays:IQSLot:I? | –128.0 dBm to +48.0 dBm | query only | 6.105 |
| READ:ARRay:IQSLot:LEVel? | –128.0 dBm to +48.0 dBm | query only | 6.104 |
| FETCh:ARRay:IQSLot:LEVel? | –128.0 dBm to +48.0 dBm | query only | 6.104 |
| SAMPle:ARRay:IQSLot:LEVel? | –128.0 dBm to +48.0 dBm | query only | 6.104 |
| READ:SUBarrays:IQSLot:LEVel? | –128.0 dBm to +48.0 dBm | query only | 6.105 |
| FETCh:SUBarrays:IQSLot:LEVel? | –128.0 dBm to +48.0 dBm | query only | 6.105 |
| SAMPle:SUBarrays:IQSLot:LEVel? | –128.0 dBm to +48.0 dBm | query only | 6.105 |
| READ:ARRay:IQSLot:PHASe? | –128.0 dBm to +48.0 dBm | query only | 6.104 |
| FETCh:ARRay:IQSLot:PHASe? | –128.0 dBm to +48.0 dBm | query only | 6.104 |
| SAMPle:ARRay:IQSLot:PHASe? | –128.0 dBm to +48.0 dBm | query only | 6.104 |
| READ:SUBarrays:IQSLot:PHASe? | –128.0 dBm to +48.0 dBm | query only | 6.105 |
| FETCh:SUBarrays:IQSLot:PHASe? | –128.0 dBm to +48.0 dBm | query only | 6.105 |
| SAMPle:SUBarrays:IQSLot:PHASe? | –128.0 dBm to +48.0 dBm | query only | 6.105 |
| READ:ARRay:IQSLot:Q? | –128.0 dBm to +48.0 dBm | query only | 6.104 |
| FETCh:ARRay:IQSLot:Q? | –128.0 dBm to +48.0 dBm | query only | 6.104 |
| SAMPle:ARRay:IQSLot:Q? | –128.0 dBm to +48.0 dBm | query only | 6.104 |

| Command | Parameters | Remarks | Page |
|--|---|---|-------|
| READ:SUBarrays:IQSLot:Q? | -128.0 dBm to +48.0 dBm | query only | 6.105 |
| FETCh:SUBarrays:IQSLot:Q? | -128.0 dBm to +48.0 dBm | query only | 6.105 |
| SAMPlE:SUBarrays:IQSLot:Q? | -128.0 dBm to +48.0 dBm | query only | 6.105 |
| FETCh:IQSLot:STATus? | OFF RUN STOP ERR STEP RDY, 0 to 10000 NONE, 0 to 1000 NONE | query only | 6.98 |
| Subsystem LEVel (Input Level) | | | |
| [SENSe:]LEVel:ATTenuation | NORMal LNOise LDISTortion | with query | 6.40 |
| [SENSe:]LEVel:DEFault | ON OFF | with query | 6.41 |
| [SENSe:]LEVel:MAXimum | -54 dBm to +39 dBm | depending on RF connector | 6.40 |
| [SENSe:]LEVel:MODE | MANual AUTO | with query | 6.40 |
| [SENSe:]LEVel:REFerence | -100 dBm to +53 dBm | depending on input and ext. attenuation set | 6.41 |
| Save/Recall of settings | | | |
| MMEMory:RECall:CURRent | <FileName> [,<msus>] | no query | 6.38 |
| MMEMory:SAVE:CURRent | <FileName> [,<msus>] | no query | 6.37 |
| NPOWer (narrow-band power) | | | |
| INITiate:NPOWer | - | no query | 6.78 |
| ABORt:NPOWer | - | no query | 6.78 |
| STOP:NPOWer | - | no query | 6.78 |
| CONTinue:NPOWer | - | no query | 6.78 |
| [SENSe:]NPOWer:BWIDth[:RESolution] | 10 Hz to 1 MHz | with query | 6.80 |
| CONFigure:NPOWer:CONTRol | 1 to 1000 NONE,CONTInuous SINGleshot 1 ... 10000, SONerror NONE,STEP NONE | with query | 6.79 |
| CONFigure:NPOWer:CONTRol:REPetition | CONTInuous SINGleshot 1 ... 10000, SONerror NONE,STEP NONE | with query | 6.80 |
| CONFigure:NPOWer:CONTRol:STATistics | 1 to 1000 NONE | with query | 6.80 |
| CONFigure:NPOWer:EREPorting | SRQ SOPC SRSQ OFF | with query | 6.78 |
| FETCh:NPOWer:STATus? | OFF RUN STOP ERR STEP RDY, 1 to 10000 NONE, 1 to 1000 NONE | query only | 6.79 |
| READ[:SCALar]:NPOWer? | -30 dBm to +30 dBm | query only | 6.81 |
| FETCh[:SCALar]:NPOWer? | -30 dBm to +30 dBm | query only | 6.81 |
| SAMPlE[:SCALar]:NPOWer? | -30 dBm to +30 dBm | query only | 6.81 |
| System STATus:OPERation (symbolic status register evaluation) | | | |
| STATus:OPERation:SYMBOLic:ENABle | <Event>{,<Event>} | with query | 6.38 |
| STATus:OPERation:SYMBOLic[:EVENT]? | NONE <Event>{,<Event>} | query only | 6.39 |
| Subsystem OPTions (option info) | | | |
| SYSTem:OPTions:INFO:CURRent? | | query only | 6.37 |

| Command | Parameters | Remarks | Page |
|--|--|-----------------------|------|
| POWer measurements | | | |
| INITiate:POWer | – | no query | 6.61 |
| ABORt:POWer | – | no query | 6.61 |
| STOP:POWer | – | no query | 6.61 |
| CONTInue:POWer | – | no query | 6.61 |
| CONFIgure:SUBArrays:POWer | ALL ARITHmetical MINimum MAXimum IVAL XMINimum XMAXimum PAVG, <Start>, <Samples>{, <Start>, <Samples>} | with query | 6.65 |
| READ:ARRay:POWer:AVERAge? | –128.0 dBm to +48.0 dBm | query only | 6.66 |
| FETCh:ARRay:POWer:AVERAge? | –128.0 dBm to +48.0 dBm | query only | 6.66 |
| SAMPlE:ARRay:POWer:AVERAge? | –128.0 dBm to +48.0 dBm | query only | 6.66 |
| READ:SUBArrays:POWer:AVERAge? | –128.0 dBm to +48.0 dBm | query only | 6.67 |
| FETCh:SUBArrays:POWer:AVERAge? | –128.0 dBm to +48.0 dBm | query only | 6.67 |
| SAMPlE:SUBArrays:POWer:AVERAge? | –128.0 dBm to +48.0 dBm | query only | 6.67 |
| CONFIgure:POWer:CONTRol | SCALAR ARRAY | with query | 6.62 |
| DISPlay:POWer:CONTRol:GRID | ON OFF | with query | 6.62 |
| CONFIgure:POWer:CONTRol:REPetition | CONTInuous SINGleshot 1 to 10000, NONE, STEP NONE | with query | 6.62 |
| CONFIgure:POWer:CONTRol:TIMEout | 1 s to 60 s | with query | 6.64 |
| CONFIgure:POWer:EREPorting | SRQ SOPC SRSQ OFF | with query | 6.61 |
| [SENSe:]POWer:FREQuency:BANDwidth[:RESolution] | 10 Hz to 1 MHz | with query | 6.63 |
| [SENSe:]POWer:FREQuency:BWIDth[:RESolution] | 10 Hz to 1 MHz | with query | 6.63 |
| [SENSe:]POWer:FREQuency:CENTer | 10 kHz to 2.7 GHz | with query | 6.63 |
| [SENSe:]POWer:LEVel:RANGE | 10.0 dB to 100.0 dB | with query | 6.63 |
| READ:ARRay:POWer:MAXimum? | –128.0 dBm to +48.0 dBm | query only | 6.66 |
| FETCh:ARRay:POWer:MAXimum? | –128.0 dBm to +48.0 dBm | query only | 6.66 |
| SAMPlE:ARRay:POWer:MAXimum? | –128.0 dBm to +48.0 dBm | query only | 6.66 |
| READ:SUBArrays:POWer:MAXimum? | –128.0 dBm to +48.0 dBm | query only | 6.67 |
| FETCh:SUBArrays:POWer:MAXimum? | –128.0 dBm to +48.0 dBm | query only | 6.67 |
| SAMPlE:SUBArrays:POWer:MAXimum? | –128.0 dBm to +48.0 dBm | query only | 6.67 |
| READ:ARRay:POWer:MINimum? | –128.0 dBm to +48.0 dBm | query only | 6.66 |
| READ:ARRay:POWer:MINimum? | –128.0 dBm to +48.0 dBm | query only | 6.66 |
| FETCh:ARRay:POWer:MINimum? | –128.0 dBm to +48.0 dBm | query only | 6.66 |
| FETCh:ARRay:POWer:MINimum? | –128.0 dBm to +48.0 dBm | query only | 6.66 |
| SAMPlE:ARRay:POWer:MINimum? | –128.0 dBm to +48.0 dBm | query only | 6.66 |
| READ:SUBArrays:POWer:MINimum? | –128.0 dBm to +48.0 dBm | query only | 6.67 |
| READ:SUBArrays:POWer:MINimum? | –128.0 dBm to +48.0 dBm | query only | 6.67 |
| FETCh:SUBArrays:POWer:MINimum? | –128.0 dBm to +48.0 dBm | query only | 6.67 |
| FETCh:SUBArrays:POWer:MINimum? | –128.0 dBm to +48.0 dBm | query only | 6.67 |
| SAMPlE:SUBArrays:POWer:MINimum? | –128.0 dBm to +48.0 dBm | query only | 6.67 |
| FETCh:POWer:STATus? | OFF RUN STOP ERR STEP RDY, 0 to 10000 NONE, 0 to 1000 NONE | query only | 6.61 |
| [SENSe:]POWer:TIME:DELay | -1000.0 μ s to +1000.0 μ s | depending on span and | 6.64 |

| Command | Parameters | Remarks | Page |
|---|---|------------------------|------|
| | | bandwidth | |
| [SENSe:]POWer:TIME:SPAN | 10 μ s to 10 s | depending on bandwidth | 6.64 |
| READ:ARRAy:POWer[:CURRent]? | -128.0 dBm to +48.0 dBm | query only | 6.66 |
| FETCh:ARRAy:POWer[:CURRent]? | -128.0 dBm to +48.0 dBm | query only | 6.66 |
| SAMPlE:ARRAy:POWer[:CURRent]? | -128.0 dBm to +48.0 dBm | query only | 6.66 |
| READ:SUBArRays:POWer[:CURRent]? | -128.0 dBm to +48.0 dBm | query only | 6.67 |
| FETCh:SUBArRays:POWer[:CURRent]? | -128.0 dBm to +48.0 dBm | query only | 6.67 |
| SAMPlE:SUBArRays:POWer[:CURRent]? | -128.0 dBm to +48.0 dBm | query only | 6.67 |
| Subsystem RESet (partial reset) | | | |
| SYSTem:RESet:CURRent | | no query | 6.38 |
| RF Analyzer (RFANalyzer) | | | |
| INITiate:RFANalyzer | - | no query | 6.43 |
| ABORt:RFANalyzer | - | no query | 6.43 |
| STOP:RFANalyzer | - | no query | 6.43 |
| CONTInue:RFANalyzer | - | no query | 6.43 |
| [SENSe:]RFANalyzer:BANDwidth[:RESolution] | 10 Hz to 1 MHz WIDE WIDE | with query | 6.43 |
| [SENSe:]RFANalyzer:BWIDTh[:RESolution] | 10 Hz to 1MHz WIDE | with query | 6.43 |
| CONFIgure:RFANalyzer:CONTRol:REPetition | CONTInuous SINGleshot 1 to 10000, NONE,STEP NONE | with query | 6.44 |
| CONFIgure:RFANalyzer:EREPorting | SRQ SOPC SRSQ OFF | with query | 6.43 |
| [SENSe:]RFANalyzer:FREQUency | 50 kHz to 2.7 GHz | with query | 6.43 |
| CONFIgure:RFANalyzer:POWer:RTIME | 0 to xxx | with query | 6.44 |
| READ[:SCALar]:RFANalyzer:POWer? | -120.0 dBm to +47.0 dBm | query only | 6.45 |
| FETCh[:SCALar]:RFANalyzer:POWer? | -120.0 dBm to +47.0 dBm | query only | 6.45 |
| SAMPlE[:SCALar]:RFANalyzer:POWer? | -120.0 dBm to +47.0 dBm | query only | 6.45 |
| FETCh:RFANalyzer:STATus? | OFF RUN STOP ERR STEP RDY, 0 to 10000 NONE , 0 to 1000 NONE | query only | 6.44 |
| RF Generator | | | |
| DEFault:RFGenerator | ON OFF | with query | 6.45 |
| INITiate:RFGenerator | - | no query | 6.46 |
| ABORt:RFGenerator | - | no query | 6.46 |
| INITiate:RFGenerator | - | no query | 6.51 |
| ABORt:RFGenerator | - | no query | 6.51 |
| DEFault:RFGenerator:AUXTx | ON OFF | with query | 6.51 |
| SOURce:RFGenerator:AUXTx:FREQUency | 350 MHz to 550 MHz 700 MHz to 1100 MHz 1400 MHz to 2200 MHz | with query | 6.53 |
| SOURce:RFGenerator:AUXTx:FREQUency | 350 MHz to 550 MHz 700 MHz to 1100 MHz 1400 MHz to 2200 MHz | with query | 6.53 |
| SOURce:RFGenerator:AUXTx:LEVel | -122.0 dBm to + -52.0 dBm | restricted to RF1 / 2 | 6.52 |
| SOURce:RFGenerator:AUXTx:LEVel:P<nr> | -122.0 dBm to + -52.0 dBm | restricted to | 6.52 |

| Command | Parameters | Remarks | Page |
|---|--|---------------------------|------|
| | | RF1 / 2 | |
| SOURce:RFGenerator:AUXTx:OLEVel | -110.0 dBm to + +9.0 dBm | with query | 6.52 |
| SOURce:RFGenerator:AUXTx:PATH? | P1 P2 | with query | 6.51 |
| FETCh:RFGenerator:AUXTx:STATus? | OFF RUN ERR | query only | 6.51 |
| SOURce:RFGenerator:BANDwidth | OFF F30Khz F300khz | with query | 6.50 |
| SOURce:RFGenerator:BWIDth | <Bandwidth> | with query | 6.50 |
| SOURce:RFGenerator:FHOPping:FREQuency | 100.0 kHz to 2.7 GHz | with query | 6.49 |
| SOURce:RFGenerator:FHOPping:FREQuency:MODE | ABSolute RELative | with query | 6.49 |
| SOURce:RFGenerator:FHOPping:STATe | OFF ON | with query | 6.49 |
| DEFault:RFGenerator:GLISmode | ON OFF | with query | 6.53 |
| INITiate:RFGenerator::GLISmode | - | no query | 6.53 |
| ABORt:RFGenerator:GLISmode:DEFault | ON OFF | with query | 6.53 |
| SOURce:RFGenerator:GLISmode:DWELltime[?] | ON OFF | with query | 6.54 |
| FETCh[:SCALar]:RFGenerator:GLISmode:EOList? | OFF ON | query only | 6.54 |
| SOURce:RFGenerator:GLISmode:FREQuency[500][?] | 100 kHz to 2700 MHz | with query | 6.55 |
| SOURce:RFGenerator:GLISmode:PLEVel[500][?] | -137 dBm to -10 dBm | with query | 6.55 |
| FETCh[:SCALar]:RFGenerator:GLISmode:STATus? | OFF RUN STOP RDY STEP ERR | query only | 6.54 |
| SOURce:RFGenerator:GLISmode:STEPs[?] | 1 to 500 | with query | 6.54 |
| SOURce:RFGenerator:LSMode:STATe | OFF ON | with query | 6.50 |
| SOURce:RFGenerator:MODulation | OFF SSB AM FM | with query | 6.47 |
| SOURce:RFGenerator:MODulation:FM:DEViation | 0 Hz to +500.000 kHz | with query | 6.48 |
| SOURce:RFGenerator:MODulation:FM:FREQuency | 1 Hz to +50.000 kHz | with query | 6.48 |
| SOURce:RFGenerator:MODulation:FMSTereo:AUDio:DEViation | 0 Hz to 100 000 Hz | with query | 6.48 |
| SOURce:RFGenerator:MODulation:FMSTereo:AUDio:FREQuency? | 1 000 Hz to 100 000 Hz | with query | 6.48 |
| SOURce:RFGenerator:MODulation:FMSTereo:AUDio:MAPPING | MONO LEFT RIGHT | with query | 6.49 |
| SOURce:RFGenerator:MODulation:FMSTereo:PILot:DEViation | 0 Hz to 100 000 Hz | with query | 6.48 |
| SOURce:RFGenerator:MODulation:FMSTereo:PILot:FREQuency? | 19 000 | query only | 6.48 |
| SOURce:RFGenerator:MODulation:SSB:FREQuency | -300 kHz to +300 kHz | with query | 6.47 |
| SOURce:RFGenerator:MODulation[:AM]:INDEX | 0% to 100% | with query | 6.47 |
| SOURce:RFGenerator:PULSe:STATe | OFF ON | with query | 6.50 |
| DEFault:RFGenerator:TX | ON OFF | with query | 6.45 |
| SOURce:RFGenerator[:TX]:FREQuency | 100 kHz to 2.7 GHz | with query | 6.46 |
| SOURce:RFGenerator[:TX]:LEVel | -137.0 to +13.0 dBm | depending on RF connector | 6.46 |
| FETCh:RFGenerator[:TX]:STATus? | OFF RUN ERR | query only | 6.46 |
| SPECTrum measurements | | | |
| INITiate:SPECTrum | - | no query | 6.68 |
| ABORt:SPECTrum | - | no query | 6.68 |
| STOP:SPECTrum | - | no query | 6.68 |
| CONTInue:SPECTrum | - | no query | 6.68 |
| CONFigure:SUBarrays:SPECTrum | ALL ARITHmetical MINimum MAXimum IVAL XMINimum XMAXimum PAVG,<Start>,<Samples>{,<S | with query | 6.72 |

| Command | Parameters | Remarks | Page |
|---|--|------------|------|
| | start>,<Samples>} | | |
| READ:ARRay:SPECtrum:AVERage? | -128.0 dBm to +48.0 dBm | query only | 6.74 |
| FETCH:ARRay:SPECtrum:AVERage? | -128.0 dBm to +48.0 dBm | query only | 6.74 |
| SAMPLE:ARRay:SPECtrum:AVERage? | -128.0 dBm to +48.0 dBm | query only | 6.74 |
| READ:SUBarrays:SPECtrum:AVERage? | -128.0 dBm to +48.0 dBm | query only | 6.75 |
| FETCH:SUBarrays:SPECtrum:AVERage? | -128.0 dBm to +48.0 dBm | query only | 6.75 |
| SAMPLE:SUBarrays:SPECtrum:AVERage? | -128.0 dBm to +48.0 dBm | query only | 6.75 |
| CONFigure:SPECtrum:CONTRol | SCALAR ARRAY, 1 to 1000 NONE | with query | 6.69 |
| DISPlay:SPECtrum:CONTRol:GRID | ON OFF | with query | 6.70 |
| CONFigure:SPECtrum:CONTRol:REPetition | CONTinuous SINGleshot 1 to 10000, NONE, STEP NONE | with query | 6.70 |
| [SENSe:]SPECtrum:DETEctor | PEAK RMS | with query | 6.69 |
| CONFigure:SPECtrum:EREPorting | SRQ SOPC SRSQ OFF | with query | 6.68 |
| [SENSe:]SPECtrum:FREQuency:BANDwidth[:RESolution] | 10 Hz to 1 MHz AUTO | with query | 6.71 |
| [SENSe:]SPECtrum:FREQuency:BWIDth[:RESolution] | 10 Hz to 1 MHz AUTO | with query | 6.71 |
| [SENSe:]SPECtrum:FREQuency:CENTer | 10.000005 MHz to 2.699999995 GHz | with query | 6.70 |
| [SENSe:]SPECtrum:FREQuency:SPAN | 0.00001 MHz to 2.699999999 GHz | with query | 6.70 |
| [SENSe:]SPECtrum:FREQuency:START | 10 MHz to 2.699999999 GHz | with query | 6.70 |
| [SENSe:]SPECtrum:FREQuency:STOP | 10.00001 MHz to 2.7 GHz | with query | 6.70 |
| [SENSe:]SPECtrum:LEVel:RANGE | 10 dB to 100 dB | with query | 6.71 |
| FETCH:SPECtrum:MARKer:ABSolute? | | query only | 6.73 |
| FETCH:SPECtrum:MARKer:PEAK? | | query only | 6.73 |
| FETCH:SPECtrum:MARKer:RELative? | | query only | 6.73 |
| READ:ARRay:SPECtrum:MAXimum? | -128.0 dBm to +48.0 dBm | query only | 6.74 |
| FETCH:ARRay:SPECtrum:MAXimum? | -128.0 dBm to +48.0 dBm | query only | 6.74 |
| SAMPLE:ARRay:SPECtrum:MAXimum? | -128.0 dBm to +48.0 dBm | query only | 6.74 |
| READ:SUBarrays:SPECtrum:MAXimum? | -128.0 dBm to +48.0 dBm | query only | 6.75 |
| FETCH:SUBarrays:SPECtrum:MAXimum? | -128.0 dBm to +48.0 dBm | query only | 6.75 |
| SAMPLE:SUBarrays:SPECtrum:MAXimum? | -128.0 dBm to +48.0 dBm | query only | 6.75 |
| READ:ARRay:SPECtrum:MINimum? | -128.0 dBm to +48.0 dBm | query only | 6.74 |
| READ:ARRay:SPECtrum:MINimum? | -128.0 dBm to +48.0 dBm | query only | 6.74 |
| FETCH:ARRay:SPECtrum:MINimum? | -128.0 dBm to +48.0 dBm | query only | 6.74 |
| FETCH:ARRay:SPECtrum:MINimum? | -128.0 dBm to +48.0 dBm | query only | 6.74 |
| SAMPLE:ARRay:SPECtrum:MINimum? | -128.0 dBm to +48.0 dBm | query only | 6.74 |
| READ:SUBarrays:SPECtrum:MINimum? | -128.0 dBm to +48.0 dBm | query only | 6.75 |
| READ:SUBarrays:SPECtrum:MINimum? | -128.0 dBm to +48.0 dBm | query only | 6.75 |
| FETCH:SUBarrays:SPECtrum:MINimum? | -128.0 dBm to +48.0 dBm | query only | 6.75 |
| FETCH:SUBarrays:SPECtrum:MINimum? | -128.0 dBm to +48.0 dBm | query only | 6.75 |
| SAMPLE:SUBarrays:SPECtrum:MINimum? | -128.0 dBm to +48.0 dBm | query only | 6.75 |
| FETCH:SPECtrum:STATus? | OFF RUN STOP ERR STEP RDY, 0 to 10000 NONE, 0 to 1000 NONE | query only | 6.69 |
| READ:ARRay:SPECtrum[:CURRent]? | -128.0 dBm to +48.0 dBm | query only | 6.74 |
| FETCH:ARRay:SPECtrum[:CURRent]? | -128.0 dBm to +48.0 dBm | query only | 6.74 |

| Command | Parameters | Remarks | Page |
|--|---|------------|------|
| SAMPlE:ARRAy:SPECTrum[:CURRent]? | -128.0 dBm to +48.0 dBm | query only | 6.74 |
| READ:SUBArrays:SPECTrum[:CURRent]? | -128.0 dBm to +48.0 dBm | query only | 6.75 |
| FETCh:SUBArrays:SPECTrum[:CURRent]? | -128.0 dBm to +48.0 dBm | query only | 6.75 |
| SAMPlE:SUBArrays:SPECTrum[:CURRent]? | -128.0 dBm to +48.0 dBm | query only | 6.75 |
| Subsystem TRIGger | | | |
| TRIGger[:SEQuence]:DEFault | ON OFF | with query | 6.42 |
| TRIGger[:SEQuence]:MTGap[?] | 1 µs to 1000 µs OFF | with query | 6.42 |
| TRIGger[:SEQuence]:SLOPe | POSitive NEGative | with query | 6.42 |
| TRIGger[:SEQuence]:SOURce | IMMediate RFPower IFPower EXTern | with query | 6.41 |
| TRIGger[:SEQuence]:SOURce:EXTernal | PIN6 PIN7 PIN8 | with query | 6.42 |
| TRIGger[:SEQuence]:THReshold:IFPower | <Threshold> | with query | 6.42 |
| TRIGger[:SEQuence]:THReshold:RFPower | LOW MEDium HIGH | with query | 6.41 |
| Subsystem WPOWer (wideband power) | | | |
| INITiate:WPOWer | - | no query | 6.76 |
| ABORt:WPOWer | - | no query | 6.76 |
| STOP:WPOWer | - | no query | 6.76 |
| CONTInue:WPOWer | - | no query | 6.76 |
| CONFigure:WPOWer:CONTRol:REPetition | CONTInuous SINGleshot 1 ... 10000, SONerror NONE, STEP NONE | with query | 6.77 |
| CONFigure:WPOWer:EREPorting | SRQ SOPC SRSQ OFF | with query | 6.76 |
| FETCh:WPOWer:STATus? | OFF RUN STOP ERR STEP RDY, 1 ... 10000 NONE | query only | 6.76 |
| READ[:SCALAr]:WPOWer? | <Result> | query only | 6.77 |
| FETCh[:SCALAr]:WPOWer? | <Result> | query only | 6.77 |
| SAMPlE[:SCALAr]:WPOWer? | <Result> | query only | 6.77 |

Table 6-3 List of remote-control commands: Audio Measurements

| Command | Parameters | Remarks | Page |
|---|--|------------|-------|
| Subsystem AFANalyzer | | | |
| INITiate:AFANalyzer:SECondary | - | no query | 6.108 |
| STOP:AFANalyzer:SECondary | - | no query | 6.108 |
| STOP:AFANalyzer:SECondary | - | no query | 6.108 |
| ABORt:AFANalyzer:SECondary | - | no query | 6.108 |
| CONTInue:AFANalyzer:SECondary | - | no query | 6.108 |
| CONFigure:AFANalyzer:SECondary:CONTRol:COUPling | AC DC | with query | 6.110 |
| CONFigure:AFANalyzer:SECondary:CONTRol:DISToRtion[:FREQuency] | 100 Hz to 21000 Hz | with query | 6.110 |
| CONFigure:AFANalyzer:SECondary:CONTRol:REPetition | CONTInuous SINGleshot 1 to 10000, SONerror NONE, STEP NONE | with query | 6.110 |

| Command | Parameters | Remarks | Page |
|---|--|------------|-------|
| CONFigure:AFANalyzer:SECondary:EREPorting | SRQ SOPC SRSQ OFF | with query | 6.108 |
| CONFigure:AFANalyzer:SECondary:FILTer:BPASs:ACCoupling | BP01 to BP19 | with query | 6.112 |
| CONFigure:AFANalyzer:SECondary:FILTer:BPASs:DCCoupling | BP01 to BP19 | with query | 6.113 |
| CONFigure:AFANalyzer:SECondary:FILTer:VBPass:BWIDth | 10 Hz to 1000 Hz | with query | 6.111 |
| CONFigure:AFANalyzer:SECondary:FILTer:VBPass:CFRequency | 20 Hz to 21000 Hz | with query | 6.111 |
| CONFigure:AFANalyzer:SECondary:FILTer:WEIGHting | A CME CCI OFF | with query | 6.111 |
| CONFigure:AFANalyzer:SECondary:MTReduce | LOWF EXPF, <Frequency> | with query | 6.109 |
| FETCh:AFANalyzer:SECondary:STATus? | OFF RUN STOP ERR STEP RDY, 1 to 10000 NONE | query only | 6.109 |
| READ[:SCALar]:AFANalyzer:SECondary? | <Result> | query only | 6.114 |
| FETCh[:SCALar]:AFANalyzer:SECondary? | <Result> | query only | 6.114 |
| INITiate:AFANalyzer[:PRIMary] | – | no query | 6.108 |
| ABORt:AFANalyzer[:PRIMary] | – | no query | 6.108 |
| CONTinue:AFANalyzer[:PRIMary] | – | no query | 6.108 |
| CONFigure:AFANalyzer[:PRIMary]:CONTrol:COUPling | AC DC | with query | 6.110 |
| CONFigure:AFANalyzer[:PRIMary]:CONTrol:DISTortion[:FREQuency] | 100 Hz to 21000 Hz | with query | 6.110 |
| CONFigure:AFANalyzer[:PRIMary]:CONTrol:REPetition | CONTinuous SINGleshot 1 to 10000, SONerror NONE, STEP NONE | with query | 6.110 |
| CONFigure:AFANalyzer[:PRIMary]:EREPorting | SRQ SOPC SRSQ OFF | with query | 6.108 |
| CONFigure:AFANalyzer[:PRIMary]:FILTer:BPASs:ACCoupling | BP01 to BP19 | with query | 6.112 |
| CONFigure:AFANalyzer[:PRIMary]:FILTer:BPASs:DCCoupling | BP01 to BP19 | with query | 6.113 |
| CONFigure:AFANalyzer[:PRIMary]:FILTer:VBPass:BWIDth | 10 Hz to 1000 Hz | with query | 6.111 |
| CONFigure:AFANalyzer[:PRIMary]:FILTer:VBPass:CFRequency | 20 Hz to 21000 Hz | with query | 6.111 |
| CONFigure:AFANalyzer[:PRIMary]:FILTer:WEIGHting | A CME CCI OFF | with query | 6.111 |
| CONFigure:AFANalyzer[:PRIMary]:MTReduce | LOWF EXPF, <Frequency> | query only | 6.109 |
| FETCh:AFANalyzer[:PRIMary]:STATus? | OFF RUN STOP ERR STEP RDY, 1 to 10000 NONE | query only | 6.109 |
| READ[:SCALar]:AFANalyzer[:PRIMary]? | <Result> | query only | 6.114 |
| FETCh[:SCALar]:AFANalyzer[:PRIMary]? | <Result> | query only | 6.114 |
| Subsystem AFGenerator | | | |
| INITiate:AFGenerator:SECondary | – | no query | 6.114 |
| ABORt:AFGenerator:SECondary | – | no query | 6.114 |
| SOURce:AFGenerator:SECondary:FREQuency | 20 Hz to 21 kHz | with query | 6.115 |
| SOURce:AFGenerator:SECondary:LEVel | 0 μ V to 5 V | with query | 6.115 |
| SOURce:AFGenerator:SECondary:SMODE | AC DC | with query | 6.115 |
| FETCh:AFGenerator:SECondary:STATus? | OFF RUN ERR | query only | 6.115 |
| INITiate:AFGenerator[:PRIMary] | – | no query | 6.114 |
| ABORt:AFGenerator[:PRIMary] | – | no query | 6.114 |
| SOURce:AFGenerator[:PRIMary]:FREQuency | 20 Hz to 21 kHz | with query | 6.115 |
| SOURce:AFGenerator[:PRIMary]:LEVel | 0 μ V to 5 V | with query | 6.115 |
| SOURce:AFGenerator[:PRIMary]:SMODE | AC DC | with query | 6.115 |
| FETCh:AFGenerator[:PRIMary]:STATus? | OFF RUN ERR | query only | 6.115 |

| Command | Parameters | Remarks | Page |
|--|---|------------|-------|
| Subsystem AFLevel (AF input level) | | | |
| [SENSe:]AFLevel:DEFault | ON OFF | with query | 6.108 |
| [SENSe:]AFLevel:SECondary:MAXimum | <Level> | with query | 6.107 |
| [SENSe:]AFLevel:SECondary:MODE | MANual AUTO | with query | 6.107 |
| [SENSe:]AFLevel[:PRIMary]:MAXimum | <Level> | with query | 6.107 |
| [SENSe:]AFLevel[:PRIMary]:MODE | MANual AUTO | with query | 6.107 |
| Save/Recall of settings | | | |
| MMEMory:RECall:CURRent | <FileName> [,<msus>] | no query | 6.38 |
| MMEMory:SAVE:CURRent | <FileName> [,<msus>] | no query | 6.37 |
| Subsystem MULTitone | | | |
| INITiate:MULTitone:AF1Channel | – | no query | 6.116 |
| ABORt:MULTitone:AF1Channel | – | no query | 6.116 |
| STOP:MULTitone:AF1Channel | – | no query | 6.116 |
| CONTInue:MULTitone:AF1Channel | – | no query | 6.116 |
| CONFIgure:SUBarrays:MULTitone:AF1Channel | ALL ARITHmetical MINimum MAXimum IVAL,<Range>{,<Range>} | with query | 6.119 |
| CONFIgure:MULTitone:AF1Channel:AFGLead | 0 s to 0.1 s | with query | 6.118 |
| CONFIgure:MULTitone:AF1Channel:CONTRol:REPetition | CONTInuous SINGleshot 1 to 1000, SONerror NONE, STEP NONE | with query | 6.118 |
| CONFIgure:MULTitone:AF1Channel:COUPling | AC DC | with query | 6.117 |
| CONFIgure:MULTitone:AF1Channel:EREPorting | SRQ SOPC SRSQ OFF | with query | 6.117 |
| DEFault:MULTitone:AF1Channel:FILTer | ON OFF | with query | 6.125 |
| CONFIgure:MULTitone:AF1Channel:FILTer:BPASs:ACCoupling | BP01 to BP19 | with query | 6.125 |
| CONFIgure:MULTitone:AF1Channel:FILTer:BPASs:DCCoupling | BP01 to BP19 | with query | 6.124 |
| CONFIgure:MULTitone:AF1Channel:FILTer:WEIGHting | <Weighting> | with query | 6.125 |
| DISPlay:MULTitone:AF1Channel:GRID | ON OFF | with query | 6.117 |
| DEFault:MULTitone:AF1Channel:LIMit:LINE | ON OFF | with query | 6.121 |
| CONFIgure:MULTitone:AF1Channel:LIMit:LINE:ASYMmetric:LOWer | <Limit_1>, <Enable_1>, ... <Limit_20>, <Enable_20> | with query | 6.121 |
| CONFIgure:MULTitone:AF1Channel:LIMit:LINE:ASYMmetric:UPPer | <Limit_1>, <Enable_1>, ... <Limit_20>, <Enable_20> | with query | 6.120 |
| CALCulate[:SCALar]:MULTitone:AF1Channel:MATChing:LIMit? | <Result> | query only | 6.127 |
| CALCulate:ARRay:MULTitone:AF1Channel:MATChing:LIMit? | <Result> | query only | 6.127 |
| CONFIgure:MULTitone:AF1Channel:RLEVEL | 0.001 V to 5.000 V | with query | 6.117 |
| CONFIgure:MULTitone:AF1Channel:RMODE | RLEV TON1 ... TON20 | with query | 6.118 |
| FETCH:MULTitone:AF1Channel:STATus? | OFF RUN STOP ERR STEP RDY, 1 to 10000 NONE | query only | 6.117 |
| CONFIgure:MULTitone:AF1Channel:TDEFinition | <Freq_1>, <Lev_1>, <Enable_1>, ... <Freq_20>, <Lev_20>, <Enable_20> | with query | 6.122 |
| DEFault:MULTitone:AF1Channel:TDEFinition | ON OFF | with query | 6.124 |
| CONFIgure:MULTitone:AF1Channel:TDEFinition:MODE | <Total_Level> | with query | 6.123 |
| CONFIgure:MULTitone:AF1Channel:TDEFinition:TLEVEL | <Total_Level> | with query | 6.123 |
| CONFIgure:MULTitone:AF1Channel:TDEFinition:TONE<nr> | <Frequency>, <Level>, ON | with query | 6.123 |

| Command | Parameters | Remarks | Page |
|---|--|------------|-------|
| | OFF | | |
| CONFigure:MULTitone:AF1Channel:TONE<nr>:LIMit:LINE:ASYMmetric:LOWer | <Limit>, <Enable> | with query | 6.121 |
| CONFigure:MULTitone:AF1Channel:TONE<nr>:LIMit:LINE:ASYMmetric:UPPer | <Limit>, <Enable> | with query | 6.120 |
| CALCulate[:SCALar]:MULTitone:AF1Channel:TONE<nr>:MATChing:LIMit? | <Result> | query only | 6.127 |
| READ[:SCALar]:MULTitone:AF1Channel:TONE<nr>? | -100.0 dB to +20.0 dB | query only | 6.126 |
| FETCh[:SCALar]:MULTitone:AF1Channel:TONE<nr>? | -100.0 dB to +20.0 dB | query only | 6.126 |
| READ:ARRay:MULTitone:AF1Channel? | -100.0 dB to +20.0 dB | query only | 6.126 |
| FETCh:ARRay:MULTitone:AF1Channel? | -100.0 dB to +20.0 dB | query only | 6.126 |
| READ:SUBarrays:MULTitone:AF1Channel? | -100.0 dB to +20.0 dB | query only | 6.127 |
| FETCh:SUBarrays:MULTitone:AF1Channel? | -100.0 dB to +20.0 dB | query only | 6.127 |
| INITiate:MULTitone:AF2Channel | - | no query | 6.116 |
| ABORT:MULTitone:AF2Channel | - | no query | 6.116 |
| STOP:MULTitone:AF2Channel | - | no query | 6.116 |
| CONTinue:MULTitone:AF2Channel | - | no query | 6.116 |
| CONFigure:SUBarrays:MULTitone:AF2Channel | ALL ARITHmetical MINimum MAXimum IVAL XMINimum XMAXimum PAVG, <Range>{, <Range>} | with query | 6.119 |
| CONFigure:MULTitone:AF2Channel:AFGLead | 0 s to 0.1 s | with query | 6.118 |
| CONFigure:MULTitone:AF2Channel:CONTRol:REPetition | CONTinuous SINGleshot 1 to 1000, SONerror NONE, STEP NONE | with query | 6.118 |
| CONFigure:MULTitone:AF2Channel:COUPling | AC DC | with query | 6.117 |
| CONFigure:MULTitone:AF2Channel:EREPorting | SRQ SOPC SRSQ OFF | with query | 6.117 |
| DEFault:MULTitone:AF2Channel:FILTer | ON OFF | with query | 6.125 |
| CONFigure:MULTitone:AF2Channel:FILTer:BPASs:ACCoupling | BP01 to BP19 | with query | 6.125 |
| CONFigure:MULTitone:AF2Channel:FILTer:BPASs:ACCoupling | BP01 to BP19 | with query | 6.136 |
| CONFigure:MULTitone:AF2Channel:FILTer:BPASs:DCCoupling | BP01 to BP19 | with query | 6.124 |
| CONFigure:MULTitone:AF2Channel:FILTer:WEIGhting | <Weighting> | with query | 6.125 |
| DISPlay:MULTitone:AF2Channel:GRID | ON OFF | with query | 6.117 |
| DEFault:MULTitone:AF2Channel:LIMit:LINE | ON OFF | with query | 6.121 |
| CONFigure:MULTitone:AF2Channel:LIMit:LINE:ASYMmetric:LOWer | <Limit_1>, <Enable_1>, ... <Limit_20>, <Enable_20> | with query | 6.121 |
| CONFigure:MULTitone:AF2Channel:LIMit:LINE:ASYMmetric:UPPer | <Limit_1>, <Enable_1>, ... <Limit_20>, <Enable_20> | with query | 6.120 |
| CALCulate[:SCALar]:MULTitone:AF2Channel:MATChing:LIMit? | <Result> | query only | 6.127 |
| CALCulate:ARRay:MULTitone:AF2Channel:MATChing:LIMit? | <Result> | query only | 6.127 |
| CONFigure:MULTitone:AF2Channel:RLEVEL | 0.001 V to 5.000 V | with query | 6.117 |
| CONFigure:MULTitone:AF2Channel:RMODE | RLEV TON1 ... TON20 | with query | 6.118 |
| FETCh:MULTitone:AF2Channel:STATus? | OFF RUN STOP ERR STEP RDY, 1 to 10000 NONE | query only | 6.117 |
| CONFigure:MULTitone:AF2Channel:TDEFinition | <Freq_1>, <Lev_1>, <Enable_1>, ... <Freq_20>, <Lev_20>, <Enable_20> | with query | 6.122 |
| DEFault:MULTitone:AF2Channel:TDEFinition | ON OFF | with query | 6.124 |
| CONFigure:MULTitone:AF2Channel:TDEFinition:MODE | <Total_Level> | with query | 6.123 |

| Command | Parameters | Remarks | Page |
|---|---|------------|-------|
| CONFigure:MULTitone:AF2Channel:TDEFinition:TLEVel | <Total_Level> | with query | 6.123 |
| CONFigure:MULTitone:AF2Channel:TDEFinition:TONE<nr> | <Frequency>, <Level>, ON OFF | with query | 6.123 |
| CONFigure:MULTitone:AF2Channel:TONE<nr>:LIMit:LINE:ASYMmetric:LOWer | <Limit>, <Enable> | with query | 6.121 |
| CONFigure:MULTitone:AF2Channel:TONE<nr>:LIMit:LINE:ASYMmetric:UPPer | <Limit>, <Enable> | with query | 6.120 |
| CALCulate[:SCALar]:MULTitone:AF2Channel:TONE<nr>:MATChing:LIMit? | <Result> | query only | 6.127 |
| READ[:SCALar]:MULTitone:AF2Channel:TONE<nr>? | -100.0 dB to +20.0 dB | query only | 6.126 |
| FETCh[:SCALar]:MULTitone:AF2Channel:TONE<nr>? | -100.0 dB to +20.0 dB | query only | 6.126 |
| READ:ARRay:MULTitone:AF2Channel? | -100.0 dB to +20.0 dB | query only | 6.126 |
| FETCh:ARRay:MULTitone:AF2Channel? | -100.0 dB to +20.0 dB | query only | 6.126 |
| READ:SUBarrays:MULTitone:AF2Channel? | -100.0 dB to +20.0 dB | query only | 6.127 |
| FETCh:SUBarrays:MULTitone:AF2Channel? | -100.0 dB to +20.0 dB | query only | 6.127 |
| DEFault:MULTitone:FILTer | ON OFF | with query | 6.126 |
| DEFault:MULTitone:LIMit:LINE | ON OFF | with query | 6.122 |
| INITiate:MULTitone:STEReo | - | no query | 6.128 |
| ABORt:MULTitone:STEReo | - | no query | 6.128 |
| STOP:MULTitone:STEReo | - | no query | 6.128 |
| CONTInue:MULTitone:STEReo | - | no query | 6.128 |
| CALCulate[:SCALar]:MULTitone:STEReo:AF1Channel:MATChing:LIMit? | <Result> | query only | 6.138 |
| CALCulate:ARRay:MULTitone:STEReo:AF1Channel:MATChing:LIMit? | <Result> | query only | 6.139 |
| CALCulate[:SCALar]:MULTitone:STEReo:AF1Channel:TONE<nr>:MATChing:LIMit? | <Result> | query only | 6.138 |
| READ[:SCALar]:MULTitone:STEReo:AF1Channel:TONE<nr>? | -100.0 dB to +20.0 dB | query only | 6.137 |
| FETCh[:SCALar]:MULTitone:STEReo:AF1Channel:TONE<nr>? | -100.0 dB to +20.0 dB | query only | 6.137 |
| READ:ARRay:MULTitone:STEReo:AF1Channel? | -100.0 dB to +20.0 dB | query only | 6.137 |
| FETCh:ARRay:MULTitone:STEReo:AF1Channel? | -100.0 dB to +20.0 dB | query only | 6.137 |
| CALCulate[:SCALar]:MULTitone:STEReo:AF2Channel:MATChing:LIMit? | <Result> | query only | 6.138 |
| CALCulate:ARRay:MULTitone:STEReo:AF2Channel:MATChing:LIMit? | <Result> | query only | 6.139 |
| CALCulate[:SCALar]:MULTitone:STEReo:AF2Channel:TONE<nr>:MATChing:LIMit? | <Result> | query only | 6.138 |
| READ[:SCALar]:MULTitone:STEReo:AF2Channel:TONE<nr>? | -100.0 dB to +20.0 dB | query only | 6.137 |
| FETCh[:SCALar]:MULTitone:STEReo:AF2Channel:TONE<nr>? | -100.0 dB to +20.0 dB | query only | 6.137 |
| READ:ARRay:MULTitone:STEReo:AF2Channel? | -100.0 dB to +20.0 dB | query only | 6.137 |
| FETCh:ARRay:MULTitone:STEReo:AF2Channel? | -100.0 dB to +20.0 dB | query only | 6.137 |
| CONFigure:MULTitone:STEReo:AFGLead | 0 s to 0.1 s, 0 s to 0.1 s | with query | 6.130 |
| CONFigure:MULTitone:STEReo:CONTROL:REPetition | CONTInuous SINGleshot 1 to 1000, SONerror NONE, STEP NONE | with query | 6.129 |
| CONFigure:MULTitone:STEReo:COUPLing | AC DC, AC DC | with query | 6.129 |
| CONFigure:MULTitone:STEReo:EREPorting | SRQ SOPC SRSQ OFF | with query | 6.128 |
| DEFault:MULTitone:STEReo:FILTer | ON OFF | with query | 6.136 |
| CONFigure:MULTitone:STEReo:FILTer:BPASs:ACCoupling | BP01 to BP19, BP01 to BP19 | with query | 6.136 |

| Command | Parameters | Remarks | Page |
|--|---|------------|-------|
| CONFigure:MULTitone:STEReo:FILTER:BPASs:DCCoupling | BP01 to BP19, BP01 to BP19 | with query | 6.135 |
| CONFigure:MULTitone:STEReo:FILTER:WEIGHting | <Weighting_1>, <Weighting_2> | with query | 6.136 |
| DEFault:MULTitone:STEReo:LIMit:LINE | ON OFF | with query | 6.132 |
| CONFigure:MULTitone:STEReo:LIMit:LINE:ASYMmetric:LOWer | <Limit_1_1>, <Enable_1_1>, ... <Limit_20_2>, <Enable_20_2> | with query | 6.132 |
| CONFigure:MULTitone:STEReo:LIMit:LINE:ASYMmetric:UPPer | <Limit_1_1>, <Enable_1_1>, ... <Limit_20_2>, <Enable_20_2> | with query | 6.131 |
| CALCulate[:SCALar]:MULTitone:STEReo:MATCHing:LIMit? | <Result> | query only | 6.139 |
| CALCulate:ARRay:MULTitone:STEReo:MATCHing:LIMit? | <Result> | query only | 6.139 |
| CONFigure:MULTitone:STEReo:RLEVel | 0.001 V to 5.000 V | with query | 6.129 |
| CONFigure:MULTitone:STEReo:RMODE | RLEV TON1 ... TON20 | with query | 6.130 |
| FETCh:MULTitone:STEReo:STATus? | OFF RUN STOP ERR STEP RDY, 1 to 10000 NONE | query only | 6.128 |
| CONFigure:MULTitone:STEReo:TDEFinition | <Freq_1_1>, <Lev_1_1>, <Enable_1_1>, ... <Freq_20_2>, <Lev_20_2>, <Enable_20_2> | with query | 6.133 |
| DEFault:MULTitone:STEReo:TDEFinition | ON OFF | with query | 6.135 |
| CONFigure:MULTitone:STEReo:TDEFinition:MODE | <Mode_1>, <Mode_2> | with query | 6.134 |
| CONFigure:MULTitone:STEReo:TDEFinition:TLEVel | <Total_Level_1>, <Total_Level_2> | with query | 6.134 |
| CONFigure:MULTitone:STEReo:TDEFinition:TONE<nr> | <Frequency>, <Level>, ON OFF, <Frequency>, <Level>, ON OFF | with query | 6.134 |
| CONFigure:MULTitone:STEReo:TONE<nr>:LIMit:LINE:ASYMmetric:LOWer | <Limit_1>, <Enable_1>, <Limit_2>, <Enable_2> | with query | 6.132 |
| CONFigure:MULTitone:STEReo:TONE<nr>:LIMit:LINE:ASYMmetric:UPPer | <Limit_1>, <Enable_1>, <Limit_2>, <Enable_2> | with query | 6.131 |
| CALCulate[:SCALar]:MULTitone:STEReo:TONE<nr>:MATCHing:LIMit? | <Result> | query only | 6.138 |
| READ[:SCALar]:MULTitone:STEReo:TONE<nr>? | -100.0 dB to +20.0 dB | query only | 6.137 |
| FETCh[:SCALar]:MULTitone:STEReo:TONE<nr>? | -100.0 dB to +20.0 dB | query only | 6.137 |
| READ:ARRay:MULTitone:STEReo? | -100.0 dB to +20.0 dB | query only | 6.138 |
| FETCh:ARRay:MULTitone:STEReo? | -100.0 dB to +20.0 dB | query only | 6.138 |
| DEFault:MULTitone:TDEFinition | ON OFF | with query | 6.124 |
| System STATus:OPERation (symbolic status register evaluation) | | | |
| STATus:OPERation:SYMBolic:ENABLE | <Event>{,<Event>} | with query | 6.38 |
| STATus:OPERation:SYMBolic[:EVENT]? | NONE <Event>{,<Event>} | query only | 6.39 |
| Subsystem OPTions (option info) | | | |
| SYSTem:OPTions:INFO:CURRent? | | query only | 6.37 |
| Subsystem RESet (partial reset) | | | |
| SYSTem:RESet:CURRent | | no query | 6.38 |
| Subsystem THD | | | |
| INITiate:THD:AF1Channel | - | no query | 6.140 |

| Command | Parameters | Remarks | Page |
|--|---|------------|-------|
| ABORT:THD:AF1Channel | – | no query | 6.140 |
| STOP:THD:AF1Channel | – | no query | 6.140 |
| CONTINUE:THD:AF1Channel | – | no query | 6.140 |
| CONFIGure:THD:AF1Channel:CONTRol:REPetition | CONTInuous SINGleshot 1 to 1000, SONerror NONE, STEP NONE | with query | 6.141 |
| CONFIGure:THD:AF1Channel:COUPling | AC DC | with query | 6.142 |
| CONFIGure:THD:AF1Channel:EREPorting | SRQ SOPC SRSQ OFF | with query | 6.140 |
| DEFault:THD:AF1Channel:FILTer | ON OFF | with query | 6.144 |
| CONFIGure:THD:AF1Channel:FILTer:BPASs:ACCoupling | BP01 to BP19 | with query | 6.143 |
| CONFIGure:THD:AF1Channel:FILTer:BPASs:DCCoupling | BP01 to BP19 | with query | 6.143 |
| CONFIGure:THD:AF1Channel:FILTer:WEIGHting | <Weighting> | with query | 6.144 |
| READ[:SCALar]:THD:AF1Channel:HARMonic<nr>? | –150.0 dB to +150.0 dB | query only | 6.144 |
| FETCH[:SCALar]:THD:AF1Channel:HARMonic<nr>? | –150.0 dB to +150.0 dB | query only | 6.144 |
| CONFIGure:THD:AF1Channel:HARMonics<nr> | <Enable> | with query | 6.142 |
| FETCH:THD:AF1Channel:STATus? | OFF RUN STOP ERR STEP RDY, 1 to 10000 NONE | query only | 6.141 |
| CONFIGure:THD:AF1Channel:TDEFinition | <Frequency>, <Level> | with query | 6.142 |
| READ[:SCALar]:THD:AF1Channel:THD? | 0 % to 100 %, –150.0 dB to 0.0 dB | query only | 6.145 |
| FETCH[:SCALar]:THD:AF1Channel:THD? | 0 % to 100 %, –150.0 dB to 0.0 dB | query only | 6.145 |
| READ:ARRay:THD:AF1Channel? | –150.0 dB to +150.0 dB | query only | 6.145 |
| FETCH:ARRay:THD:AF1Channel? | –150.0 dB to +150.0 dB | query only | 6.145 |
| INITiate:THD:AF2Channel | – | no query | 6.140 |
| ABORT:THD:AF2Channel | – | no query | 6.140 |
| STOP:THD:AF2Channel | – | no query | 6.140 |
| CONTINUE:THD:AF2Channel | – | no query | 6.140 |
| CONFIGure:THD:AF2Channel:CONTRol:REPetition | CONTInuous SINGleshot 1 to 1000, SONerror NONE, STEP NONE | with query | 6.141 |
| CONFIGure:THD:AF2Channel:COUPling | AC DC | with query | 6.142 |
| CONFIGure:THD:AF2Channel:EREPorting | SRQ SOPC SRSQ OFF | with query | 6.140 |
| DEFault:THD:AF2Channel:FILTer | ON OFF | with query | 6.144 |
| CONFIGure:THD:AF2Channel:FILTer:BPASs:ACCoupling | BP01 to BP19 | with query | 6.143 |
| CONFIGure:THD:AF2Channel:FILTer:BPASs:DCCoupling | BP01 to BP19 | with query | 6.143 |
| CONFIGure:THD:AF2Channel:FILTer:WEIGHting | <Weighting> | with query | 6.144 |
| READ[:SCALar]:THD:AF2Channel:HARMonic<nr>? | –150.0 dB to +150.0 dB | query only | 6.144 |
| FETCH[:SCALar]:THD:AF2Channel:HARMonic<nr>? | –150.0 dB to +150.0 dB | query only | 6.144 |
| CONFIGure:THD:AF2Channel:HARMonics<nr> | <Enable> | with query | 6.142 |
| FETCH:THD:AF2Channel:STATus? | OFF RUN STOP ERR STEP RDY, 1 to 10000 NONE | query only | 6.141 |
| CONFIGure:THD:AF2Channel:TDEFinition | <Frequency>, <Level> | with query | 6.142 |
| READ[:SCALar]:THD:AF2Channel:THD? | 0 % to 100 %, –150.0 dB to 0.0 dB | query only | 6.145 |
| FETCH[:SCALar]:THD:AF2Channel:THD? | 0 % to 100 %, –150.0 dB to 0.0 dB | query only | 6.145 |

| Command | Parameters | Remarks | Page |
|--|--|------------|-------|
| READ:ARRay:THD:AF2Channel? | -150.0 dB to +150.0 dB | query only | 6.145 |
| FETCh:ARRay:THD:AF2Channel? | -150.0 dB to +150.0 dB | query only | 6.145 |
| DEFault:THD:FILTer | ON OFF | with query | 6.144 |
| INITiate:THD:STEReo | - | no query | 6.145 |
| ABORt:THD:STEReo | - | no query | 6.145 |
| STOP:THD:STEReo | - | no query | 6.145 |
| CONTinue:THD:STEReo | - | no query | 6.145 |
| READ[:SCALar]:THD:STEReo:AF1Channel:HARMonic<nr>? | -150.0 dB to +150.0 dB | query only | 6.148 |
| FETCh[:SCALar]:THD:STEReo:AF1Channel:HARMonic<nr>? | -150.0 dB to +150.0 dB | query only | 6.148 |
| READ[:SCALar]:THD:STEReo:AF1Channel:THD? | 0 % to 100 %, -150.0 dB to 0.0 dB | query only | 6.149 |
| FETCh[:SCALar]:THD:STEReo:AF1Channel:THD? | 0 % to 100 %, -150.0 dB to 0.0 dB | query only | 6.149 |
| READ:ARRay:THD:STEReo:AF1Channel? | -150.0 dB to +150.0 dB | query only | 6.148 |
| FETCh:ARRay:THD:STEReo:AF1Channel? | -150.0 dB to +150.0 dB | query only | 6.148 |
| READ[:SCALar]:THD:STEReo:AF2Channel:HARMonic<nr>? | -150.0 dB to +150.0 dB | query only | 6.148 |
| FETCh[:SCALar]:THD:STEReo:AF2Channel:HARMonic<nr>? | -150.0 dB to +150.0 dB | query only | 6.148 |
| READ[:SCALar]:THD:STEReo:AF2Channel:THD? | 0 % to 100 %, -150.0 dB to 0.0 dB | query only | 6.149 |
| FETCh[:SCALar]:THD:STEReo:AF2Channel:THD? | 0 % to 100 %, -150.0 dB to 0.0 dB | query only | 6.149 |
| READ:ARRay:THD:STEReo:AF2Channel? | -150.0 dB to +150.0 dB | query only | 6.148 |
| FETCh:ARRay:THD:STEReo:AF2Channel? | -150.0 dB to +150.0 dB | query only | 6.148 |
| CONFigure:THD:STEReo:CONTRol:REPetition | CONTInuous SINGleshot 1 to 10000, SONerror NONE, STEP NONE | with query | 6.146 |
| CONFigure:THD:STEReo:EREPorting | SRQ SOPC SRSQ OFF | with query | 6.146 |
| READ[:SCALar]:THD:STEReo:HARMonic<nr>? | -150.0 dB to +150.0 dB | query only | 6.148 |
| FETCh[:SCALar]:THD:STEReo:HARMonic<nr>? | -150.0 dB to +150.0 dB | query only | 6.148 |
| CONFigure:THD:STEReo:HARMonics<nr> | <Enable_1>, <Enable_2> | with query | 6.147 |
| FETCh:THD:STEReo:STATus? | OFF RUN STOP ERR STEP RDY, 1 to 10000 NONE | query only | 6.146 |
| CONFigure:THD:STEReo:TDEFinition | <Frequency_1>, <Level_1>, <Frequency_2>, <Level_2> | with query | 6.147 |
| READ[:SCALar]:THD:STEReo:THD? | 0 % to 100 %, -150.0 dB to 0.0 dB | query only | 6.149 |
| FETCh[:SCALar]:THD:STEReo:THD? | 0 % to 100 %, -150.0 dB to 0.0 dB | query only | 6.149 |
| READ:ARRay:THD:STEReo? | -150.0 dB to +150.0 dB | query only | 6.148 |
| FETCh:ARRay:THD:STEReo? | -150.0 dB to +150.0 dB | query only | 6.148 |

Alphabetical Command Lists

Table 6-4 Alphabetical list of remote-control commands: Base system

| Command (Base System, alphabetical) | Page |
|--|------|
| *GTL | 6.25 |
| *LLO | 6.27 |
| *SEC | 6.14 |
| [SENSe:]IPADdress:FCODE? | 6.23 |
| [SENSe:]SYNChronize:FREQuency:REFerence:LOCKed? | 6.34 |
| CONFigure:SYNChronize:FREQuency:REFerence | 6.33 |
| CONFigure:SYNChronize:FREQuency:REFerence:MODE | 6.33 |
| CONFigure:USER:CORRection:LOSS:TABLE:ENABLE | 6.36 |
| CONFigure:USER:CORRection:LOSS:TABLE:LINE<nr>? | 6.37 |
| CONFigure:USER:CORRection:LOSS:TABLE? | 6.36 |
| DEFault:USER:CORRection:LOSS | 6.36 |
| DISPlay[:WINDow][::STATe]? | 6.36 |
| MMEMemory:CDIRectory | 6.30 |
| MMEMemory:COMMeNt | 6.29 |
| MMEMemory:COpy | 6.31 |
| MMEMemory:DATA? | 6.32 |
| MMEMemory:DELete | 6.30 |
| MMEMemory:DIRectory[:CURRent]? | 6.30 |
| MMEMemory:INFO? | 6.29 |
| MMEMemory:MKDir | 6.30 |
| MMEMemory:MOVE | 6.31 |
| MMEMemory:MSIS | 6.29 |
| MMEMemory:RECall:CURRent | 6.33 |
| MMEMemory:RECall[:ALL] | 6.33 |
| MMEMemory:REName | 6.31 |
| MMEMemory:RMDir | 6.30 |
| MMEMemory:SAVE:CURRent | 6.32 |
| MMEMemory:SAVE[:ALL] | 6.32 |
| MMEMemory:SAVE[:ALL] | 6.33 |
| MMEMemory:SCAN? | 6.31 |
| MMEMemory:SCAN? | 6.33 |
| SORT:USER:CORRection:LOSS:TABLE | 6.37 |
| STATus:OPERation:CMU:ALL | 6.11 |
| STATus:OPERation:CMU:CLEar | 6.11 |
| STATus:OPERation:CMU:SUM<nr>:CMU<nr_event>:ENABLE | 6.10 |
| STATus:OPERation:CMU:SUM<nr>:CMU<nr_event>[EVENT]? | 6.10 |
| STATus:OPERation:CMU:SUM<nr>:ENABLE | 6.10 |
| STATus:OPERation:CMU:SUM<nr>[EVENT]? | 6.10 |
| STATus:OPERation:ENABLE | 6.10 |
| STATus:OPERation:EVENT:SADdress? | 6.12 |
| STATus:OPERation:SYMBOLic:ENABLE | 6.12 |
| STATus:OPERation:SYMBOLic[EVENT]? | 6.12 |
| STATus:OPERation[EVENT]? | 6.9 |
| STATus:PRESet | 6.11 |
| STATus:QUEStionable:ENABLE | 6.11 |
| STATus:QUEStionable[EVENT]? | 6.11 |
| SYSTem:[TIME:]DATE | 6.19 |
| SYSTem:[TIME:]TIME | 6.18 |
| SYSTem:[TIME:]TZONe | 6.18 |
| SYSTem:COMMunicate:GPIB[:SELF]:ADDress | 6.16 |
| SYSTem:COMMunicate:SERial<1 2>:APPLication | 6.16 |
| SYSTem:COMMunicate:SERial<1 2>:TRANsmit:PACe | 6.17 |

| | |
|---|------|
| SYSTem:COMMunicate:SERial<1 2>[:RECeive]:BAUD..... | 6.16 |
| SYSTem:COMMunicate:SERial<1 2>[:RECeive]:BITS..... | 6.16 |
| SYSTem:COMMunicate:SERial<1 2>[:RECeive]:PARity[:TYPE]..... | 6.17 |
| SYSTem:COMMunicate:SERial<1 2>[:RECeive]:STOP..... | 6.17 |
| SYSTem:ERRor?..... | 6.8 |
| SYSTem:ERRor?..... | 6.8 |
| SYSTem:GTRMode:COMPAtible..... | 6.25 |
| SYSTem:MISC:KBEep..... | 6.19 |
| SYSTem:MISC:KEYBoard..... | 6.19 |
| SYSTem:MQUeue[:COMPlete]:ITEM?..... | 6.26 |
| SYSTem:MQUeue[:COMPlete][:LIST]?..... | 6.25 |
| SYSTem:NONVolatile:DISable..... | 6.8 |
| SYSTem:OPTions:INFO?..... | 6.17 |
| SYSTem:OPTions:MEquipment?..... | 6.9 |
| SYSTem:OPTions?..... | 6.18 |
| SYSTem:PRESet[:ALL]..... | 6.26 |
| SYSTem:REBoot..... | 6.8 |
| SYSTem:REBoot:ERRor?..... | 6.9 |
| SYSTem:REMOte:ADDRess:PRIMary..... | 6.13 |
| SYSTem:REMOte:ADDRess:SECOndary..... | 6.14 |
| SYSTem:REMOte:ADDRess:SECOndary:UNMap..... | 6.14 |
| SYSTem:REMOte:FORMat:NUMeric..... | 6.15 |
| SYSTem:REMOte:FORMat:NUMeric..... | 6.15 |
| SYSTem:REMOte:RDMode..... | 6.15 |
| SYSTem:REMOte:TPManagement..... | 6.15 |
| SYSTem:RESet:CURRent..... | 6.27 |
| SYSTem:RESet[:ALL]..... | 6.27 |
| SYSTem:TCPIp:PRIMary:DEFault..... | 6.20 |
| SYSTem:TCPIp:PRIMary:STATic:DGATeway..... | 6.21 |
| SYSTem:TCPIp:PRIMary:STATic:IPADdress..... | 6.20 |
| SYSTem:TCPIp:PRIMary:STATic:SMASK..... | 6.20 |
| SYSTem:TCPIp:SECOndary:DEFault..... | 6.21 |
| SYSTem:TCPIp:SECOndary:DYNamic:DGATeway?..... | 6.24 |
| SYSTem:TCPIp:SECOndary:DYNamic:DNS?..... | 6.23 |
| SYSTem:TCPIp:SECOndary:DYNamic:HNAME..... | 6.23 |
| SYSTem:TCPIp:SECOndary:DYNamic:IPADdress?..... | 6.24 |
| SYSTem:TCPIp:SECOndary:DYNamic:SMASK?..... | 6.24 |
| SYSTem:TCPIp:SECOndary:MODE..... | 6.21 |
| SYSTem:TCPIp:SECOndary:STATic:DGATeway..... | 6.22 |
| SYSTem:TCPIp:SECOndary:STATic:IPADdress..... | 6.22 |
| SYSTem:TCPIp:SECOndary:STATic:SMASK..... | 6.22 |
| SYSTem:VERSion?..... | 6.8 |
| TRACe:REMOte:MODE:DISPlay..... | 6.28 |
| TRACe:REMOte:MODE:ERRor..... | 6.29 |
| TRACe:REMOte:MODE:FILE..... | 6.28 |
| TRACe:REMOte:MODE:OUTLines..... | 6.29 |
| TRACe:REMOte:MODE:SRQ..... | 6.29 |
| TRACe:REMOte:MODE:OUTLines..... | 6.29 |
| TRACe:REMOte:MODE:SRQ..... | 6.29 |

Table 6-5 Alphabetical list of remote-control commands: RF

| Command (RF, alphabetical) | Page |
|--|-------|
| ABORt:IQRecorder..... | 6.82 |
| ABORt:IQSLot..... | 6.98 |
| ABORt:NPOWer..... | 6.78 |
| ABORt:POWer..... | 6.61 |
| ABORt:RFANalyzer..... | 6.43 |
| ABORt:RFGenerator..... | 6.46 |
| ABORt:RFGenerator..... | 6.51 |
| ABORt:RFGenerator:GLIStmode:DEFault..... | 6.53 |
| ABORt:SPEctrum..... | 6.68 |
| ABORt:WPOWer..... | 6.76 |
| CONFigure:IQIF:RXPath..... | 6.59 |
| CONFigure:IQIF:RXTXcombined..... | 6.59 |
| CONFigure:IQIF:TXPath..... | 6.59 |
| CONFigure:IQRecorder:CONTRol:CLEngth..... | 6.84 |
| CONFigure:IQRecorder:CONTRol:CTIMEout..... | 6.84 |
| CONFigure:IQRecorder:CONTRol:FILTer..... | 6.83 |
| CONFigure:IQRecorder:CONTRol:GFILTer..... | 6.84 |
| CONFigure:IQRecorder:CONTRol:LFOFormat..... | 6.85 |
| CONFigure:IQRecorder:CONTRol:NFILTer..... | 6.84 |
| CONFigure:IQRecorder:CONTRol:RMODe..... | 6.85 |
| CONFigure:IQRecorder:CONTRol:TDELAy..... | 6.84 |
| CONFigure:IQRecorder:EREPorting..... | 6.82 |
| CONFigure:IQSLot:CONTRol:CTIMEout..... | 6.101 |
| CONFigure:IQSLot:CONTRol:FELimit..... | 6.101 |
| CONFigure:IQSLot:CONTRol:MLEngth..... | 6.101 |
| CONFigure:IQSLot:CONTRol:NOSTeps..... | 6.100 |
| CONFigure:IQSLot:CONTRol:NOSubsweeps..... | 6.100 |
| CONFigure:IQSLot:CONTRol:REPetition..... | 6.100 |
| CONFigure:IQSLot:CONTRol:SELection..... | 6.102 |
| CONFigure:IQSLot:CONTRol:SLEngth..... | 6.101 |
| CONFigure:IQSLot:CONTRol:TOFFset..... | 6.101 |
| CONFigure:IQSLot:EREPorting..... | 6.98 |
| CONFigure:NPOWer:CONTRol..... | 6.79 |
| CONFigure:NPOWer:CONTRol:REPetition..... | 6.80 |
| CONFigure:NPOWer:CONTRol:STATistics..... | 6.80 |
| CONFigure:NPOWer:EREPorting..... | 6.78 |
| CONFigure:POWer:CONTRol..... | 6.62 |
| CONFigure:POWer:CONTRol:REPetition..... | 6.62 |
| CONFigure:POWer:CONTRol:TIMEout..... | 6.64 |
| CONFigure:POWer:EREPorting..... | 6.61 |
| CONFigure:RFANalyzer:CONTRol:REPetition..... | 6.44 |
| CONFigure:RFANalyzer:EREPorting..... | 6.43 |
| CONFigure:RFANalyzer:POWer:RTIME..... | 6.44 |
| CONFigure:SPEctrum:CONTRol..... | 6.69 |
| CONFigure:SPEctrum:CONTRol:REPetition..... | 6.70 |
| CONFigure:SPEctrum:EREPorting..... | 6.68 |
| CONFigure:SUBarrays:IQRecorder..... | 6.86 |
| CONFigure:SUBarrays:IQSLot..... | 6.103 |
| CONFigure:SUBarrays:POWer..... | 6.65 |
| CONFigure:SUBarrays:SPEctrum..... | 6.72 |
| CONFigure:WPOWer:CONTRol:REPetition..... | 6.77 |
| CONFigure:WPOWer:EREPorting..... | 6.76 |
| CONTinue:IQSLot..... | 6.98 |
| CONTinue:NPOWer..... | 6.78 |
| CONTinue:POWer..... | 6.61 |
| CONTinue:RFANalyzer..... | 6.43 |
| CONTinue:SPEctrum..... | 6.68 |
| CONTinue:WPOWer..... | 6.76 |
| DEFault:IQRecorder:CONTRol..... | 6.85 |
| DEFault:IQSLot:CONTRol..... | 6.100 |

| Command (RF, alphabetical) | Page |
|--------------------------------------|-------|
| DEFault:RFGenerator | 6.45 |
| DEFault:RFGenerator:AUXTx | 6.51 |
| DEFault:RFGenerator:GLISmode | 6.53 |
| DEFault:RFGenerator:TX | 6.45 |
| DISPlay:POWer:CONTRol:GRID | 6.62 |
| DISPlay:SPECTrum:CONTRol:GRID | 6.70 |
| FETCh:ARRay:IQRecorder:I? | 6.88 |
| FETCh:ARRay:IQRecorder:IQ? | 6.89 |
| FETCh:ARRay:IQRecorder:LEVel? | 6.87 |
| FETCh:ARRay:IQRecorder:PHASe? | 6.87 |
| FETCh:ARRay:IQRecorder:PL? | 6.88 |
| FETCh:ARRay:IQRecorder:Q? | 6.89 |
| FETCh:ARRay:IQSLot:I? | 6.104 |
| FETCh:ARRay:IQSLot:LEVel? | 6.104 |
| FETCh:ARRay:IQSLot:PHASe? | 6.104 |
| FETCh:ARRay:IQSLot:Q? | 6.104 |
| FETCh:ARRay:POWer:AVERage? | 6.66 |
| FETCh:ARRay:POWer:MAXimum? | 6.66 |
| FETCh:ARRay:POWer:MINimum? | 6.66 |
| FETCh:ARRay:POWer:MINimum? | 6.66 |
| FETCh:ARRay:POWer[:CURRent]? | 6.66 |
| FETCh:ARRay:SPECTrum:AVERage? | 6.74 |
| FETCh:ARRay:SPECTrum:MAXimum? | 6.74 |
| FETCh:ARRay:SPECTrum:MINimum? | 6.74 |
| FETCh:ARRay:SPECTrum:MINimum? | 6.74 |
| FETCh:ARRay:SPECTrum[:CURRent]? | 6.74 |
| FETCh:BINary:ARRay:IQRecorder:I? | 6.96 |
| FETCh:BINary:ARRay:IQRecorder:IQ? | 6.97 |
| FETCh:BINary:ARRay:IQRecorder:LEVel? | 6.94 |
| FETCh:BINary:ARRay:IQRecorder:PHASe? | 6.93 |
| FETCh:BINary:ARRay:IQRecorder:PL? | 6.95 |
| FETCh:BINary:ARRay:IQRecorder:Q? | 6.96 |
| FETCh:IQRecorder:FSBW? | 6.83 |
| FETCh:IQRecorder:STATus? | 6.82 |
| FETCh:IQSLot:STATus? | 6.98 |
| FETCh:NPOWer:STATus? | 6.79 |
| FETCh:POWer:STATus? | 6.61 |
| FETCh:RFANalyzer:STATus? | 6.44 |
| FETCh:RFGenerator:AUXTx:STATus? | 6.51 |
| FETCh:RFGenerator[:TX]:STATus? | 6.46 |
| FETCh:SPECTrum:MARKer:ABSolute? | 6.73 |
| FETCh:SPECTrum:MARKer:PEAK? | 6.73 |
| FETCh:SPECTrum:MARKer:RELative? | 6.73 |
| FETCh:SPECTrum:STATus? | 6.69 |
| FETCh:SUBarrays:IQRecorder:I? | 6.91 |
| FETCh:SUBarrays:IQRecorder:IQ? | 6.92 |
| FETCh:SUBarrays:IQRecorder:LEVel? | 6.90 |
| FETCh:SUBarrays:IQRecorder:PHASe? | 6.90 |
| FETCh:SUBarrays:IQRecorder:PL? | 6.91 |
| FETCh:SUBarrays:IQRecorder:Q? | 6.92 |
| FETCh:SUBarrays:IQSLot:I? | 6.105 |
| FETCh:SUBarrays:IQSLot:LEVel? | 6.105 |
| FETCh:SUBarrays:IQSLot:PHASe? | 6.105 |
| FETCh:SUBarrays:IQSLot:Q? | 6.105 |
| FETCh:SUBarrays:POWer:AVERage? | 6.67 |
| FETCh:SUBarrays:POWer:MAXimum? | 6.67 |
| FETCh:SUBarrays:POWer:MINimum? | 6.67 |
| FETCh:SUBarrays:POWer:MINimum? | 6.67 |
| FETCh:SUBarrays:POWer[:CURRent]? | 6.67 |
| FETCh:SUBarrays:SPECTrum:AVERage? | 6.75 |
| FETCh:SUBarrays:SPECTrum:MAXimum? | 6.75 |
| FETCh:SUBarrays:SPECTrum:MINimum? | 6.75 |
| FETCh:SUBarrays:SPECTrum:MINimum? | 6.75 |

| Command (RF, alphabetical) | Page |
|--|-------|
| FETCh:SUBarrays:SPECTrum[:CURRent]? | 6.75 |
| FETCh:WPOWer:STATus? | 6.76 |
| FETCh[:SCALar]:IQSLot[:FREQuency:OFFSet]? | 6.103 |
| FETCh[:SCALar]:NPOWer? | 6.81 |
| FETCh[:SCALar]:RFANalyzer:POWer? | 6.45 |
| FETCh[:SCALar]:RFGenerator:GLIStmode:EOList? | 6.54 |
| FETCh[:SCALar]:RFGenerator:GLIStmode:STATus? | 6.54 |
| FETCh[:SCALar]:WPOWer? | 6.77 |
| INItiate:IQRecorder | 6.82 |
| INItiate:IQSLot | 6.98 |
| INItiate:NPOWer | 6.78 |
| INItiate:POWer | 6.61 |
| INItiate:RFANalyzer | 6.43 |
| INItiate:RFGenerator | 6.46 |
| INItiate:RFGenerator | 6.51 |
| INItiate:RFGenerator:GLIStmode | 6.53 |
| INItiate:SPECTrum | 6.68 |
| INItiate:WPOWer | 6.76 |
| INPut[:STATe] | 6.56 |
| IQIF:DEFault | 6.60 |
| MMEMory:RECall:CURRent | 6.38 |
| MMEMory:SAVE:CURRent | 6.37 |
| OUTPut:AUXTx:OLEVel[:STATe] | 6.57 |
| OUTPut:AUXTx[:STATe] | 6.57 |
| OUTPut[:TX][:STATe] | 6.56 |
| READ:ARRay:IQRecorder:I? | 6.88 |
| READ:ARRay:IQRecorder:IQ? | 6.89 |
| READ:ARRay:IQRecorder:LEVel? | 6.87 |
| READ:ARRay:IQRecorder:PHASe? | 6.87 |
| READ:ARRay:IQRecorder:PL? | 6.88 |
| READ:ARRay:IQRecorder:Q? | 6.89 |
| READ:ARRay:IQSLot:I? | 6.104 |
| READ:ARRay:IQSLot:LEVel? | 6.104 |
| READ:ARRay:IQSLot:PHASe? | 6.104 |
| READ:ARRay:IQSLot:Q? | 6.104 |
| READ:ARRay:POWer:AVERAge? | 6.66 |
| READ:ARRay:POWer:MAXimum? | 6.66 |
| READ:ARRay:POWer:MINimum? | 6.66 |
| READ:ARRay:POWer:MINimum? | 6.66 |
| READ:ARRay:POWer[:CURRent]? | 6.66 |
| READ:ARRay:SPECTrum:AVERAge? | 6.74 |
| READ:ARRay:SPECTrum:MAXimum? | 6.74 |
| READ:ARRay:SPECTrum:MINimum? | 6.74 |
| READ:ARRay:SPECTrum:MINimum? | 6.74 |
| READ:ARRay:SPECTrum[:CURRent]? | 6.74 |
| READ:BINary:ARRay:IQRecorder:I? | 6.96 |
| READ:BINary:ARRay:IQRecorder:IQ? | 6.97 |
| READ:BINary:ARRay:IQRecorder:LEVel? | 6.94 |
| READ:BINary:ARRay:IQRecorder:PHASe? | 6.93 |
| READ:BINary:ARRay:IQRecorder:PL? | 6.95 |
| READ:BINary:ARRay:IQRecorder:Q? | 6.96 |
| READ:SUBarrays:IQRecorder:I? | 6.91 |
| READ:SUBarrays:IQRecorder:IQ? | 6.92 |
| READ:SUBarrays:IQRecorder:LEVel? | 6.90 |
| READ:SUBarrays:IQRecorder:PHASe? | 6.90 |
| READ:SUBarrays:IQRecorder:PL? | 6.91 |
| READ:SUBarrays:IQRecorder:Q? | 6.92 |
| READ:SUBarrays:IQSLot:I? | 6.105 |
| READ:SUBarrays:IQSLot:LEVel? | 6.105 |
| READ:SUBarrays:IQSLot:PHASe? | 6.105 |
| READ:SUBarrays:IQSLot:Q? | 6.105 |
| READ:SUBarrays:POWer:AVERAge? | 6.67 |
| READ:SUBarrays:POWer:MAXimum? | 6.67 |

| Command (RF, alphabetical) | Page |
|---|-------|
| READ:SUBarrays:POWer:MINimum? | 6.67 |
| READ:SUBarrays:POWer:MINimum? | 6.67 |
| READ:SUBarrays:POWer[:CURRent]? | 6.67 |
| READ:SUBarrays:SPECtrum:AVERage? | 6.75 |
| READ:SUBarrays:SPECtrum:MAXimum? | 6.75 |
| READ:SUBarrays:SPECtrum:MINimum? | 6.75 |
| READ:SUBarrays:SPECtrum:MINimum? | 6.75 |
| READ:SUBarrays:SPECtrum[:CURRent]? | 6.75 |
| READ[:SCALar]:NPOWer? | 6.81 |
| READ[:SCALar]:RFANalyzer:POWer? | 6.45 |
| READ[:SCALar]:WPOWer? | 6.77 |
| SAMPlE:ARRay:IQRecorder:I? | 6.88 |
| SAMPlE:ARRay:IQRecorder:IQ? | 6.89 |
| SAMPlE:ARRay:IQRecorder:LEVel? | 6.87 |
| SAMPlE:ARRay:IQRecorder:PHASe? | 6.87 |
| SAMPlE:ARRay:IQRecorder:PL? | 6.88 |
| SAMPlE:ARRay:IQRecorder:Q? | 6.89 |
| SAMPlE:ARRay:IQSLot:I? | 6.104 |
| SAMPlE:ARRay:IQSLot:LEVel? | 6.104 |
| SAMPlE:ARRay:IQSLot:PHASe? | 6.104 |
| SAMPlE:ARRay:IQSLot:Q? | 6.104 |
| SAMPlE:ARRay:POWer:AVERage? | 6.66 |
| SAMPlE:ARRay:POWer:MAXimum? | 6.66 |
| SAMPlE:ARRay:POWer:MINimum? | 6.66 |
| SAMPlE:ARRay:POWer[:CURRent]? | 6.66 |
| SAMPlE:ARRay:SPECtrum:AVERage? | 6.74 |
| SAMPlE:ARRay:SPECtrum:MAXimum? | 6.74 |
| SAMPlE:ARRay:SPECtrum:MINimum? | 6.74 |
| SAMPlE:ARRay:SPECtrum[:CURRent]? | 6.74 |
| SAMPlE:BINary:ARRay:IQRecorder:I? | 6.96 |
| SAMPlE:BINary:ARRay:IQRecorder:IQ? | 6.97 |
| SAMPlE:BINary:ARRay:IQRecorder:LEVel? | 6.94 |
| SAMPlE:BINary:ARRay:IQRecorder:PHASe? | 6.93 |
| SAMPlE:BINary:ARRay:IQRecorder:PL? | 6.95 |
| SAMPlE:BINary:ARRay:IQRecorder:Q? | 6.96 |
| SAMPlE:SUBarrays:IQRecorder:I? | 6.91 |
| SAMPlE:SUBarrays:IQRecorder:IQ? | 6.92 |
| SAMPlE:SUBarrays:IQRecorder:LEVel? | 6.90 |
| SAMPlE:SUBarrays:IQRecorder:PHASe? | 6.90 |
| SAMPlE:SUBarrays:IQRecorder:PL? | 6.91 |
| SAMPlE:SUBarrays:IQRecorder:Q? | 6.92 |
| SAMPlE:SUBarrays:IQSLot:I? | 6.105 |
| SAMPlE:SUBarrays:IQSLot:LEVel? | 6.105 |
| SAMPlE:SUBarrays:IQSLot:PHASe? | 6.105 |
| SAMPlE:SUBarrays:IQSLot:Q? | 6.105 |
| SAMPlE:SUBarrays:POWer:AVERage? | 6.67 |
| SAMPlE:SUBarrays:POWer:MAXimum? | 6.67 |
| SAMPlE:SUBarrays:POWer:MINimum? | 6.67 |
| SAMPlE:SUBarrays:POWer[:CURRent]? | 6.67 |
| SAMPlE:SUBarrays:SPECtrum:AVERage? | 6.75 |
| SAMPlE:SUBarrays:SPECtrum:MAXimum? | 6.75 |
| SAMPlE:SUBarrays:SPECtrum:MINimum? | 6.75 |
| SAMPlE:SUBarrays:SPECtrum[:CURRent]? | 6.75 |
| SAMPlE[:SCALar]:NPOWer? | 6.81 |
| SAMPlE[:SCALar]:RFANalyzer:POWer? | 6.45 |
| SAMPlE[:SCALar]:WPOWer? | 6.77 |
| [SENSe:]CORRection:LOSS:INPut<nr>[:MAGNitude] | 6.56 |
| [SENSe:]CORRection:LOSS:OUTPut<nr>:AUXTx:OLEVel[:MAGNitude] | 6.57 |
| [SENSe:]CORRection:LOSS:OUTPut<nr>:AUXTx[:MAGNitude] | 6.57 |
| [SENSe:]CORRection:LOSS:OUTPut<nr>[:TX][:MAGNitude] | 6.56 |
| [SENSe:]LEVel:ATTenuation | 6.40 |
| [SENSe:]LEVel:DEFault | 6.41 |
| [SENSe:]LEVel:MAXimum | 6.40 |

| Command (RF, alphabetical) | Page |
|--|------|
| [SENSe:]LEVel:MODE | 6.40 |
| [SENSe:]LEVel:REFerence | 6.41 |
| [SENSe:]NPOWer:BWIDth[:RESolution] | 6.80 |
| [SENSe:]POWer:FREQuency:BANdwidth[:RESolution] | 6.63 |
| [SENSe:]POWer:FREQuency:BWIDth[:RESolution] | 6.63 |
| [SENSe:]POWer:FREQuency:CENTer | 6.63 |
| [SENSe:]POWer:LEVel:RANGe | 6.63 |
| [SENSe:]POWer:TIME:DELay | 6.64 |
| [SENSe:]POWer:TIME:SPAN | 6.64 |
| [SENSe:]RFANalyzer:BANdwidth[:RESolution] | 6.43 |
| [SENSe:]RFANalyzer:BWIDth[:RESolution] | 6.43 |
| [SENSe:]RFANalyzer:FREQuency | 6.43 |
| [SENSe:]SPEctrum:DETEctor | 6.69 |
| [SENSe:]SPEctrum:FREQuency:BANdwidth[:RESolution] | 6.71 |
| [SENSe:]SPEctrum:FREQuency:BWIDth[:RESolution] | 6.71 |
| [SENSe:]SPEctrum:FREQuency:CENTer | 6.70 |
| [SENSe:]SPEctrum:FREQuency:SPAN | 6.70 |
| [SENSe:]SPEctrum:FREQuency:STARt | 6.70 |
| [SENSe:]SPEctrum:FREQuency:STOP | 6.70 |
| [SENSe:]SPEctrum:LEVel:RANGe | 6.71 |
| SOURce:CORRection:LOSS:INPut<nr>[:MAGNitude] | 6.56 |
| SOURce:CORRection:LOSS:OUTPut<nr>:AUXTx:OLEVel[:MAGNitude] | 6.57 |
| SOURce:CORRection:LOSS:OUTPut<nr>:AUXTx[:MAGNitude] | 6.57 |
| SOURce:CORRection:LOSS:OUTPut<nr>[:TX][:MAGNitude] | 6.56 |
| SOURce:DM:CLOCK:FREQuency | 6.58 |
| SOURce:DM:CLOCK:STATe | 6.58 |
| SOURce:RFGenerator:AUXTx:FREQuency | 6.53 |
| SOURce:RFGenerator:AUXTx:FREQuency | 6.53 |
| SOURce:RFGenerator:AUXTx:LEVel | 6.52 |
| SOURce:RFGenerator:AUXTx:LEVel:P<nr> | 6.52 |
| SOURce:RFGenerator:AUXTx:OLEVel | 6.52 |
| SOURce:RFGenerator:AUXTx:PATH? | 6.51 |
| SOURce:RFGenerator:BANdwidth | 6.50 |
| SOURce:RFGenerator:BWIDth | 6.50 |
| SOURce:RFGenerator:FHOPping:FREQuency | 6.49 |
| SOURce:RFGenerator:FHOPping:FREQuency:MODE | 6.49 |
| SOURce:RFGenerator:FHOPping:STATe | 6.49 |
| SOURce:RFGenerator:GLIStmode:DWELltime[?] | 6.54 |
| SOURce:RFGenerator:GLIStmode:FREQuency[500][?] | 6.55 |
| SOURce:RFGenerator:GLIStmode:PLEVel[500][?] | 6.55 |
| SOURce:RFGenerator:GLIStmode:STEPS[?] | 6.54 |
| SOURce:RFGenerator:LSMode:STATe | 6.50 |
| SOURce:RFGenerator:MODulation | 6.47 |
| SOURce:RFGenerator:MODulation:FM:DEVIation | 6.48 |
| SOURce:RFGenerator:MODulation:FM:FREQuency | 6.48 |
| SOURce:RFGenerator:MODulation:FMSTereo:AUDio:DEVIation | 6.48 |
| SOURce:RFGenerator:MODulation:FMSTereo:AUDio:FREQuency? | 6.48 |
| SOURce:RFGenerator:MODulation:FMSTereo:AUDio:MAPPING | 6.49 |
| SOURce:RFGenerator:MODulation:FMSTereo:PILot:DEVIation | 6.48 |
| SOURce:RFGenerator:MODulation:FMSTereo:PILot:FREQuency? | 6.48 |
| SOURce:RFGenerator:MODulation:SSB:FREQuency | 6.47 |
| SOURce:RFGenerator:MODulation[:AM]:INdex | 6.47 |
| SOURce:RFGenerator:PULSe:STATe | 6.50 |
| SOURce:RFGenerator[:TX]:FREQuency | 6.46 |
| SOURce:RFGenerator[:TX]:LEVel | 6.46 |
| STATus:OPERation:SYMBOLic:ENABLE | 6.38 |
| STATus:OPERation:SYMBOLic[:EVENT]? | 6.39 |
| STOP:IQRecorder | 6.82 |
| STOP:IQSLot | 6.98 |
| STOP:NPOWer | 6.78 |
| STOP:POWer | 6.61 |
| STOP:RFANalyzer | 6.43 |
| STOP:SPEctrum | 6.68 |

| Command (RF, alphabetical) | Page |
|--|------|
| STOP:WPOwer | 6.76 |
| SYSTem:OPTions:INFO:CURRent? | 6.37 |
| SYSTem:RESet:CURRent | 6.38 |
| TRIGger[:SEquence]:DEFault | 6.42 |
| TRIGger[:SEquence]:MTGap[?] | 6.42 |
| TRIGger[:SEquence]:SLOPe | 6.42 |
| TRIGger[:SEquence]:SOURce | 6.41 |
| TRIGger[:SEquence]:SOURce:EXTernal | 6.42 |
| TRIGger[:SEquence]:THReshold:IFPower | 6.42 |
| TRIGger[:SEquence]:THReshold:RFPower | 6.41 |

Table 6-6 Alphabetical list of remote-control commands: Audio

| Command (Audio, alphabetical) | Page |
|---|-------|
| ABORt:AFANalyzer:SECondary | 6.108 |
| ABORt:AFANalyzer[:PRIMary] | 6.108 |
| ABORt:AFGenerator:SECondary | 6.114 |
| ABORt:AFGenerator[:PRIMary] | 6.114 |
| ABORt:MULTitone:AF1Channel | 6.116 |
| ABORt:MULTitone:AF2Channel | 6.116 |
| ABORt:MULTitone:STEReo | 6.128 |
| ABORt:THD:AF1Channel | 6.140 |
| ABORt:THD:AF2Channel | 6.140 |
| ABORt:THD:STEReo | 6.145 |
| CALCulate:ARRay:MULTitone:AF1Channel:MATChing:LIMit? | 6.127 |
| CALCulate:ARRay:MULTitone:AF2Channel:MATChing:LIMit? | 6.127 |
| CALCulate:ARRay:MULTitone:STEReo:AF1Channel:MATChing:LIMit? | 6.139 |
| CALCulate:ARRay:MULTitone:STEReo:AF2Channel:MATChing:LIMit? | 6.139 |
| CALCulate:ARRay:MULTitone:STEReo:MATChing:LIMit? | 6.139 |
| CALCulate[:SCALar]:MULTitone:AF1Channel:MATChing:LIMit? | 6.127 |
| CALCulate[:SCALar]:MULTitone:AF1Channel:TONE<nr>:MATChing:LIMit? | 6.127 |
| CALCulate[:SCALar]:MULTitone:AF2Channel:MATChing:LIMit? | 6.127 |
| CALCulate[:SCALar]:MULTitone:AF2Channel:TONE<nr>:MATChing:LIMit? | 6.127 |
| CALCulate[:SCALar]:MULTitone:STEReo:AF1Channel:MATChing:LIMit? | 6.138 |
| CALCulate[:SCALar]:MULTitone:STEReo:AF1Channel:TONE<nr>:MATChing:LIMit? | 6.138 |
| CALCulate[:SCALar]:MULTitone:STEReo:AF2Channel:MATChing:LIMit? | 6.138 |
| CALCulate[:SCALar]:MULTitone:STEReo:AF2Channel:TONE<nr>:MATChing:LIMit? | 6.138 |
| CALCulate[:SCALar]:MULTitone:STEReo:MATChing:LIMit? | 6.139 |
| CALCulate[:SCALar]:MULTitone:STEReo:TONE<nr>:MATChing:LIMit? | 6.138 |
| CONFigure:AFANalyzer:SECondary:CONTRol:COUPling | 6.110 |
| CONFigure:AFANalyzer:SECondary:CONTRol:DISTRortion[:FREQuency] | 6.110 |
| CONFigure:AFANalyzer:SECondary:CONTRol:REPetition | 6.110 |
| CONFigure:AFANalyzer:SECondary:EREPorting | 6.108 |
| CONFigure:AFANalyzer:SECondary:FILTer:BPASs:ACCoupling | 6.112 |
| CONFigure:AFANalyzer:SECondary:FILTer:BPASs:DCCoupling | 6.113 |
| CONFigure:AFANalyzer:SECondary:FILTer:VBPass:BWIDth | 6.111 |
| CONFigure:AFANalyzer:SECondary:FILTer:VBPass:CFRequency | 6.111 |
| CONFigure:AFANalyzer:SECondary:FILTer:WEIGHting | 6.111 |
| CONFigure:AFANalyzer:SECondary:MTReduce | 6.109 |
| CONFigure:AFANalyzer[:PRIMary]:CONTRol:COUPling | 6.110 |
| CONFigure:AFANalyzer[:PRIMary]:CONTRol:DISTRortion[:FREQuency] | 6.110 |
| CONFigure:AFANalyzer[:PRIMary]:CONTRol:REPetition | 6.110 |
| CONFigure:AFANalyzer[:PRIMary]:EREPorting | 6.108 |
| CONFigure:AFANalyzer[:PRIMary]:FILTer:BPASs:ACCoupling | 6.112 |
| CONFigure:AFANalyzer[:PRIMary]:FILTer:BPASs:DCCoupling | 6.113 |
| CONFigure:AFANalyzer[:PRIMary]:FILTer:VBPass:BWIDth | 6.111 |
| CONFigure:AFANalyzer[:PRIMary]:FILTer:VBPass:CFRequency | 6.111 |
| CONFigure:AFANalyzer[:PRIMary]:FILTer:WEIGHting | 6.111 |
| CONFigure:AFANalyzer[:PRIMary]:MTReduce | 6.109 |

| Command (Audio, alphabetical) | Page |
|--|-------|
| CONFigure: MULTitone: AF1Channel: AFGLead | 6.118 |
| CONFigure: MULTitone: AF1Channel: CONTrol: REPetition | 6.118 |
| CONFigure: MULTitone: AF1Channel: COUPling | 6.117 |
| CONFigure: MULTitone: AF1Channel: EREPorting | 6.117 |
| CONFigure: MULTitone: AF1Channel: FILTer: BPASs: ACCoupling | 6.125 |
| CONFigure: MULTitone: AF1Channel: FILTer: BPASs: DCCoupling | 6.124 |
| CONFigure: MULTitone: AF1Channel: FILTer: WEIGHting | 6.125 |
| CONFigure: MULTitone: AF1Channel: LIMit: LINE: ASYMmetric: LOWer | 6.121 |
| CONFigure: MULTitone: AF1Channel: LIMit: LINE: ASYMmetric: UPPer | 6.120 |
| CONFigure: MULTitone: AF1Channel: RLEVel | 6.117 |
| CONFigure: MULTitone: AF1Channel: RMODe | 6.118 |
| CONFigure: MULTitone: AF1Channel: TDEFinition | 6.122 |
| CONFigure: MULTitone: AF1Channel: TDEFinition: MODE | 6.123 |
| CONFigure: MULTitone: AF1Channel: TDEFinition: TLEVel | 6.123 |
| CONFigure: MULTitone: AF1Channel: TDEFinition: TONE<nr> | 6.123 |
| CONFigure: MULTitone: AF1Channel: TONE<nr>: LIMit: LINE: ASYMmetric: LOWer | 6.121 |
| CONFigure: MULTitone: AF1Channel: TONE<nr>: LIMit: LINE: ASYMmetric: UPPer | 6.120 |
| CONFigure: MULTitone: AF2Channel: AFGLead | 6.118 |
| CONFigure: MULTitone: AF2Channel: CONTrol: REPetition | 6.118 |
| CONFigure: MULTitone: AF2Channel: COUPling | 6.117 |
| CONFigure: MULTitone: AF2Channel: EREPorting | 6.117 |
| CONFigure: MULTitone: AF2Channel: FILTer: BPASs: ACCoupling | 6.125 |
| CONFigure: MULTitone: AF2Channel: FILTer: BPASs: ACCoupling | 6.136 |
| CONFigure: MULTitone: AF2Channel: FILTer: BPASs: DCCoupling | 6.124 |
| CONFigure: MULTitone: AF2Channel: FILTer: WEIGHting | 6.125 |
| CONFigure: MULTitone: AF2Channel: LIMit: LINE: ASYMmetric: LOWer | 6.121 |
| CONFigure: MULTitone: AF2Channel: LIMit: LINE: ASYMmetric: UPPer | 6.120 |
| CONFigure: MULTitone: AF2Channel: RLEVel | 6.117 |
| CONFigure: MULTitone: AF2Channel: RMODe | 6.118 |
| CONFigure: MULTitone: AF2Channel: TDEFinition | 6.122 |
| CONFigure: MULTitone: AF2Channel: TDEFinition: MODE | 6.123 |
| CONFigure: MULTitone: AF2Channel: TDEFinition: TLEVel | 6.123 |
| CONFigure: MULTitone: AF2Channel: TDEFinition: TONE<nr> | 6.123 |
| CONFigure: MULTitone: AF2Channel: TONE<nr>: LIMit: LINE: ASYMmetric: LOWer | 6.121 |
| CONFigure: MULTitone: AF2Channel: TONE<nr>: LIMit: LINE: ASYMmetric: UPPer | 6.120 |
| CONFigure: MULTitone: STEReo: AFGLead | 6.130 |
| CONFigure: MULTitone: STEReo: CONTrol: REPetition | 6.129 |
| CONFigure: MULTitone: STEReo: COUPling | 6.129 |
| CONFigure: MULTitone: STEReo: EREPorting | 6.128 |
| CONFigure: MULTitone: STEReo: FILTer: BPASs: ACCoupling | 6.136 |
| CONFigure: MULTitone: STEReo: FILTer: BPASs: DCCoupling | 6.135 |
| CONFigure: MULTitone: STEReo: FILTer: WEIGHting | 6.136 |
| CONFigure: MULTitone: STEReo: LIMit: LINE: ASYMmetric: LOWer | 6.132 |
| CONFigure: MULTitone: STEReo: LIMit: LINE: ASYMmetric: UPPer | 6.131 |
| CONFigure: MULTitone: STEReo: RLEVel | 6.129 |
| CONFigure: MULTitone: STEReo: RMODe | 6.130 |
| CONFigure: MULTitone: STEReo: TDEFinition | 6.133 |
| CONFigure: MULTitone: STEReo: TDEFinition: MODE | 6.134 |
| CONFigure: MULTitone: STEReo: TDEFinition: TLEVel | 6.134 |
| CONFigure: MULTitone: STEReo: TDEFinition: TONE<nr> | 6.134 |
| CONFigure: MULTitone: STEReo: TONE<nr>: LIMit: LINE: ASYMmetric: LOWer | 6.132 |
| CONFigure: MULTitone: STEReo: TONE<nr>: LIMit: LINE: ASYMmetric: UPPer | 6.131 |
| CONFigure: SUBarrays: MULTitone: AF1Channel | 6.119 |
| CONFigure: SUBarrays: MULTitone: AF2Channel | 6.119 |
| CONFigure: THD: AF1Channel: CONTrol: REPetition | 6.141 |
| CONFigure: THD: AF1Channel: COUPling | 6.142 |
| CONFigure: THD: AF1Channel: EREPorting | 6.140 |
| CONFigure: THD: AF1Channel: FILTer: BPASs: ACCoupling | 6.143 |
| CONFigure: THD: AF1Channel: FILTer: BPASs: DCCoupling | 6.143 |
| CONFigure: THD: AF1Channel: FILTer: WEIGHting | 6.144 |
| CONFigure: THD: AF1Channel: HARMonics<nr> | 6.142 |
| CONFigure: THD: AF1Channel: TDEFinition | 6.142 |
| CONFigure: THD: AF2Channel: CONTrol: REPetition | 6.141 |

| Command (Audio, alphabetical) | Page |
|---|-------|
| CONFigure:THD:AF2Channel:COUPling..... | 6.142 |
| CONFigure:THD:AF2Channel:EREPorting..... | 6.140 |
| CONFigure:THD:AF2Channel:FILTer:BPASs:ACCoupling..... | 6.143 |
| CONFigure:THD:AF2Channel:FILTer:BPASs:DCCoupling..... | 6.143 |
| CONFigure:THD:AF2Channel:FILTer:WEIGHting..... | 6.144 |
| CONFigure:THD:AF2Channel:HARMonics<nr>..... | 6.142 |
| CONFigure:THD:AF2Channel:TDEFinition..... | 6.142 |
| CONFigure:THD:STEReo:CONTRol:REPetition..... | 6.146 |
| CONFigure:THD:STEReo:EREPorting..... | 6.146 |
| CONFigure:THD:STEReo:HARMonics<nr>..... | 6.147 |
| CONFigure:THD:STEReo:TDEFinition..... | 6.147 |
| CONTInue:AFANalyzer:SECondary..... | 6.108 |
| CONTInue:AFANalyzer[:PRIMary]..... | 6.108 |
| CONTInue:MULTitone:AF1Channel..... | 6.116 |
| CONTInue:MULTitone:AF2Channel..... | 6.116 |
| CONTInue:MULTitone:STEReo..... | 6.128 |
| CONTInue:THD:AF1Channel..... | 6.140 |
| CONTInue:THD:AF2Channel..... | 6.140 |
| CONTInue:THD:STEReo..... | 6.145 |
| DEFault:MULTitone:AF1Channel:FILTer..... | 6.125 |
| DEFault:MULTitone:AF1Channel:LIMit:LINE..... | 6.121 |
| DEFault:MULTitone:AF1Channel:TDEFinition..... | 6.124 |
| DEFault:MULTitone:AF2Channel:FILTer..... | 6.125 |
| DEFault:MULTitone:AF2Channel:LIMit:LINE..... | 6.121 |
| DEFault:MULTitone:AF2Channel:TDEFinition..... | 6.124 |
| DEFault:MULTitone:FILTer..... | 6.126 |
| DEFault:MULTitone:LIMit:LINE..... | 6.122 |
| DEFault:MULTitone:STEReo:FILTer..... | 6.136 |
| DEFault:MULTitone:STEReo:LIMit:LINE..... | 6.132 |
| DEFault:MULTitone:STEReo:TDEFinition..... | 6.135 |
| DEFault:MULTitone:TDEFinition..... | 6.124 |
| DEFault:THD:AF1Channel:FILTer..... | 6.144 |
| DEFault:THD:AF2Channel:FILTer..... | 6.144 |
| DEFault:THD:FILTer..... | 6.144 |
| DISPlay:MULTitone:AF1Channel:GRID..... | 6.117 |
| DISPlay:MULTitone:AF2Channel:GRID..... | 6.117 |
| FETCh:AFANalyzer:SECondary:STATus?..... | 6.109 |
| FETCh:AFANalyzer[:PRIMary]:STATus?..... | 6.109 |
| FETCh:AFGenerator:SECondary:STATus?..... | 6.115 |
| FETCh:AFGenerator[:PRIMary]:STATus?..... | 6.115 |
| FETCh:ARRay:MULTitone:AF1Channel?..... | 6.126 |
| FETCh:ARRay:MULTitone:AF2Channel?..... | 6.126 |
| FETCh:ARRay:MULTitone:STEReo:AF1Channel?..... | 6.137 |
| FETCh:ARRay:MULTitone:STEReo:AF2Channel?..... | 6.137 |
| FETCh:ARRay:MULTitone:STEReo?..... | 6.138 |
| FETCh:ARRay:THD:AF1Channel?..... | 6.145 |
| FETCh:ARRay:THD:AF2Channel?..... | 6.145 |
| FETCh:ARRay:THD:STEReo:AF1Channel?..... | 6.148 |
| FETCh:ARRay:THD:STEReo:AF2Channel?..... | 6.148 |
| FETCh:ARRay:THD:STEReo?..... | 6.148 |
| FETCh:MULTitone:AF1Channel:STATus?..... | 6.117 |
| FETCh:MULTitone:AF2Channel:STATus?..... | 6.117 |
| FETCh:MULTitone:STEReo:STATus?..... | 6.128 |
| FETCh:SUBarrays:MULTitone:AF1Channel?..... | 6.127 |
| FETCh:SUBarrays:MULTitone:AF2Channel?..... | 6.127 |
| FETCh:THD:AF1Channel:STATus?..... | 6.141 |
| FETCh:THD:AF2Channel:STATus?..... | 6.141 |
| FETCh:THD:STEReo:STATus?..... | 6.146 |
| FETCh[:SCALar]:AFANalyzer:SECondary?..... | 6.114 |
| FETCh[:SCALar]:AFANalyzer[:PRIMary]?..... | 6.114 |
| FETCh[:SCALar]:MULTitone:AF1Channel:TONE<nr>?..... | 6.126 |
| FETCh[:SCALar]:MULTitone:AF2Channel:TONE<nr>?..... | 6.126 |
| FETCh[:SCALar]:MULTitone:STEReo:AF1Channel:TONE<nr>?..... | 6.137 |

| Command (Audio, alphabetical) | Page |
|--|-------|
| FETCh[:SCALar]:MULTitone:STEReo:AF2Channel:TONE<nr>? | 6.137 |
| FETCh[:SCALar]:MULTitone:STEReo:TONE<nr>? | 6.137 |
| FETCh[:SCALar]:THD:AF1Channel:HARMonic<nr>? | 6.144 |
| FETCh[:SCALar]:THD:AF1Channel:THD? | 6.145 |
| FETCh[:SCALar]:THD:AF2Channel:HARMonic<nr>? | 6.144 |
| FETCh[:SCALar]:THD:AF2Channel:THD? | 6.145 |
| FETCh[:SCALar]:THD:STEReo:AF1Channel:HARMonic<nr>? | 6.148 |
| FETCh[:SCALar]:THD:STEReo:AF1Channel:THD? | 6.149 |
| FETCh[:SCALar]:THD:STEReo:AF2Channel:HARMonic<nr>? | 6.148 |
| FETCh[:SCALar]:THD:STEReo:AF2Channel:THD? | 6.149 |
| FETCh[:SCALar]:THD:STEReo:HARMonic<nr>? | 6.148 |
| FETCh[:SCALar]:THD:STEReo:THD? | 6.149 |
| INITiate:AFANalyzer:SECondary | 6.108 |
| INITiate:AFANalyzer[:PRIMary] | 6.108 |
| INITiate:AFGenerator:SECondary | 6.114 |
| INITiate:AFGenerator[:PRIMary] | 6.114 |
| INITiate:MULTitone:AF1Channel | 6.116 |
| INITiate:MULTitone:AF2Channel | 6.116 |
| INITiate:MULTitone:STEReo | 6.128 |
| INITiate:THD:AF1Channel | 6.140 |
| INITiate:THD:AF2Channel | 6.140 |
| INITiate:THD:STEReo | 6.145 |
| MMEMory:RECall:CURRent | 6.38 |
| MMEMory:SAVE:CURRent | 6.37 |
| READ:ARRay:MULTitone:AF1Channel? | 6.126 |
| READ:ARRay:MULTitone:AF2Channel? | 6.126 |
| READ:ARRay:MULTitone:STEReo:AF1Channel? | 6.137 |
| READ:ARRay:MULTitone:STEReo:AF2Channel? | 6.137 |
| READ:ARRay:MULTitone:STEReo? | 6.138 |
| READ:ARRay:THD:AF1Channel? | 6.145 |
| READ:ARRay:THD:AF2Channel? | 6.145 |
| READ:ARRay:THD:STEReo:AF1Channel? | 6.148 |
| READ:ARRay:THD:STEReo:AF2Channel? | 6.148 |
| READ:ARRay:THD:STEReo? | 6.148 |
| READ:SUBarrays:MULTitone:AF1Channel? | 6.127 |
| READ:SUBarrays:MULTitone:AF2Channel? | 6.127 |
| READ[:SCALar]:AFANalyzer:SECondary? | 6.114 |
| READ[:SCALar]:AFANalyzer[:PRIMary]? | 6.114 |
| READ[:SCALar]:MULTitone:AF1Channel:TONE<nr>? | 6.126 |
| READ[:SCALar]:MULTitone:AF2Channel:TONE<nr>? | 6.126 |
| READ[:SCALar]:MULTitone:STEReo:AF1Channel:TONE<nr>? | 6.137 |
| READ[:SCALar]:MULTitone:STEReo:AF2Channel:TONE<nr>? | 6.137 |
| READ[:SCALar]:MULTitone:STEReo:TONE<nr>? | 6.137 |
| READ[:SCALar]:THD:AF1Channel:HARMonic<nr>? | 6.144 |
| READ[:SCALar]:THD:AF1Channel:THD? | 6.145 |
| READ[:SCALar]:THD:AF2Channel:HARMonic<nr>? | 6.144 |
| READ[:SCALar]:THD:AF2Channel:THD? | 6.145 |
| READ[:SCALar]:THD:STEReo:AF1Channel:HARMonic<nr>? | 6.148 |
| READ[:SCALar]:THD:STEReo:AF1Channel:THD? | 6.149 |
| READ[:SCALar]:THD:STEReo:AF2Channel:HARMonic<nr>? | 6.148 |
| READ[:SCALar]:THD:STEReo:AF2Channel:THD? | 6.149 |
| READ[:SCALar]:THD:STEReo:HARMonic<nr>? | 6.148 |
| READ[:SCALar]:THD:STEReo:THD? | 6.149 |
| [SENSe]:JAFLevel:DEFault | 6.108 |
| [SENSe]:JAFLevel:SECondary:MAXimum | 6.107 |
| [SENSe]:JAFLevel:SECondary:MODE | 6.107 |
| [SENSe]:JAFLevel[:PRIMary]:MAXimum | 6.107 |
| [SENSe]:JAFLevel[:PRIMary]:MODE | 6.107 |
| SOURce:AFGenerator:SECondary:FREQuency | 6.115 |
| SOURce:AFGenerator:SECondary:LEVel | 6.115 |
| SOURce:AFGenerator:SECondary:SMODE | 6.115 |
| SOURce:AFGenerator[:PRIMary]:FREQuency | 6.115 |
| SOURce:AFGenerator[:PRIMary]:LEVel | 6.115 |

| Command (Audio, alphabetical) | Page |
|--|-------|
| SOURce:AFGenerator[:PRIMary]:SMODE | 6.115 |
| STATus:OPERation:SYMBOLic:ENABLE..... | 6.38 |
| STATus:OPERation:SYMBOLic[:EVENT]? | 6.39 |
| STOP:AFANalyzer:SECondary | 6.108 |
| STOP:AFANalyzer:SECondary | 6.108 |
| STOP:MULTitone:AF1Channel | 6.116 |
| STOP:MULTitone:AF2Channel | 6.116 |
| STOP:MULTitone:STEReo..... | 6.128 |
| STOP:THD:AF1Channel | 6.140 |
| STOP:THD:AF2Channel | 6.140 |
| STOP:THD:STEReo..... | 6.145 |
| SYSTem:OPTions:INFO:CURRent? | 6.37 |
| SYSTem:RESet:CURRent | 6.38 |

Contents

- 7 Remote Control – Program Examples 7.1**
 - Secondary Address Handling7.1**
 - Simple Measurements7.2
 - Measuring the I/Q Spectrum of a Mobile.....7.3**
 - Symbolic Status Event Register Evaluation7.5**
 - Tips and Tricks for CMU Programming7.7**

7 Remote Control – Program Examples

The program examples in this chapter are intended to give a short introduction to GPIB bus programming of the CMU illustrating some of the concepts discussed in Chapter 5. For examples involving optional function groups (network tests) refer to the relevant manuals, e.g. *CMU-K21/-K22/-K23*.

Secondary Address Handling

The following example explains how to handle primary and secondary addressing and how to perform a simple measurement with the CMU. In the example, remote control via the *National Instruments* GPIB bus driver (NI-488.2) and the programming language C is used. Once the addresses are assigned, the same commands can be used in different function groups.

```
// Include header files
#include <string.h>

/* NI488.2 header file */
#include <decl.h>

// GPIB board index
#define BdIndx          0

// Primary address
#define pad             20

// Secondary address for Base Definition (National Instruments specific)
#define sad_BASE        96

// Secondary Address for function groups definition
// (conforming to IEEE488.2)
#define _RF_NSig        1
#define _GSM900MS_Sig  2
#define _GSM900MS_NSig 3
#define _GSM1800MS_Sig 4

#define sad_RF_NSig      sad_BASE + _RF_NSig
#define sad_GSM900MS_Sig sad_BASE + _GSM900MS_Sig
#define sad_GSM900MS_NSig sad_BASE + _GSM900MS_NSig
#define sad_GSM1800MS_Sig sad_BASE + _GSM1800MS_Sig

// Timeout
#define tmo              (int) 10

// EOT
#define eot              (int) 1

// EOS
#define eos              (int) 0

// Command definition for secondary address mapping
```

```

#define Map_Command                "SYST:REM:ADDR:SEC %d,\"%s\""

#define IdStr_RF_NSig              "RF_NSig"
#define IdStr_GSM900MS_Sig        "GSM900MS_Sig"
#define IdStr_GSM900MS_NSig      "GSM900MS_NSig"
#define IdStr_GSM1800MS_Sig      "GSM1800MS_Sig "

// Variable declarations
int h_BASE;
int h_RF_NSig;
int h_GSM900MS_Sig;
int h_GSM900MS_NSig;
int h_GSM1800MS_Sig;

char InBuffer [100];
char Command [100];

// Request of the basesystem handle
h_BASE = ibdev (BdIndx, pad, sad_BASE, tmo, eot, eos);

// Mapping of secondary addresses for the function groups
sprintf (Command, Map_Command, _RF_NSig, IdStr_RF_NSig);
ibwrt(h_BASE, Command, strlen(Command));
sprintf (Command, Map_Command, _GSM900MS_Sig, IdStr_GSM900MS_Sig);
ibwrt(h_BASE, Command, strlen(Command));
sprintf (Command, "Map_Command _GSM900MS_NSig, IdStr_GSM900MS_NSig);
ibwrt(h_BASE, Command, strlen(Command));
sprintf (Command, "Map_Command _GSM1800MS_Sig, IdStr_GSM1800MS_Sig);
ibwrt(h_BASE, Command, strlen(Command));

// Request of function group handles
h_RF_NSig = ibdev (BdIndx, pad, sad_RF_NSig, tmo, eot, eos);
h_GSM900MS_Sig = ibdev (BdIndx, pad, sad_GSM900MS_Sig, tmo, eot, eos);
h_GSM900MS_NSig = ibdev (BdIndx, pad, sad_GSM900MS_NSig, tmo, eot, eos);
h_GSM1800MS_Sig = ibdev (BdIndx, pad, sad_GSM1800MS_Sig, tmo, eot, eos);

```

Simple Measurements

The following measurement examples require option CMU-K21/-K22/-K23 to be installed – see separate operating manual for GSM900/1800/1900 mobile tests.

```

// Example for a GSM900 mobile with power and
// modulation measurement at PCL 5 and PCL 10

ibwrt(h_GSM900MS_Sig, "PROC:SIGN:MS:PCL 5", 18);
ibwrt(h_GSM900MS_Sig, "READ:SCAL:POW:RES?", 18);
ibrd (h_GSM900MS_Sig, InBuffer, sizeof (InBuffer));
...
ibwrt(h_GSM900MS_Sig, "READ:SCAL:MOD:RES?", 18);
ibrd (h_GSM900MS_Sig, InBuffer, sizeof (InBuffer));
...
ibwrt(h_GSM900MS_Sig, "PROC:SIGN:MS:PCL 10", 19);

```



```

ibwrt(h_GSM900MS_Sig, "READ:SCAL:POW:RES?",18);
ibrdr (h_GSM900MS_Sig, InBuffer,sizeof (InBuffer));
...
ibwrt(h_GSM900MS_Sig, "READ:SCAL:MOD:RES?",18);
ibrdr (h_GSM900MS_Sig, InBuffer,sizeof (InBuffer));
...

// Example for a GSM1800 mobile with a power and
// modulation measurement at PCL 5 and PCL 10

ibwrt(h_GSM1800MS_Sig, "PROC:SIGN:MS:PCL 5",18);
ibwrt(h_GSM1800MS_Sig, "READ:SCAL:POW:RES?",18);
ibrdr (h_GSM1800MS_Sig, InBuffer,sizeof (InBuffer));
...
ibwrt(h_GSM1800MS_Sig, "READ:SCAL:MOD:RES?",18);
ibrdr (h_GSM1800MS_Sig, InBuffer,sizeof (InBuffer));
...
ibwrt(h_GSM1800MS_Sig, "PROC:SIGN:MS:PCL 10",19);
ibwrt(h_GSM1800MS_Sig, "READ:SCAL:POW:RES?",18);
ibrdr (h_GSM1800MS_Sig, InBuffer,sizeof (InBuffer));
...
ibwrt(h_GSM1800MS_Sig, "READ:SCAL:MOD:RES?",18);
ibrdr (h_GSM1800MS_Sig, InBuffer,sizeof (InBuffer));

```

Measuring the I/Q Spectrum of a Mobile

GSM uses the GMSK modulation scheme with a symbol rate of 270.833 kBit/s and four different phases that can be occupied during one symbol interval. If a constant series of zeros or ones is transmitted, the rotation of the I/Q vector causes a side band at $270.833/4 \text{ Hz} = 667.70825 \text{ Hz}$ from the carrier. Compared to the side band, the original carrier frequency is suppressed by -30 dB to -40 dB . The following example program measures the carrier signal, the upper and the lower side band using the *RF Spectrum* and the *RF Power vs Time* measurement groups. No additional options are needed.

To keep the syntax as short and simple as possible, the programs were written with the aid of *Winbatch*, a batch job tool organizing and simplifying the transfer of commands and data between the controller and the instrument.

Winbatch uses device names such as *CMUBASE*, *CMUGSMNS*, *CMUGSMSIG* which are previously defined and assigned to the primary address, secondary address, and some general device settings. With these device names, a complete command line reads:

```
CMUBASE: <CMU_Command>
```

where *<CMU_Command>* may be any of the commands (setting commands or queries) specified within the function group and mode identified by the device name *CMUBASE*. Program sequences consisting of commands that are defined in several function groups and modes can be re-used with an exchanged device name.

In addition to these data transfer commands, *Winbatch* provides *WHILE*, *GOTO*, and *IF* statements to express conditions and define loops. Program examples utilizing these statements can be found in the manuals for network tests, e.g. *GSM900/1800/1900-MS*. For the following example, configure your *Winbatch* settings such that *CMUBASE* is the device name for the CMU *BASE* system and *CMURF* denotes function group *RF (Non Signalling)*.

```

ECHO ON

FPRINT .....
FPRINT  INITIALISATION ROUTINE:
FPRINT  ASK FOR THE IDENTIFIER OF THE CMU, RESET THE INSTRUMENT,
FPRINT  DEFINE THE SECONDARY ADDRESSES FOR ALL AVAILABLE FUNCTION GROUPS
FPRINT .....

CMUBASE: *IDN?           Identification query
CMUBASE: *RST;*OPC?     Reset the instrument; prevent the following command
                        to be executed before *RST is complete
CMUBASE: *CLS           Clear output buffer, set status byte
CMUBASE: SYST:REM:ADDR:SEC 1,"RF_NSig" Define function group RF Non Signalling; the CMU Base
                        system is always assigned secondary address 0

FPRINT .....
FPRINT  CONNECTORS
FPRINT .....

CMURF: INP:STAT RF2     Define input connector RF2
CMURF: OUTP:STAT RF2   Define output connector RF2

FPRINT .....
FPRINT  RF GENERATOR SETTINGS
FPRINT .....

CMURF: SOUR:RFG:FREQ 900 MHZ      Set RF generator frequency
CMURF: SOUR:RFG:MOD SSB           Switch on frequency offset (single side band modulation)
CMURF: SOUR:RFG:MOD:SSB:FREQ 67.7 KHZ Set offset frequency
CMURF: INIT:RFG;*OPC?           Switch on RF generator

FPRINT .....
FPRINT  SPECTRUM ANALYZER SETTINGS
FPRINT  REFERENCE LEVEL ONLY EXISTS IN THE MANUAL MODE (Defines display area)
FPRINT .....

CMURF: SENS:SPEC:FREQ:CENT 900 MHZ      Set center frequency for spectrum measurement
CMURF: SENS:SPEC:FREQ:SPAN 500 KHZ      Set frequency span
CMURF: SENS:SPEC:FREQ:BAND 20 KHZ       Set resolution bandwidth of the spectrum analyzer
CMURF: CONF:SPEC:CONT:REP SING,NONE,NONE Single shot measurement, no stop on error

FPRINT .....
FPRINT  SPECTRUM MEASUREMENT AT 900 MHZ + OFFSET 67.7 KHZ, 1 POINT
FPRINT .....

CMURF: CONF:ARR:SPEC:RANG 900.0677 MHZ,1 Select single measurement point at 900.0677 MHz
CMURF: READ:ARR:SPEC?           Start single shot spectrum measurement, wait until it is
                                terminated, and return result (1 value)

FPRINT .....
FPRINT  HAVE A LOOK AT SPECIFIC OFFSETS (SUPPRESSED CARRIER AT 900 MHZ)
FPRINT .....

CMURF: CONF:ARR:SPEC:RANG 900 MHZ,1     Select single measurement point
CMURF: READ:ARR:SPEC?           Start single shot spectrum measurement, wait until it is
                                terminated, and return result (1 value)

FPRINT .....
FPRINT  HAVE A LOOK AT SPECIFIC OFFSETS (THE OTHER SIDEBAND 900 MHZ - 67.7 KHZ)
FPRINT .....

CMURF: CONF:ARR:SPEC:RANG 899.9323 MHZ,1 Select single measurement point
CMURF: READ:ARR:SPEC?           Start single shot spectrum measurement, wait until it is
                                terminated, and return result (1 value)

FPRINT .....

```

```

CMURF: ABOR:SPEC                               Abort spectrum measurement and free resources

FPRINT .....
FPRINT  PRODUCE A RAMPED SIGNAL
FPRINT .....

CMURF: SOUR:RFG:PULS:STAT ON;*OPC?            Select pulsed signal (as opposed to CW)

FPRINT .....
FPRINT  CONFIGURE THE POWER/T MEASUREMENT
FPRINT .....

CMURF: SENS:POW:FREQ:CENT 900.0677 MHZ        Set center frequency for power vs. time measurement
CMURF: SENS:POW:FREQ:BAND 20 KHZ              Set resolution bandwidth of the RF analyzer
CMURF: SENS:POW:TIME:SPAN 1MS                 Set evaluation time of power measurement
CMURF: TRIG:SOUR IFP                          Trigger meas. by IF signal level (recommended)
CMURF: LEV:MAX -10                            Set expected maximum input level

CMURF: CONF:ARR:POW:RANG 3E-4,1              Select single measurement point at 0.3 ms
CMURF: CONF:POW:CONT:REP SING,NONE,NONE       Single shot measurement, no stop on error
CMURF: SYST:ERR?                              Read error queue
CMURF: INIT:POW                               Initiate power vs. time measurement

CMURF: READ:ARR:POW?                          Start single shot measurement, wait until it is
                                              terminated, and return result (1 value)

FPRINT .....
FPRINT  HAVE A LOOK AT SPECIFIC OFFSETS (SUPPRESSED CARRIER AT 900 MHZ)
FPRINT .....

CMURF: SENS:POW:FREQ:CENT 900 MHZ            Set center frequency for power vs. time measurement
CMURF: READ:ARR:POW?                          Start single shot measurement, wait until it is
                                              terminated, and return result (1 value)

FPRINT .....
FPRINT  HAVE A LOOK AT SPECIFIC OFFSETS (THE OTHER SIDEBAND 900 MHZ - 67.7 KHZ)
FPRINT .....

CMURF: SENS:POW:FREQ:CENT 899.9323 MHZ       Set center frequency for power vs. time measurement
CMURF: READ:ARR:POW?                          Start single shot measurement, wait until it is
                                              terminated, and return result (1 value)

SETLOCAL                                       Quit remote control mode

```

Symbolic Status Event Register Evaluation

The following example program shows how the **EVENT** part of the **STATUS:OPERation** registers can be read using the commands for symbolic status register evaluation typed in boldface. The program provokes and evaluates the event *Reference Frequency Not Locked (RFNL)* which is reported by bit no. 6 of the **STATUS:OPERation:CMU:SUM1:CMU1** sub-register assigned to the CMU base system (see sections *Symbolic Status Event Register Evaluation* and *STATUS:OPERation Register* in chapter 5).

```

CMUBASE: *RST;*OPC?                        Reset the instrument; prevent the following command
                                              from being executed before *RST is complete
CMUBASE: *CLS                               Clear output buffer, set status byte
CMUBASE: CONF:SYNC:FREQ:REF:MODE?
CMUBASE: CONF:SYNC:FREQ:REF:MODE EXT       Provoke event -> Reference Frequency Not Locked
                                              (external reference frequency selected but no
                                              external input signal available)

```

| | |
|--|--|
| CMUBASE: TRACE:REMOTE:MODE:FILE ON | Remote trace to file |
| CMUBASE: TRACE:REMOTE:MODE:DISPLAY ON | Remote trace display ON |
| CMUBASE: TRACE:REMOTE:MODE:SRQ ON | Display SRQ event on remote trace window |
| CMUBASE: STATUS:PRESET | Reset status register system |
| CMUBASE: *STB? | Check status byte |
| CMUBASE: *SRE? | Check service request enable |
| CMUBASE: *SRE 128 | Service request for OPERATION register |
| CMUBASE: *STB? | Check status byte |
| CMUBASE: STAT:OPER:SYMB:ENAB? | Check symbolic status register enable --> NONE |
| | |
| CMUBASE: STAT:OPER:SYMB:ENAB RFNL | Enable symbolic status register evaluation (event Reference Frequency Not Locked = RFNL) |
| | |
| [l_LOOP] | |
| if CMUBASE: *STB? <> 0 goto read_event | Read STB Bit 7 is set (that is SRQ) |
| PAUSE 2000 | Wait 2 seconds |
| goto l_LOOP | |
| [read_event] | |
| | |
| CMUBASE: STAT:OPER:EVENT:SADD? | Eval. which SecAddr causes the Event? --> CMUBASE |
| CMUBASE: STAT:OPER:SYMB? | Eval. which bit (event) causes SRQ --> RFNL |
| CMUBASE: *STB? | |
| CMUBASE: *STB? | |
| goto l_LOOP | |

Tips and Tricks for CMU Programming

The following section is intended to give hints for efficient programming and to point out frequent mistakes that may impair the system performance.

1. Avoid Frequent DLL Swapping

Many CMU function groups use the same commands enabling program parts to be reused in different contexts. As a consequence, commands may be repeated several times within a program that addresses several function groups. The CMU is designed for multi-mode operation, however, changing from one function group to another generally absorbs system capacity for loading new software modules. It is therefore advisable to group the commands so that the number of function group swaps is minimized.

| | | | |
|------------|---------------------------|-------|---------------------------|
| Instead of | GSM900MS_Sig: <Setting_A> | write | GSM900MS_Sig: <Setting_A> |
| | GSM400MS_Sig: <Setting_A> | | GSM900MS_Sig: <Setting_B> |
| | ... | | ... |
| | GSM900MS_Sig: <Setting_B> | | GSM400MS_Sig: <Setting_A> |
| | GSM400MS_Sig: <Setting_B> | | GSM400MS_Sig: <Setting_B> |

Contents

| | |
|---|------------|
| 8 Maintenance and Interfaces | 8.1 |
| Maintenance..... | 8.1 |
| Cleaning the Outside..... | 8.1 |
| Storing and Packing..... | 8.1 |
| Hardware Interfaces | 8.2 |
| GPIB Bus Interface..... | 8.2 |
| Characteristics of the Interface | 8.2 |
| Bus Lines | 8.3 |
| Interface Messages..... | 8.4 |
| Serial Interfaces (COM 1, COM 2)..... | 8.5 |
| Interface characteristics | 8.5 |
| Signal lines..... | 8.6 |
| Transmission Parameters..... | 8.7 |
| Interface functions..... | 8.7 |
| Handshake..... | 8.8 |
| Connectors for Peripherals | 8.10 |
| Printer Connector (LPT)..... | 8.10 |
| Monitor Connector (MONITOR)..... | 8.11 |
| Keyboard Connector (USB) | 8.11 |
| Signal Inputs and Outputs..... | 8.12 |
| RF Connectors..... | 8.12 |
| Inputs and Outputs for the Reference Frequency (REF...) | 8.12 |
| AF Connectors | 8.13 |
| AF Connector SPEECH (Optional) | 8.13 |
| IF Signal..... | 8.13 |
| Service and Auxiliary Connectors | 8.14 |
| Abis Connector (R&S® CMU300 with Option R&S® CMU-B71 only) | 8.16 |
| I/Q CH1 Connector (R&S® CMU200 with Option R&S® CMU-B17 only) | 8.17 |
| IF3 Connectors (R&S® CMU200 with Option R&S® CMU-B17 only) | 8.18 |

8 Maintenance and Interfaces

The following chapter contains information on the maintenance of the R&S® CMU.

Please follow the instructions in the service manual and in the installation instructions provided with the parts when exchanging modules or ordering spare parts. The order no. for spare parts can be found in the service manual.

The address of our support center and a list of all Rohde & Schwarz service centers can be found at the beginning of this manual.

The service manual contains more information on troubleshooting, repair, exchange of modules (including battery exchange, adjustment of the OCXO oscillator) and calibration.

Maintenance

The R&S® CMU does not require any special maintenance. Remove any dust on the instrument by means of a soft cloth. Make sure that the air vents are not obstructed.

Cleaning the Outside

The outside of the instrument is suitably cleaned using a soft, line-free dust cloth.



Caution!

Never use solvents such as thinners, acetone and similar things, as they may damage the front panel labeling or plastic parts.

Storing and Packing

The R&S® CMU can be stored in the temperature range quoted in the data sheet. When stored for an extended period of time the instrument should be protected against dust.

The original packing should be used, particularly the protective covers at the front and rear, when the instrument is transported or dispatched. If the original packing is no longer available, use a sturdy cardboard box of suitable size and carefully wrap the instrument to protect it against mechanical damage.

Hardware Interfaces

The following sections give a description of the instrument's front and rear panel connectors with their technical data.

GPIB Bus Interface

The instrument is equipped with a GPIB bus (IEC/IEEE-bus) connection. The interface connector labeled *IEEE 488 / IEC 625* is located on the rear panel of the instrument. A controller for remote control can be connected via the GPIB bus interface using a shielded cable.

Characteristics of the Interface

- 8-bit parallel data transfer
- Bidirectional data transfer
- Three-line handshake
- High data transfer rate of max. 1 MByte/s
- Up to 15 devices can be connected
- Maximum length of the connecting cables 15 m. The length of a single connecting cable should not exceed 2 m; if many devices are used, it should not exceed 1 m.
- Wired OR if several instruments are connected in parallel

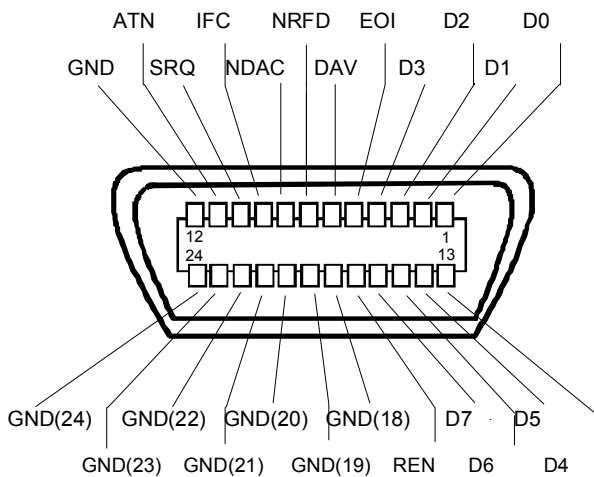

Fig. 8-1 Pin assignment of the GPIB bus interface

Bus Lines

1. Data bus with 8 lines D0 to D7

The transmission is bit-parallel and byte-serial in the ASCII/ISO code. D0 is the least significant bit, D7 the most significant bit.

2. Control bus with 5 lines

IFC (Interface Clear),
active LOW resets the interfaces of the instruments connected to the default setting.

ATN (Attention),
active LOW signals the transmission of interface messages
inactive HIGH signals the transmission of device messages.

SRQ (Service Request),
active LOW enables the connected device to send a service request to the controller.

REN (Remote Enable),
active LOW permits switchover to remote control.

EOI (End or Identify),
has two functions in connection with ATN:
ATN=HIGH active LOW marks the end of data transmission.
ATN=LOW active LOW triggers a parallel poll.

3. Handshake bus with three lines

DAV (Data Valid),
active LOW signals a valid data byte on the data bus.

NRFD (Not Ready For Data),
active LOW signals that one of the connected devices is not ready for data transfer.

NDAC (Not Data Accepted),
active LOW signals that the instrument connected is accepting the data on the data bus.

Interface Messages

Interface messages are transmitted to the instrument on the data lines, with the attention line being active (LOW). They serve to communicate between controller and instrument.

Universal Commands

Universal commands are encoded in the range 10 through 1F hex. They are effective for all instruments connected to the bus without previous addressing.

Table 8-1 Universal Commands

| Command | QuickBASIC command | Effect on the instrument |
|-----------------------|--------------------------------|--|
| DCL (Device Clear) | IBCMD (controller%, CHR\$(20)) | Aborts processing of the commands just received and sets the command processing software to a defined initial state. Does not change the instrument setting. |
| IFC (Interface Clear) | IBSIC (controller%) | Resets the interfaces to the default setting. |
| LLO (Local Lockout) | IBCMD (controller%, CHR\$(17)) | Locks switchover from remote control to <i>Local</i> (manual control) by means of the front panel keys |

Addressed Commands

Addressed commands are encoded in the range 00 through 0F hex. They are only effective for instruments addressed as listeners.

Table 8-2 Addressed Commands

| Command | QuickBASIC command | Effect on the instrument |
|-------------------|--------------------|--|
| GTL (Go to Local) | IBLOC (device%) | Transition to the <i>Local</i> state (manual control). |

Note: *The R&S® CMU can not be configured as a high-speed HS488 listener; the commands CFE (Configure Enable) and CFGn (Configure) are not supported.*

Serial Interfaces (COM 1, COM 2)

The R&S® CMU is equipped with two serial RS-232-C interfaces. The two 9-pin standard Sub-D male connectors are labeled COM 1 and COM 2 and located on the rear panel. A controller for remote control can be connected to this interface.

The two RS-232 interfaces provide two independent channels which can be active simultaneously. The interfaces are activated and configured in the *Setup - Remote* menu or via remote control using the `SYSTEM:COMMunicate:SERial...` commands.

Interface characteristics

- Serial data transmission in asynchronous mode
- Bidirectional data transmission on two separate lines
- Transmission rate selectable from 110 to 115200 baud
- Logical 0 signal from +3 V to +15 V
- Logical 1 signal from -15 V to -3 V
- Hardware handshake RTS/CTS or software handshake XON/XOFF available

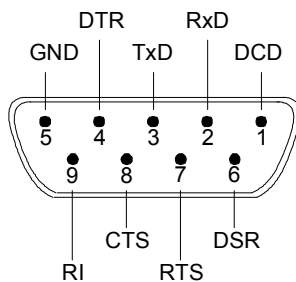

Fig. 8-2 Pin assignment of the RS-232-C interfaces

| Designation | Abbreviation | Pin (9-pin male) | Pin (25-pin male) |
|---------------------|--------------|------------------|-------------------|
| Data Carrier Detect | DCD | 1 | 8 |
| Receive Data | RxD | 2 | 3 |
| Transmit Data | TxD | 3 | 2 |
| Data Terminal Ready | DTR | 4 | 20 |
| Signal Ground | GND | 5 | 7 |
| Data Set Ready | DSR | 6 | 6 |
| Request To Send | RTS | 7 | 4 |
| Clear To Send | CTS | 8 | 5 |
| Ring Indicator | RI | 9 | 22 |

Signal lines

1. Data lines

RxD (Receive Data)
Input data.

Data transfer is bit-serial in the ASCII code, starting with the least significant bit (LSB).

TxD (Transmit Data)
Output data.

Data transfer is bit-serial in the ASCII code, starting with the least significant bit (LSB). The two data lines RxD and TxD are a minimum requirement for data transfer. The following control lines are necessary in addition if a hardware handshake is to be used.

2. Control and message lines

DCD (Data Carrier Detect)
active LOW.

Input; using this signal the data terminal recognizes that the modem of the remote station receives valid data with a sufficient signal level. DCD is used to disable the receiver in the data terminal and prevent reading of false data if the modem cannot interpret the signals of the remote station.

DTR (Data Terminal Ready)
active LOW,

Output; with DTR, the instrument indicates that it is ready to receive data.

DSR (Data Set Ready)
active LOW,

Input; DSR indicates to the instrument that the remote station is ready to receive data.

RTS (Request To Send)
active LOW.

Output; with RTS, the instrument indicates that it is ready to receive data. The RTS line controls whether the instrument is ready to receive data or not.

CTS (Clear To Send)
active LOW.

Input; CTS tells the instrument that the remote station is ready to receive data.

RI (Ring Indicator)
active LOW.

Input; RI is used by a modem to indicate that a remote station wants to set up a connection.

Transmission Parameters

In order to ensure error-free and correct data transmission, the parameters of the instrument and the controller must be set identically. The parameters of the RS-232 interfaces can be set in the *Setup - Remote* menu or using the command group `SYSTEM:COMMunicate:SERial...`

Table 8-3 Transmission parameters of the RS-232 interface

| Parameter | Default | Description / Parameter Range |
|------------|------------------------|---|
| Baud rate | 9600 baud ¹ | The instrument allows baud rates between 110 and 115200 baud to be set, see chapter 4, <i>Setup - Remote</i> menu. |
| Data bits | 8 ² | Data transmission is in the 7- or 8-bit ASCII code, starting with the least significant bit (LSB). |
| Stop bit | 1 ³ | Transmission of a data byte is terminated by one or two stop bits. The sum of data bits and stop bits must be equal to 9. |
| Parity bit | None | A parity bit can be transmitted for error protection. The settings <i>No parity</i> , <i>even</i> or <i>odd</i> parity are allowed. |

Example: Transmission of character 'A' (41 Hex) in 8-bit ASCII code with even parity and one stop bit:

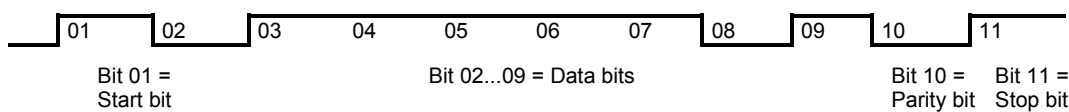

Interface functions

For interface control, some control characters from the ASCII code range of 0 to 20 hex are predefined and can be transmitted via the interface.

Table 8-4 Control strings or control characters of the RS-232-C interface

| Control Character | Function |
|---|--|
| Break (at least 1 character only log 0) | Reset instrument |
| 0Dhex, 0Ahex | Terminator <CR>, <LF> Switchover between local/remote |

¹ The default baud rate is 19200 baud for a COM port that is used as a GPIB connector.

² The default number of data bits is 7 for a COM port that is used for data transfer.

³ The default number of stop bits is 2 for a COM port that is used for data transfer.

Handshake

Software handshake

In case of a software handshake data transfer is controlled using the two control characters XON / XOFF:

- The R&S® CMU uses the control character XON to indicate that it is ready to receive data.
- If the receive buffer is full it sends the XOFF character via the interface to the controller. The controller interrupts data output until it receives another XON from the R&S® CMU.
- In the same way the controller indicates to the R&S® CMU that it is ready to receive data.

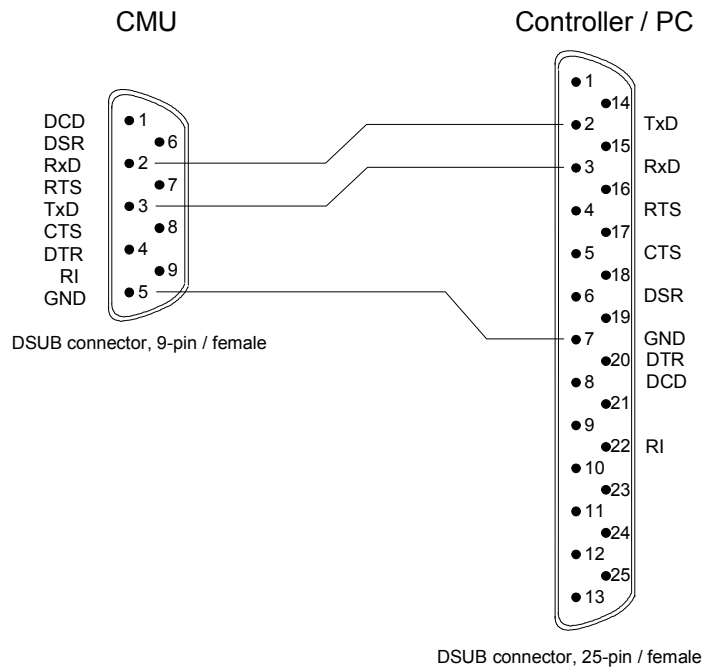
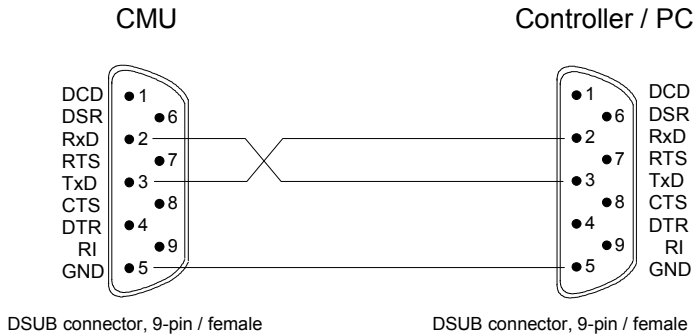

Connection between instrument and controller (Null-modem cable)

The connection of the instrument to a controller is made with a so-called null-modem cable. Here the data, control and signalling lines must be crossed. The wiring diagram on the left applies to a controller with a 9-pin or 25-pin configuration.

Fig. 8-3 Wiring of the data lines for software handshake

Hardware handshake

In case of a hardware handshake, the instrument signals that it is ready for reception via line DTR and RTS. A logic '0' means "ready" and a '1' means "not ready". The RTS line is always active (logical '0'), provided that the serial interface is switched on. The DTR line controls whether the analyzer is ready for reception or not.

The CTS or DSR lines (see signal lines) tell the instrument whether the remote station is ready for reception or not. A logical '0' on both lines switches on data transmission, a logical '1' on both lines stops data transmission of the generator. The TxD line is used for data transfer.

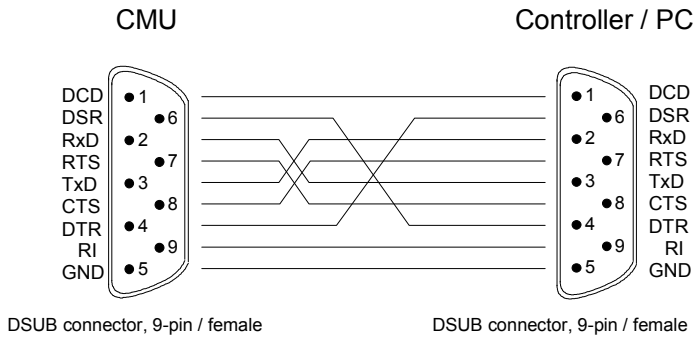

DSUB connector, 9-pin / female

DSUB connector, 9-pin / female

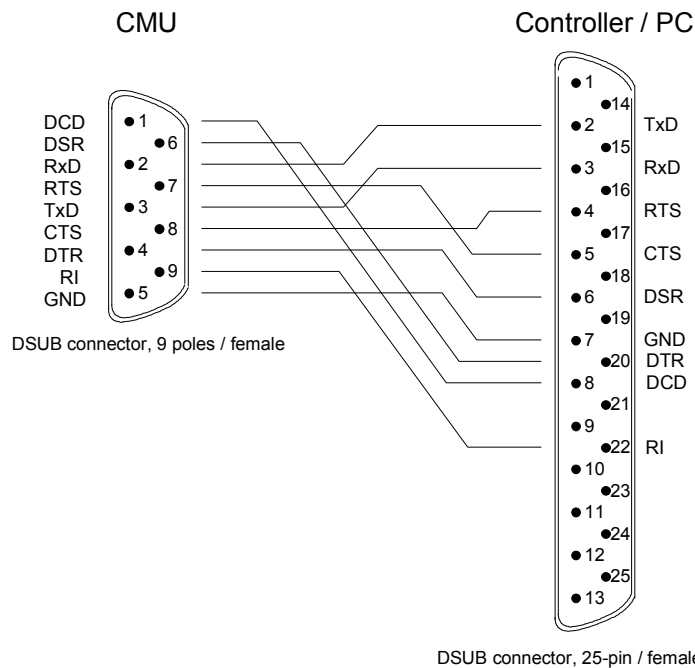

DSUB connector, 9 poles / female

DSUB connector, 25-pin / female

Connection between instrument and controller (Null-modem cable)

The connection of the instrument to a controller is made with a so-called null-modem cable. Here the data, control and signalling lines must be crossed. The wiring diagram on the left applies to a controller with a 9-pin or 25-pin configuration.

Fig. 8-4 Wiring of the data, control and message lines for hardware handshake

Connectors for Peripherals

Printer Connector (LPT)

The 25-pin standard Sub-D female connector LPT on the rear panel of the R&S® CMU is intended for connecting a printer. The interface is CENTRONICS compatible.

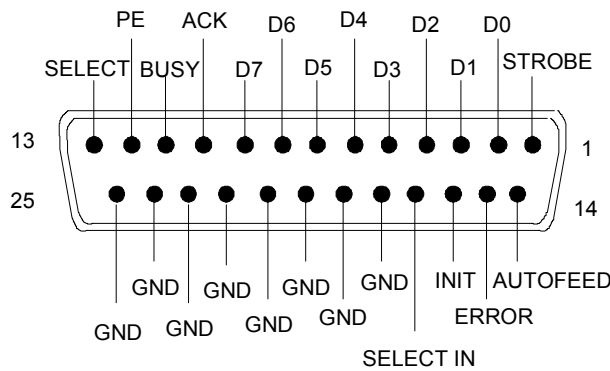
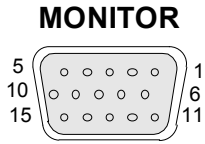

Fig. 8-5 Pin assignment of the LPT connector

| Pin | Signal | Input (I) Output (O) | Description |
|---------|-----------|-------------------------|---|
| 1 | STROBE | O | Impulse for transfer of a data byte, 1µs pulse width at minimum (active LOW) |
| 2 | D0 | O | Data line 0 |
| 3 | D1 | O | Data line 1 |
| 4 | D2 | O | Data line 2 |
| 5 | D3 | O | Data line 3 |
| 6 | D4 | O | Data line 4 |
| 7 | D5 | O | Data line 5 |
| 8 | D6 | O | Data line 6 |
| 9 | D7 | O | Data line 7 |
| 10 | ACK | I | Indicates that the printer is ready to receive the next byte (active LOW) |
| 11 | BUSY | I | Signal active if the printer is unable to receive data |
| 12 | PE | I | The signal is activated if no printer paper is available (active HIGH). |
| 13 | SELECT | I | The signal is activated when the printer is selected (active HIGH). |
| 14 | AUTOFEED | O | If the signal is active the printer inserts a line feed after each line (active LOW). |
| 15 | ERROR | I | The signal is activated if no printer paper is available or an error occurred (active LOW). |
| 16 | INIT | O | Initializing the printer (active LOW) |
| 17 | SELECT IN | O | If the signal is active the codes DC1/DC3 are ignored by the printer (active LOW). |
| 18 - 25 | GND | | Connected to ground |

Monitor Connector (MONITOR)

The 15-pin Sub-D female connector MONITOR at the rear panel of the R&S[®] CMU is intended for connecting an external VGA monitor.



| Pin No. | Signal |
|---------|----------------|
| 1 | RED (output) |
| 2 | GREEN (output) |
| 3 | BLUE (output) |
| 4 | MID2 (NC) |
| 5 | NC |
| 6 | R-GND |
| 7 | G-GND |
| 8 | B-GND |
| 9 | NC |
| 10 | GND |
| 11 | MID0 (NC) |
| 12 | MID1 (NC) |
| 13 | HSYNC (output) |
| 14 | VSYNC (output) |
| 15 | NC |

Fig. 8-6 Pin assignment of the MONITOR connector

Keyboard Connector (USB)

Double Universal Serial Bus connector of type A (master USB), used to connect an external keyboard.

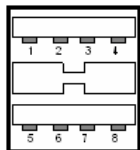

Fig. 8-7 USB connector

Note: *The USB connector is intended for keyboard connection but not for other USB pointing or storage devices.*

Signal Inputs and Outputs

RF Connectors

The N-type connectors on the front panel labeled *RF1*, *RF 2*, *RF 3 OUT* and *RF4 IN* are used as inputs and outputs for RF signals. The maximum permitted input levels are listed in the data sheet.

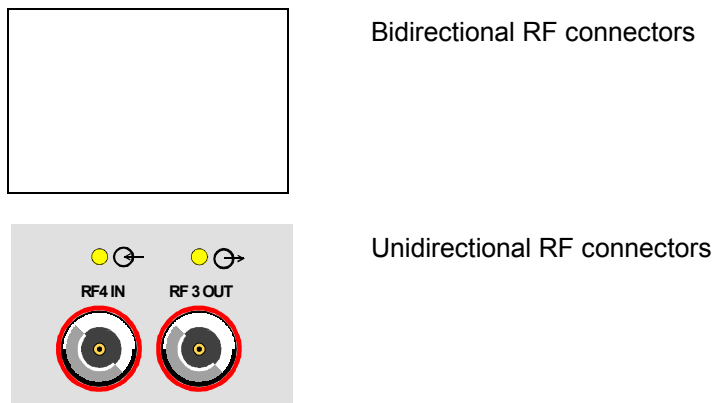
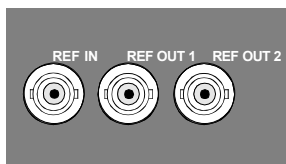

Fig. 8-8 RF connectors

Inputs and Outputs for the Reference Frequency (REF...)

The BNC connectors on the rear panel labeled REF IN, REF OUT 1 and REF OUT2 are used for synchronization of the R&S® CMU with external devices.



- REF IN** This input is used to synchronize the R&S® CMU to other instruments. The frequency of the external reference signal fed in at REF IN must be set in the *Sync.* tab of the *Connection Control* menu or via the `CONFigure:SYNChronize:FREQuency:REFerence` command.
- REF OUT 1** A signal for synchronization of other instruments is available at this output connector. This signal is either the reference frequency of the R&S® CMU or the signal applied to the input REF IN (see *Sync.* tab of the *Connection Control* menu).
- REF OUT 2** A clock signal applied to this output and can be used for synchronizing external devices. The clock frequency can be selected from a list of network-specific frequencies in the *Sync.* tab of the *Connection Control* menu.

Fig. 8-10 Inputs and outputs for reference frequency

AF Connectors

The BNC connectors AF IN, AF OUT, AUX1 and AUX2 on the front panel are used as inputs and outputs for audio signals. The connectors are only used if option R&S® CMU-B41, Audio Generator and Analyzer, is available.

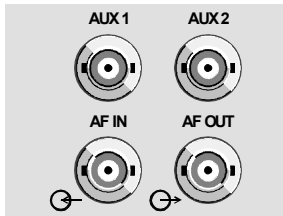

AUX1/2 Input and output for AF signals (secondary audio circuit)

AF IN, AF OUT Input and output for AF signals (primary audio circuit)

The technical specifications of the audio generator and analyzer are listed in the data sheet. The audio signals can be routed to the speech codec; see description of option R&S® CMU-B41 in chapter 4 and description of the *AF/RF Connector* tabs of the *Connection Control* menu in the network test manuals.

AF Connector SPEECH (Optional)

The 9-pin Sub-D female connector *SPEECH* on the front panel of the instrument can be used for connecting a handset to the signalling unit.

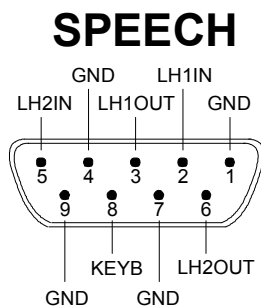

| Pin No. | Signal | Input (I) / Output (O) / Bidirectional (B) | Description |
|---------|----------------|--|-----------------------------------|
| 1 | GND | B | |
| 2 | LH1HAND SETIN | I | AF signals to signalling unit 1 |
| 3 | LH1HAND SETOUT | O | AF signals from signalling unit 1 |
| 4 | GND | B | |
| 5 | LH2HAND SETIN | I | Signals to signalling unit 2 |
| 6 | LH2HAND SETOUT | O | Signals from signalling unit 2 |
| 7 | GND | B | |
| 8 | +5VKEYB | O | Power supply +5.2 V, max. 100 mA |
| 9 | GND | B | |

Fig. 8-13 AF connector SPEECH

IF Signal

One BNC connector providing an IF signal is located on the rear panel of the R&S® CMU.

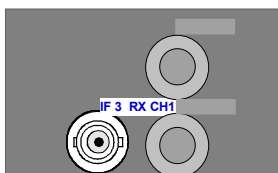

IF3 RX CH1 connector (BNC connector), provides an IF signal from the RXTX board 1 for monitoring purposes.

Fig. 8-14 IF signal output

Service and Auxiliary Connectors

A 9-pin Sub-D female connector *SERVICE* for the modules RXTX Boards is located on the rear panel. This connector is intended for internal tests only and must not be used as a signal input or output.

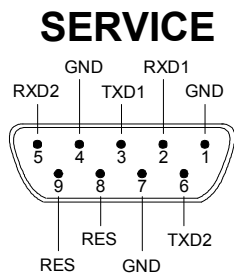
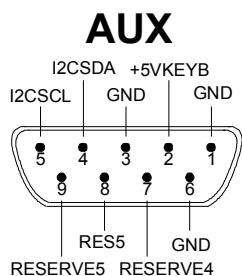

Fig. 8-15 SERVICE connector

A 9-pin SUB-D female connector *AUX* on the rear panel provides a +5.2 V power supply. The pin assignment is as follows:



| Pin | Signal | Input (I) / Output (O) / Bidirectional (B) | Description |
|-----|----------|--|----------------------------------|
| 1 | GND | B | GND |
| 2 | +5VKEYB | O | Power supply +5.2 V, max. 100 mA |
| 3 | GND | B | GND |
| 4 | I2CSDA | B | For future extensions |
| 5 | I2CSCL | O | For future extensions |
| 6 | GND | B | GND |
| 7 | RESERVE4 | B | |
| 8 | RESERVE5 | B | |
| 9 | RESERVE6 | B | |

Fig. 8-16 AUX connector

The 15-pin SUB-D female connector *AUX 3* on the front panel is used as an input or output for status, control, and trigger signals. These signals are applied to particular (in some function groups: selectable) pins of the *AUX 3* connector (refer to the corresponding menu).

The pin assignment of the *AUX 3* connector is as follows:

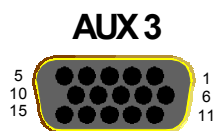

| Pin | Signal | Input (I) / Output (A) / Bidirectional (B) | Description |
|-----|--------|--|---|
| 1 | GND | B | |
| 2 | TBUS1 | O | Timing output A Test signal CH1 GSMxxx-MS Signalling: Frame trigger (see GSMxxx-MS operating manual) Bluetooth Signalling: Signalling trigger (see Bluetooth (CMU-K53) manual) |
| 3 | TBUS2 | O | Timing output B |
| 4 | TBUS3 | O | Timing output C |
| 5 | TBUS4 | O | Timing output D |
| 6 | TBUS5 | I | External trigger input R&S® CMU300: External trigger signal for wired synchronization |
| 7 | TBUS6 | I | External trigger B |
| 8 | TBUS7 | I | External trigger A External trigger signal CH1 input for <i>Spectrum</i> and <i>Power</i> measurements |
| 9 | GND | B | GND |
| 10 | GND | B | GND |
| 11 | GND | B | GND |
| 12 | GND | B | GND |
| 13 | GND | B | GND |
| 14 | GND | B | GND |
| 15 | GND | B | GND |

Fig. 8-17 AUX 3 connector

The 15-pin SUB-D female connector AUX 4 on the rear panel is used as an input or output for status, control, and trigger signals. These signals are applied to definite pins of the AUX 4 connector (refer to the corresponding menu).

The pin assignment of the AUX 4 connector is as follows:

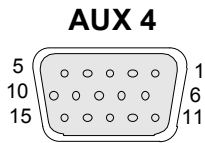

| Pin | Signal | Input (I) / Output (O) / Bidirectional (B) | Description |
|-----|--------|--|-------------------------------|
| 1 | GND | B | GND |
| 2 | GND | B | GND |
| 3 | GND | B | GND |
| 4 | GND | B | GND |
| 5 | GND | B | GND |
| 6 | GND | B | GND |
| 7 | GND | B | GND |
| 8 | GND | B | GND |
| 9 | TBUS8 | B | Status/control/trigger signal |
| 10 | TBUS9 | B | Status/control/trigger signal |
| 11 | TBUS10 | B | Status/control/trigger signal |
| 12 | TBUS11 | B | Status/control/trigger signal |
| 13 | TBUS12 | B | Status/control/trigger signal |
| 14 | TBUS13 | B | Status/control/trigger signal |
| 15 | TBUS14 | B | Status/control/trigger signal |

Fig. 8-18 AUX 4 connector

Abis Connector (R&S® CMU300 with Option R&S® CMU-B71 only)

A 9-pin SUB-D female connector ABIS on the rear panel provides a symmetric (balanced) input of the *Abis Interface Unit for CMU* (option R&S® CMU.B71; for R&S® CMU300 only) The pin assignment is as follows:

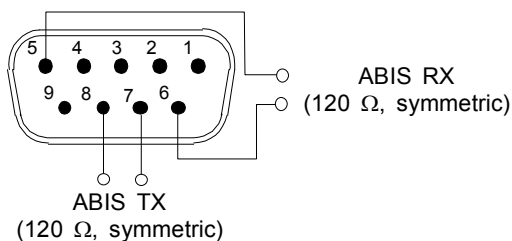

| Pin | Signal | Input (I) / Output (O) / Bidirectional (B) | Description |
|-----|---------|--|-----------------------|
| 1 | – | – | Not connected |
| 2 | – | – | Not connected |
| 3 | – | – | Not connected |
| 4 | – | – | Not connected |
| 5 | ABIS RX | I | Symmetric Abis input |
| 6 | ABIS RX | I | Symmetric Abis input |
| 7 | ABIS TX | O | For future extensions |
| 8 | ABIS TX | O | For future extensions |
| 9 | GND | B | GND |

Fig. 8-19 ABIS connector

I/Q CH1 Connector (R&S® CMU200 with Option R&S® CMU-B17 only)

A 15-pin SUB-D female connector I/Q CH1 provides the inputs and outputs for I/Q signals (option R&S® CMU-B17) The pin assignment is as follows:

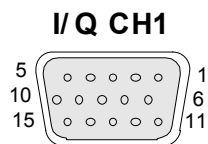

| Pin | Signal | Input (I) / Output (O) / Bidirectional (B) | Description |
|-----|-------------|--|--|
| 1 | GND | – | – |
| 2 | MOD_I_IN | I | I input, TX path, max ±0.5 V, impedance 50 Ohm |
| 3 | MOD_Q_IN | I | Q input, TX path, max ±0.5 V, impedance 50 Ohm |
| 4 | GND | – | – |
| 5 | MOD_I_OUT | O | I output, TX path, max ±0.5 V, impedance 50 Ohm |
| 6 | MOD_Q_OUT | O | Q output, TX path, max ±0.5 V, impedance 50 Ohm |
| 7 | GND | – | – |
| 8 | DEMOD_I_IN | I | I input, RX path, max ±0.5 V, impedance 50 Ohm |
| 9 | DEMOD_Q_IN | I | Q input, RX path, max ±0.5 V, impedance 50 Ohm |
| 10 | GND | – | – |
| 11 | DEMOD_I_OUT | O | I output, RX path, max ±0.5 V, impedance 50 Ohm |
| 12 | DEMOD_Q_OUT | O | Q output, RX path, max ±0.5 V, impedance 50 Ohm |
| 13 | GND | – | – |
| 14 | – | – | – |
| 15 | – | – | – |

Fig. 8-20 I/Q CH1 connector

IF3 Connectors (R&S® CMU200 with Option R&S® CMU-B17 only)

Four BNC connectors provide the inputs and outputs for IF signals (option R&S® CMU-B17) The BNC shield of all these connectors is connected to GND. The remaining specifications are as follows:

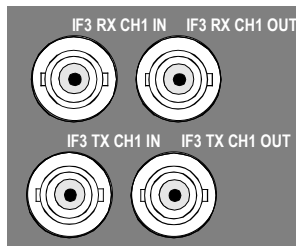

| Connector | Function |
|----------------|---|
| IF3 RX CH1 IN | IF input, RX path, f= 7,68 MHz or 10,7 MHz; max level +2 dBm PEP; impedance 50 Ohm |
| IF3 RX CH1 OUT | IF output, RX path, f= 7,68 MHz or 10,7 MHz; max level +4 dBm PEP; impedance 50 Ohm |
| IF3 TX CH1 IN | IF input, TX path, f= 15,36 MHz or 13,85 MHz; max level +3 dBm PEP for WCDMA, max level -5 dBm for GSM; impedance 50 Ohm |
| IF3 TX CH1 OUT | IF output, TX path, f= 15,36 MHz or 13,85 MHz; max level +3 dBm PEP for WCDMA, max level -5 dBm for GSM; impedance 50 Ohm |

Fig. 8-21 IF3 connectors

Contents

| | |
|---|------------|
| 9 Error Messages | 9.1 |
| SCPI Error Messages | 9.1 |
| No error | 9.1 |
| Command error | 9.1 |
| Execution error | 9.3 |
| Device-specific error | 9.5 |
| Query error - error upon data request | 9.6 |

9 Error Messages

In case of an error during operation, the R&S® CMU displays a yellow notice box with a message describing the error and one or several buttons to close the box and continue operation. Accordingly, the instrument can generate error messages while executing a remote control program. Many error messages are defined in the SCPI standard. They are the same in all SCPI instruments and not related to a particular function group.

SCPI Error Messages

SCPI error messages are assigned negative numbers. The standard text of the error message is often supplemented by a comment from the R&S® CMU, which provides more detailed information (device-dependent information). Since this part depends on the individual situation, it often contains more relevant information than the standard text.

No error

| Error code | Explanation |
|------------|---|
| 0 | No error This message is output when there are no entries in the error queue. |

Command error

The following errors cause bit 5 in the ESR register to be set.

| Error code | Explanation |
|------------|--|
| -100 | Command error Generic error message that cannot detect a more specific error. |
| -101 | Invalid character The command contains a character which is invalid for that type. |
| -102 | Syntax error The data type received is not accepted at this position. |
| -103 | Invalid separator The semicolon was omitted after a program message unit. |
| -104 | Data type error The recognized data element is of the wrong type (e.g. character data instead of numeric data) |
| -105 | GET not allowed |

| Error code | Explanation |
|------------|---|
| | A GET was received within a program message. |
| -108 | Parameter not allowed The command contains parameters at a position where they are not accepted. |
| -109 | Missing parameter The command does not contain the required parameters. |
| -111 | Header separator error A character which is not a legal header separator was encountered while parsing the header; for example, no white space followed the header. |
| -112 | Program mnemonic too long The header contains more than 12 characters. |
| -113 | Undefined header The sent command header has not been defined. |
| -114 | Header suffix out of range The command contains an illegal numeric suffix. |
| -120 | Numeric data error An invalid character for the data type being parsed was encountered. |
| -121 | Invalid character in number The command contains an illegal numeric suffix. |
| -123 | Exponent too large The magnitude of the exponent is too large. |
| -124 | Too many digits The decimal numeric data element contains too many digits. |
| -128 | Numeric data not allowed The command contains a numeric data element the device does not accept in this position. |
| -131 | Invalid suffix The suffix is not appropriate for this command. |
| -134 | Suffix too long The suffix contains more than 12 characters. |
| -138 | Suffix not allowed A suffix is not allowed for this command or at this point of the command. |
| -141 | Invalid character data The character data element contains an invalid character or the element is not valid for this command. |
| -144 | Character data too long The character data element contains more than 12 characters. |

| Error code | Explanation |
|------------|---|
| -148 | Character data not allowed The character data is prohibited for this command or at this point of the command. |
| -151 | Invalid string data A string data element was expected, but was invalid for some reason. |
| -158 | String data not allowed The command contains a legal string data element which is not allowed at this point. |
| -161 | Invalid block data The command contains illegal block data, e.g. no numeric data element is sent after the introductory #. |
| -168 | Block data not allowed The command contains legal block data which are not allowed at this point. |
| -171 | Invalid expression The expression data element was invalid; for example, unmatched parentheses or an illegal character. |
| -178 | Expression data not allowed A legal expression data was encountered but was not allowed by the device at this point in parsing. |
| -180 | Macro error An error occurred when defining a macro or executing a macro. |

Execution error

The following errors cause bit 4 in the ESR register to be set.

| Error code | Explanation |
|------------|---|
| -200 | Execution error An execution error as defined in IEEE 488.2, has occurred. |
| -203 | Command protected |
| -211 | Trigger ignored A triggering signal was received and recognized by the device but was ignored because of timing considerations. |
| -212 | Arm ignored An arming signal was received and recognized by the device but was ignored. |
| -213 | Init ignored A request for a measurement initiation was ignored as another measurement was already in progress. |
| -221 | Settings conflict A setting contradicts another setting. The last attempted setting was not executed. |

| Error code | Explanation |
|------------|---|
| -222 | Data out of range A value of the transmitted command was outside the legal range. |
| -223 | Too much data More data were sent by the host than the R&S [®] CMU can handle. |
| -224 | Illegal parameter value An exact value, from a list of possible values, was expected but not received. |
| -225 | Out of memory The R&S [®] CMU software has insufficient memory to perform the requested operation. |
| -230 | Data corrupt or stale Possibly invalid data; new reading started but not completed since last access. |
| -240 | Hardware error A legal program command or a query could not be executed because of a hardware problem in the device. |
| -241 | Hardware missing A legal program command or a query could not be executed because of a missing device hardware. |
| -250 | Mass storage error A mass storage error occurred. |
| -251 | Missing mass storage A legal program command or a query could not be executed because of missing mass storage. |
| -252 | Missing media A legal program command or a query could not be executed because of missing media; for example, no floppy disk. |
| -253 | Corrupt media A legal program command or a query could not be executed because of corrupt media; for example, bad floppy disk or wrong format. |
| -254 | Media full A legal program command or a query could not be executed because of the media was full; for example, no room on the floppy disk. |
| -255 | Directory full The specified directory is full – no more files can be written. |
| -256 | File name not found A file with the specified name does not exist. |
| -257 | File name error The specified file name cannot be used, e.g. because the file does not exist (reading, clearing) or already exists (writing, generation). |
| -258 | Media protected A legal program command or a query could not be executed because the media was protected. |

Device-specific error

The following errors cause bit 3 in the ESR register to be set.

| Error code | Explanation |
|------------|---|
| -300 | Device-specific error |
| -310 | System error An unspecified system error has occurred. |
| -311 | Memory error An error was detected in the device's memory. |
| -313 | Calibration memory lost Nonvolatile calibration data have been lost. |
| -314 | Save/recall memory lost Nonvolatile saved data have been lost. |
| -315 | Configuration memory lost Nonvolatile configuration data saved by the device have been lost. |
| -330 | Self-test failed An error occurred during the internal self test. |
| -350 | Queue overflow Error code entered in the queue in lieu of the code when the queue is full. It indicates that an error occurred but was not recorded in the queue. The original error message is lost. |
| -360 | Communication error An unspecified communication error was detected. |
| -361 | Parity error in program message Parity bit was not correct when data were received on a serial port. |
| -362 | Framing error in program message No stop bit was detected when data were received on a serial port. |
| -363 | Input buffer overrun Software or hardware input buffer on serial port overflows with data caused by improper or nonexistent pacing. |

Query error - error upon data request

When the following error codes are output, bit 2 is set in the ESR register.

| Error code | Explanation |
|------------|--|
| -400 | Query error |
| -410 | Query INTERRUPTED The query was interrupted. Example: a query is followed by new data before a response was completely sent. |
| -420 | Query UNTERMINATED An incomplete query was received. Example: the device is addressed to talk although the received query was incomplete. |
| -430 | Query DEADLOCKED A condition causing a DEADLOCKED query error occurred. Example: both input and output buffer are full and the device can not continue. |
| -440 | Query UNTERMINATED after indefinite response A query was received in the same program message after a query requesting an indefinite response was execute. |

Index

3

3-dB bandwidth 4.49, 4.56

A

Abs. 1/2 4.49, 4.61
 AC Coupling 6.126, 6.144
 AC supply connection 1.13
 Accept 4.80
 Activate other software 1.29
 Additional RF Generator 4.77
 Address
 GPIB bus 5.2
 primary/secondary 5.2
 Addressed commands 8.4
 AF analyzer (control)
 Audio 4.97
 remote control 6.109
 AF Chan. One 4.108
 AF Chan. One (Multitone) 4.108
 AF Chan. Two (Multitone) 4.108
 AF Connector Overview, Non Signalling 4.101
 AF Frequency 4.78, 6.47
 AF Generator Lead 4.113
 remote control 6.119, 6.131
 AF IN, AF OUT (connectors) 8.13
 AF Max. Level 4.98, 6.108
 Multitone 4.109
 AF Mode, AF max. Level 4.109
 AF Mode (input level) 4.99
 AF Path Coupling 4.113, 6.111, 6.118, 6.130
 AF Ref. Level 4.113, 6.118, 6.130
 AF Voltage 4.100
 Alphanumerical characters 3.12
 Amplitude modulation 4.78, 4.130, 4.132
 Analyzer
 Audio 4.97
 remote control (Audio) 6.109
 RF 4.73
 Analyzer 1 4.98
 Analyzer 2 4.98
 Analyzer Configuration (Audio) 4.97, 4.102
 remote control 6.111
 Analyzer Level
 Analyzer/Generator 4.44
 Audio 4.98
 Power 4.49, 4.50, 4.109
 remote control (Audio) 6.108
 Spectrum 4.49, 4.58
 Analyzer Power 3.6, 4.44
 remote control (RF) 6.43
 Analyzer Settings
 Power 4.44, 4.49, 4.50
 Spectrum 4.49, 4.58
 Analyzer/Generator
 Audio 4.96
 RF 4.41
 Analyzer/Generator Configuration 4.46
 Application 3.18, 4.15, 5.28, 6.16
 Audio 4.98
 Power (NS) 4.44
 Application/Destination 4.33, 4.34
 Arrays (measurement results) 5.38
 Attenuation 6.40
 frequency-dependent 4.87

 output level 4.85
 Audio 4.96
 remote control 6.107
 Audio Deviation 4.130, 4.132, 6.47, 6.48
 Audio Frequency 4.130, 4.132, 6.47, 6.48
 Audio Generator and Analyzer 4.93, 4.94, 4.124, 6.107
 Audio Mapping 4.130, 4.132, 6.47, 6.49
 Audio results 4.100
 Auto-increment function 4.6, 4.10
 Autoranging 4.73, 4.74
 Aux Tx 4.77
 AUX1, AUX2 (connectors) 8.13
 Average 4.49, 4.55, 4.65
 Average values (calculation) 3.19

B

Back to previous screen 1.30
 Band pass 4.117, 4.122, 6.125, 6.136, 6.144
 fixed (Audio) 6.112
 variable (Audio) 6.112
 Bandpass (fixed) 4.106
 Bandpass (variable) 4.106
 Bandwidth
 fixed band pass 4.106
 RF analyzer 4.47, 6.43
 variable band pass 4.106, 6.112
 Bandwidth (AC Coup.) 6.113
 Bandwidth (DC Coup.) 6.114
 Baud Rate 4.15
 Baud rate (RS-232) 6.16, 8.7
 Beeper 4.20
 Block Data Format 6.15
 Bluetooth (Audio) 4.99
 Boolean parameter 5.11
 Braces 6.2
 Buffer Writing 4.33, 4.34
 Byte Order 6.15

C

Cancel 4.80
 Capture length, I/Q Recorder 6.82, 6.85
 Capture timeout, I/Q Recorder 6.82, 6.85
 Capture Timeout 6.99, 6.102
 CCITT weighting filter 4.117, 4.122
 Center 4.49, 4.59, 6.59, 6.71
 Chan./Freq. 4.49, 4.53
 Change Dest.
 Logging 4.33, 4.35
 Save 4.31
 Character data 5.10
 Characters 3.12
 Cleaning the outside 8.1
 Clock frequency 4.89, 6.59
 C-message weighted filter 4.117, 4.122
 CMU Hostname (dynamic IP addr.) 6.20, 6.23
 CMU-B21, IP address 4.21, 4.22
 CMU-B41 (Option) 4.93, 4.94, 4.124, 6.107
 CMU-B95 4.77
 CMU-B96 4.77
 CMU-K14 (option) 4.130
 Cnt to R 4.49, 4.61
 COM 1 4.15
 Command
 addressed 8.4

common 6.4
 description 6.1
 generator 5.35
 generator status 5.36
 line structure 5.10
 measurement control 5.29
 measurement status 5.34
 parameters 5.11
 processing 5.13
 recognition 5.14
 sequence 5.15
 structure 5.8
 synchronization 5.15
 syntax elements 5.12
 universal 8.4
 Command Button (Remote Service Tool) 1.28
 Comment 4.6
 Common Command 5.8, 6.4
 Communicate (Setup), remote control 6.16
 Condition register 5.17
 Configuration 3.16
 firmware 1.29
 measurement 3.16
 Configuration file 4.29
 Configuration tree 4.4
 Configure Command Buttons 1.28
 Connection
 controller 1.16, 1.21, 1.26
 external keyboard 1.18
 IEC bus 1.17
 monitor 1.18
 RS-232 1.17
 Connection Control 3.6, 3.16
 remote control (RF) 6.40
 RF 4.73
 Content/Destination 4.31
 Continuous 4.47, 5.36
 Control lines (GPIB bus) 8.3
 Controller connection 1.16
 Controls 3.1
 Copy 4.40
 Copy File 6.31
 Copy non volatile ram to disk 1.37
 Counting 5.36
 Current 4.49, 4.55, 4.65

D

Data 4.29
 bits (RS-232) 8.7
 lines (GPIB bus) 8.3
 set 5.14
 Data Bits 4.15, 6.16
 Date 4.19, 6.19
 DC Coupling 6.125, 6.136, 6.144
 DC Voltage 4.101
 DCL 5.13
 Decimal point 5.11
 Default 4.2
 Default gateway
 CMU-B83 4.21, 4.23
 CMU-B21 4.21, 4.22
 Default Scale 4.110
 Default Settings 4.46
 Defragment disk 1.37
 Delay 6.59, 6.65
 Delete (Data) 4.39
 Delete non volatile ram 1.37
 Delete software 1.30
 Delimiter 5.13
 Delta marker 4.49, 4.51

Delta Marker 6.59, 6.74
 Demo Pack 4.18
 Destination 4.5
 Detect Mode 4.49, 4.66
 Device model 5.13
 Device-specific commands 5.8
 DHCP 4.21, 4.22
 Dialog box 3.10
 Dir. View/Content 4.38
 Display (Multitone) 4.109
 Display Filter 5.4
 Display Format 6.99, 6.103
 Display line 4.49, 4.60, See D-line, See D-line
 Display mode 3.19
 Display Mode
 Power (NS) 4.49, 4.55
 Spectrum 4.49, 4.65
 Display Settings 4.20
 Display/Marker (Power) 4.49, 4.52
 Display/Marker (Power, NS) 4.49, 4.61
 Distortion Frequency 4.103
 D-line
 Power 4.49, 4.51
 Spectrum 4.49, 4.61
 DLL Swapping 7.7
 Domain Name Server (dynamic) 6.20, 6.23
 DSB 4.130, 4.132
 Dwell Time 4.82, 4.83
 Dynamic range 4.73, 4.75

E

Edit service tables 1.36
 Editor 3.10
 Elapsed Time 4.18
 EMC 1.15
 Enable options 4.17
 Enable register 5.17
 EOI (command line) 5.10
 Error messages 9.1
 VersionManager 1.38
 Error queue 5.26
 ESE (event status enable register) 5.21
 Event reporting system 5.32
 Event status enable register (ESE) 5.21
 Exit 1.37
 Exit Assign 4.8
 Expanding table 3.8
 Exponent 5.11
 Ext. Att. Input 4.86, 6.57
 Ext. Att. Output 4.85, 6.57, 6.58
 Ext. Trigger (AUX 3/4) 4.93, 6.41, 6.42
 External attenuation
 frequency-dependent 4.87
 remote control (RF) 6.57
 External keyboard 1.18
 External trigger 4.92

F

Failure Code (dynamic IP addr.) 4.21, 4.23, 6.20, 6.23
 FETCh command 5.39
 FETCh status 5.34
 File Manager 4.29
 File transfer, Remote Service Tool 1.23
 Filename 4.6
 Filename Default 4.10
 Filter
 AF Analyzer 6.112
 I/Q Recorder 6.82, 6.84
 Multitone 4.117, 4.122

Multitone..... 6.125, 6.136
 THD..... 6.143
 Firmware configuration 1.29
 Firmware update 1.20
 Firmware update after board change..... 1.36
 First AF channel..... 6.117, 6.140
 Fixed band pass..... 4.106, 6.112
 FM Deviation..... 4.78, 4.79, 6.47, 6.48
 FM Frequency..... 4.78, 4.79, 6.47, 6.48
 FM Stereo Transmitter 4.130, 4.132
 Format, I/Q Recorder 6.82, 6.86
 Free run trigger mode..... 4.92
 Freq. 4.49, 4.55
 Frequency..... 4.49, 4.66
 AF generator 4.104
 Aux Tx generator..... 4.80, 6.47, 6.53
 Power..... 6.59, 6.64
 reference (Audio)..... 6.111
 remote control (Power)..... 6.59, 6.64, 6.81
 remote control (Spectrum)..... 6.59, 6.71
 RF analyzer..... 4.46, 6.43
 RF generator..... 4.80, 4.81, 6.46
 variable band pass 4.106, 6.112
 Frequency d1 4.121
 Frequency Estimation Limit 6.99, 6.102
 Frequency Hopping 4.81, 6.47, 6.49
 Frequency modulation..... 4.78, 4.130, 4.132
 Frequency Offset, RF generator..... 6.46
 Frequency-dependent attenuation..... 6.34
 Frequency-dependent external attenuation 4.87
 Front view 1.1
 Full Span..... 4.49, 4.59
 Function group 4.7
 Fuses..... 1.13

G

Gain 4.85
 Gap
 Minimum Gap (trigger)..... 6.41, 6.42
 Gateway..... 6.20, 6.24
 static..... 6.20, 6.21, 6.22
 Generator
 Analyzer/Generator 4.45, 4.49, 4.50, 4.60
 Audio..... 4.99, 6.115
 List mode..... 6.47, 6.53
 List mode dwell time..... 6.47, 6.54
 RF..... 4.76
 Generator 1 Frequency 6.116
 Generator 1 Level..... 6.116
 Generator 1 Signal 6.116
 Generator command..... 5.35
 Generator control 5.35, 6.47, 6.54
 remote control (RF) 6.46
 Generator Control..... 4.79
 Generator Level 4.109
 remote control (RF) 6.46
 Generator Level (THD)..... 4.121
 Generator Listmode..... 4.82
 End of list 6.47, 6.54
 Frequency 6.47, 6.55
 Power Level 6.47, 6.55
 steps 6.47, 6.54
 Generator state 5.35
 Generator status 5.36
 GET (Group Execute Trigger) 5.14
 Getting Started..... 2.1
 GPIB bus
 address 5.2
 interface 1.16, 8.2
 Graphical measurement menu 3.7

Grid
 Multitone 4.112, 6.118
 Power 4.49, 4.56, 6.59, 6.63
 Spectrum 4.49, 4.66, 6.59, 6.71
 GSM 4.96

H

Handshake (RS-232) 8.8
 Hardware Equipment 4.18, 4.25
 Hardware Options..... 4.18
 Harmonic distortion..... 4.101
 Harmonics 4.121
 Header..... 3.5, 4.10
 commands 5.8
 Help..... 4.3
 Hopping 4.81, 6.47, 6.49
 Hopping Frequency 6.47, 6.49
 Hopping Mode 6.47, 6.49
 Hotkey 3.3
 Hotkey Assign. 4.8
 Hotkeys Set 1 4.8

I

I/Q Recorder..... 6.82
 I/Q Spectrum 7.3
 I/Q-IF..... 4.93, 4.95, 6.59, 6.60
 path settings 4.93, 4.94
 I/Q-IF Interface
 remote control..... 6.59
 IEC/IEEE bus see GPIB bus
 IF bandwidth, I/Q Recorder..... 6.82, 6.85
 IF Power..... 6.41, 6.42
 IF Power (trigger)..... 4.93
 Info 1.37, 4.25, 6.17, 6.37
 Input buffer 5.13
 Input field..... 3.10
 Input level 1.15
 remote control (RF)..... 6.40
 Inputs/outputs
 remote control (RF)..... 6.57
 RF..... 4.84
 Insert mode..... 3.11
 Install software 1.31
 Instrument functions 4.1
 Interface
 functions (RS-232-C) 8.7
 GPIB bus 8.2
 messages (GPIB bus)..... 5.7, 8.4
 RS-232-C..... 8.5
 Intermodulation..... 4.73, 4.75
 Interrupt..... 5.20
 INV 6.2
 IP address
 dynamic..... 6.20, 6.24
 static..... 6.20, 6.22
 IP Address
 CMU-B21 4.21, 4.22
 CMU-B83..... 4.21, 4.23
 IQSLot, remote control (RF)..... 6.99
 IVAL 5.38

K

Key..... 3.2
 Key Beep..... 4.20, 6.19
 Key words (commands) 5.8
 Keyboard..... 4.20, 6.19
 Keypad 3.11

L

Last Span 4.49, 4.59
 Layer 3 message log 4.33
 Level
 AF generator 4.104
 Generator 4.79
 RF Generator 6.46
 Level (trigger) 6.41
 Non Signalling 4.93
 Level correction 1.39
 Level Handling 4.116
 Level Scale 4.49, 4.52, 4.62, 4.109
 Level Selection 4.116, 6.124, 6.135
 Limit
 check 5.37
 specify 5.37
 Limit lines (Multitone) 4.114
 Limit Lines (Multitone) 6.121, 6.132
 Limit Matching (Multitone) 4.111, 6.128, 6.139
 List all versions to disk 1.37
 List of Commands
 alphabetical 6.171
 by function 6.151
 description 6.3
 List of scalar results 5.38
 List software 1.36
 Literal 6.2
 LLO 5.5
 Local 5.4
 Local Lockout 5.5
 Local to remote 4.12, 6.25
 Local to remote switchover 5.2, 6.25
 Log file, Remote Service Tool 1.28
 Logging 4.33
 Long form (commands) 5.9
 Low distortion 4.73, 4.75
 Low noise 4.73, 4.75
 Low Spur Mode 4.81, 6.47, 6.50
 Lower Limit Line
 Multitone 4.115
 Multitone 6.122
 Multitone 6.133
 Lower-case (commands) 5.9
 LPT interface 8.10

M

Main power switch 2.4, 2.12
 Maintenance 4.26, 8.1
 Make Directory 4.40, 6.30
 Mantissa 5.11
 Manual Level, RF max. Level 4.73, 4.74, 6.40
 Manual operation 3.1
 Marker 4.49, 4.51, 4.60
 Marker values 4.49, 4.53
 Marker/Display, Spectrum 4.49, 4.60
 Marker/Display (Power) 4.49, 4.51
 Max. Level, RF 6.40
 Maximum 4.49, 4.55, 4.65
 Maximum value (commands) 5.11
 Measurement 4.7
 Measurement control 3.16, 5.28
 command 5.29
 diagrams 5.41
 Measurement curve, Power 4.49, 4.54
 Measurement group 3.17
 Measurement Length 6.99, 6.102
 Measurement menu 3.5
 Measurement object 6.1
 Measurement queue 5.33

 remote control 6.25
 Measurement result 5.38
 Measurement state 5.29
 Measurement status 5.34
 Menu
 graphical measurement 3.7
 measurement 3.5
 popup 3.8
 Menu groups 3.16
 Menu Select 4.7
 Menu table 3.8
 Menus
 Multitone 4.110
 Power 4.49, 4.52
 Spectrum 4.49, 4.62
 Messages (GPIB bus) 5.7
 Minimum 4.49, 4.55, 4.65
 Minimum value (commands) 5.10
 Misc. (Setup) 4.20
 remote control 6.19
 Mode
 AF max. Level 6.108
 RF max. level 6.40
 Modulation 6.47
 RF generator 4.78
 Modulation Filter 4.78, 4.79
 Modulation Index 4.78, 4.79, 6.47
 Monitor 1.18
 MONITOR ANALOG 8.11
 Multitone 4.107
 remote control 6.117
 Multitone (control) 4.108, 4.111, 4.112, 4.118, 4.123
 remote control 6.119, 6.130
 Multitone Configuration 4.112
 remote control 6.119, 6.130

N

NAN 5.11
 Narrow-band power, remote control 6.79
 New Line (command line) 5.10
 NINF 5.11
 Non Signalling 3.16, 4.7
 Non volatile ram 1.37, 6.8
 Notation in command tables 6.1
 Notify message (VersionManager) 1.38
 NTRansition register 5.17
 Null-modem 1.17
 Number of Steps 6.99, 6.101
 Number of Subsweeps 6.99, 6.101
 Numeric suffix 6.2
 Numerical input 3.10
 Numerical values 5.11

O

OK to Recall 4.33
 OK to Save 4.32
 Operating concept 3.1
 Operating menu 3.5
 Operating mode 3.5
 Option R&S CMU-K14 4.130
 Option CMU-B41 4.93, 4.94, 4.124
 Option Enable 4.17, 6.18
 Options 4.17, 6.17, 6.18
 Options (Setup) 4.16
 remote control 6.17, 6.37
 Overlapping execution 5.14
 Overrange Level (AuxTx) 4.86
 Overview
 status register 5.18

syntax elements 5.12
 Overwrite mode 3.11
 Ovr. Lev. AuxTx 4.86

P

Packing 8.1
 Page Settings 4.9
 Parallel poll 5.25
 Parallel poll enable register (PPE) 5.21
 Parameter 6.2
 Parameter (commands) 5.11
 Parameter line
 Power 4.49, 4.53
 Spectrum 4.49, 4.63
 Parity 4.15
 Parity (RS-232) 6.17, 8.7
 Partial recall 4.33
 Partial reset 4.3, 6.26, 6.38
 Paste 4.40
 Path (commands) 5.8
 Path Configuration
 Multitone 4.117
 THD 4.122
 Path Coupling 4.103
 Path Coupling (AF IN) 6.143
 Path Selection (AuxTx) 4.80, 6.47, 6.51
 PAVG 5.39
 PC-card selection dialog 1.31
 Peak Search 6.59, 6.74
 Pilot Deviation 4.130, 4.132, 6.47, 6.48
 Pilot Frequency 4.130, 4.132, 6.47, 6.48
 Pow. Meter Freq. Sel. 4.44
 Pow. Meter Wideband 4.86, 4.87, 6.59, 6.77
 Power
 Overview of measurements 4.41
 remote control (RF) 6.59, 6.62
 RF 4.49
 Power (control)
 remote control (RF) 6.43, 6.59, 6.62
 RF 4.49, 4.54
 Power (wideband), remote control 6.59, 6.77, 6.79
 Power Configuration 4.49, 4.54
 Power fuses 1.13
 Power switch 1.13
 Power vs Time (softkey) 4.49, 4.50
 PPE (Parallel poll enable register) 5.21
 Primary Address 4.11, 6.13, 6.16
 remote control 5.2
 Primary audio circuit 6.107
 Print 4.5
 Print Mode 4.5
 Printer (table section) 4.9
 Printer connector 8.10
 Program examples 7.1
 Protocol 4.15, 6.17
 PTRansition register 5.17
 Pull-down list 3.15
 Putting into Operation 1.1, 1.11
 AC supply connection 1.13
 EMC 1.15
 instrument setup 1.11
 mounting in a rack 1.12
 switching on 1.13

Q

Query 5.7
 responses 5.10

R

R to Pk 4.49, 4.61
 Rack mounting 1.12
 RAM 1.37
 Ramping 4.81, 6.47, 6.50
 Range
 Power 6.59, 6.64
 Spectrum 6.59, 6.72
 RBW
 NPOWER 6.81
 Power 4.49, 4.56, 6.59, 6.64
 Spectrum 4.49, 4.59, 4.66, 6.59, 6.72
 READ command 5.41
 Rear view 1.8
 Recall 4.32
 all 6.33
 current 6.33, 6.38
 Re-edit 4.80
 REF OUT 2 4.90, 4.91, 6.59
 Ref. R
 Power 4.49, 4.51
 Spectrum 4.49, 4.60
 Ref. to R 4.49, 4.61
 Reference 6.40, 6.41
 Reference Frequency 4.89, 6.33
 connectors 8.12
 remote control (NS) 6.59
 Reference Frequency Not Locked 4.90, 5.22, 6.34
 Reference Level 4.49, 4.58
 Reference marker
 Power 4.49, 4.51
 Spectrum 4.49, 4.61
 Reference Marker 6.59, 6.74
 Rel. 1, Spectrum 4.49, 4.61
 Rel. 1Power 4.49, 4.51
 Rel. 2, Spectrum 4.49, 4.61
 Rel. 2Power 4.49, 4.51
 Remote (Setup) 4.11
 remote control 6.13
 Remote control
 basics 5.1
 program examples 7.1
 quit 5.5
 Remote Service Tool 1.24, 1.27
 switchover 5.2
 Remote Debug Mode 4.13, 4.14, 6.15
 Remote Service Tool 1.20
 Rename 4.38
 Repetition 4.47, 4.49, 4.54
 Audio 6.111
 IQSlot 6.99, 6.101
 Multitone 6.119, 6.130
 Power 6.59, 6.63
 RF analyzer 6.44
 Spectrum 6.59, 6.71
 THD 6.142, 6.147
 Repetition mode 3.18
 Report, Maintenance 4.29
 Report Display 4.13, 5.4
 Report File 4.13, 5.4
 Report Mode 6.27
 Reset 4.3, 6.26
 status reporting system 5.27
 Resolution bandwidth
 remote control (RF) 6.59, 6.64, 6.81
 RF analyzer 4.47
 Responses to queries 5.10
 Result 4.114, 5.38
 Audio 4.100
 IQRecorder 6.82, 6.88, 6.94

| | |
|---|------------------------|
| Multitone..... | 6.119, 6.131 |
| Result (Audio Analyzer/Generator)..... | 4.96 |
| remote control..... | 6.115 |
| Result (IQSLot), remote control (RF)..... | 6.99, 6.104 |
| Result (Multitone)..... | 4.110 |
| remote control..... | 6.127, 6.138 |
| Result (Power) | |
| remote control (RF)..... | 6.59, 6.67 |
| RF..... | 4.49, 4.53 |
| Result (Spectrum) | |
| remote control (RF)..... | 6.59, 6.75 |
| RF..... | 4.49, 4.63 |
| Result (THD) | |
| remote control..... | 6.145, 6.148 |
| RF Attenuation, input level..... | 4.73, 4.75 |
| RF Connectors..... | 8.12 |
| RF generator, control..... | 4.79 |
| RF Input..... | 6.57 |
| RF Level, AUX Tx Generator..... | 6.47, 6.52 |
| RF Max. Level..... | 4.73, 4.74 |
| RF measurements | |
| manual control..... | 4.41 |
| remote control (RF)..... | 6.40 |
| RF Mode, RF Max. Level..... | 4.73, 4.74 |
| RF Output..... | 6.57, 6.58 |
| RF Power (trigger)..... | 4.93 |
| RF Tx Output..... | 4.84, 4.85 |
| RF user correction..... | 1.39 |
| Rotary knob..... | 3.2 |
| data variation..... | 3.10 |
| RS-232 interface..... | 8.5 |
| configuration..... | 5.6 |
| RX Path..... | 4.93, 4.95, 6.59, 6.60 |

S

| | |
|---|------------------------|
| SAMPlE command..... | 5.40 |
| Save..... | 4.29 |
| all..... | 6.32 |
| current..... | 6.32, 6.37 |
| Save to File..... | 4.33, 4.35 |
| Scalar measurement results..... | 5.38 |
| Scaling Mode..... | 4.49, 4.66 |
| Scan disk..... | 1.37 |
| SCPI | |
| Error messages..... | 9.1 |
| standard..... | 5.1 |
| status register..... | 5.16 |
| SCPI Connection..... | 4.11 |
| Screen saver..... | 4.20 |
| Screen-Dump..... | 4.5 |
| Screensaver..... | 6.36 |
| Second AF channel..... | 6.117, 6.140 |
| Secondary address..... | 5.23, 6.14 |
| program example..... | 7.1 |
| remote control..... | 5.2 |
| Secondary Address..... | 4.12 |
| Secondary audio circuit..... | 6.107 |
| Select Maintenance..... | 4.26 |
| Select field..... | 3.14 |
| Selftest..... | 4.26 |
| Sequence Length (gen. listmode)..... | 4.82, 4.83 |
| Serial interface..... | 8.5 |
| Serial poll..... | 5.25 |
| Service request (SRQ)..... | 5.24 |
| Service request enable register (SRE)..... | 5.20 |
| Setting commands..... | 5.7 |
| Setting up (CMU)..... | 1.11 |
| Settings table..... | 3.7, 4.45 |
| Setup..... | 4.9 |
| remote control..... | 6.13 |
| Setup (table)..... | 4.101 |
| Setup Comm..... | 4.15 |
| Setup Misc..... | 4.20 |
| Setup Options..... | 4.16 |
| Setup Remote..... | 4.11 |
| Setup TCP/IP..... | 4.21 |
| Setup Time..... | 4.19 |
| Short form (commands)..... | 5.9 |
| Sign..... | 5.11 |
| Signal, AF generator..... | 4.104 |
| Signalling..... | 3.6, 3.16, 4.7 |
| SINAD..... | 4.101 |
| Single shot..... | 4.47 |
| Single Shot..... | 5.36 |
| Single side band..... | 4.130, 4.132 |
| Single Side Band..... | 4.78 |
| Slope (trigger)..... | 4.93 |
| Softkey | |
| function..... | 3.2, 3.6 |
| selection..... | 3.2, 3.6 |
| Software installation, Remote Service Tool..... | 1.21 |
| Software update..... | 1.20 |
| Software version selection dialog..... | 1.32 |
| Source/Content..... | 4.33 |
| Span | |
| Power..... | 4.49, 4.52, 6.59, 6.65 |
| Spectrum..... | 4.49, 4.59, 6.59, 6.71 |
| Special characters..... | 6.2 |
| Spectrum..... | 4.49, 4.58 |
| Spectrum Configuration..... | 4.49, 4.64 |
| Spectrum measurement | |
| remote control (RF)..... | 6.59, 6.69 |
| RF..... | 4.49, 4.57 |
| SPEECH (connector)..... | 8.13 |
| Square brackets..... | 5.9, 6.2 |
| SRE (service request enable register)..... | 5.20 |
| SRQ (service request)..... | 5.24 |
| SSB..... | 4.78, 4.130, 4.132 |
| Standby mode..... | 1.13, 2.5 |
| Start..... | 4.49, 4.59, 6.59, 6.71 |
| Startup..... | 4.1 |
| Startup menu..... | 1.14, 2.4 |
| Startup test..... | 4.1 |
| Statistic Count..... | 3.18, 5.36 |
| Analyzer/Generator..... | 4.48 |
| Power..... | 4.49, 4.55 |
| Spectrum..... | 4.49, 4.65 |
| Statistical quantities..... | 3.20 |
| Statistics..... | 5.36 |
| Statistics cycle..... | 3.18 |
| STATUS | |
| OPERation-Register..... | 5.22 |
| QUESTIONable-Register..... | 5.23 |
| Status byte (STB)..... | 5.20 |
| Status register | |
| overview..... | 5.18 |
| structure..... | 5.16 |
| Status reporting system..... | 5.16 |
| STB (status byte)..... | 5.20 |
| Step Length..... | 6.99, 6.102 |
| Stepping mode..... | 5.32 |
| Audio..... | 6.111 |
| IQSLot..... | 6.99, 6.101 |
| Multitone..... | 6.119, 6.130 |
| Power..... | 6.59, 6.63 |
| RF analyzer..... | 6.44 |
| Spectrum..... | 6.59, 6.71 |
| THD..... | 6.142, 6.147 |
| Stereo (Multitone)..... | 4.108 |
| Stop..... | 4.49, 4.59 |
| Stop bit (RS-232)..... | 8.7 |
| Stop Bits..... | 4.15 |

| | |
|---|--------------|
| Stop Condition..... | 3.19 |
| Audio..... | 6.111 |
| IQSLot..... | 6.99, 6.101 |
| Multitone..... | 4.113 |
| Multitone..... | 6.119 |
| Multitone..... | 6.130 |
| Power..... | 6.59, 6.63 |
| RF analyzer..... | 6.44 |
| Spectrum..... | 6.59, 6.71 |
| THD..... | 6.142, 6.147 |
| Storing..... | 8.1 |
| Structure | |
| command..... | 5.8 |
| command line..... | 5.10 |
| Subarrays..... | 5.38 |
| I/Q Recorder..... | 6.82, 6.87 |
| IQSLot..... | 6.99, 6.104 |
| Multitone..... | 6.120 |
| Power..... | 6.59, 6.66 |
| Spectrum..... | 6.59, 6.73 |
| Subnet mask..... | 6.20, 6.24 |
| static..... | 6.20, 6.22 |
| CMU-B21..... | 4.21, 4.22 |
| CMU-B83..... | 4.21, 4.23 |
| Sum bit..... | 5.17 |
| Switching on..... | 1.13 |
| Symbolic evaluation of status register..... | 5.25, 6.12 |
| RF..... | 6.38 |
| Symbolic Measurement Ready Evaluation..... | 5.33 |
| Sync. (synchronization) | |
| RF..... | 4.89 |
| remote control..... | 6.33 |
| internal/external..... | 4.90 |
| remote control (NS)..... | 6.59 |
| System clock..... | 4.89 |
| System Reboot..... | 6.8 |

T

| | |
|-------------------------------|------------------|
| Tab..... | 3.8 |
| Table (expand)..... | 3.8 |
| Task Priority Management..... | 4.12, 5.44, 6.15 |
| TCP/IP (Setup)..... | 4.21 |
| TCP/IP Settings..... | 6.20 |
| Test, Maintenance..... | 4.29 |
| Test mode..... | 3.16, 4.7 |
| Test modulation..... | 4.78 |
| THD, remote control..... | 6.140 |
| THD (control)..... | 4.120, 4.120 |
| remote control..... | 6.142, 6.147 |
| THD + N..... | 4.101 |
| THD Configuration..... | 4.120 |
| remote control..... | 6.142 |
| Time..... | 4.19 |
| Time (Setup)..... | 4.19 |
| remote control..... | 6.18 |
| Time Scale..... | 6.59, 6.65 |

| | |
|--|------------------------|
| Power..... | 4.49, 4.52 |
| Time Scale Span..... | 4.49, 4.52 |
| Time Scale Start..... | 4.49, 4.52 |
| Tips and Tricks..... | 7.7 |
| Tone Def. (Multitone)..... | 4.115, 6.123, 6.134 |
| Tone Definitions..... | 4.116 |
| Tone Scale..... | 4.110 |
| Total Harmonic Distortion and Noise..... | 4.101 |
| Total Level..... | 4.116, 6.124, 6.135 |
| Trace..... | 5.36, 5.37 |
| Transmission reserve..... | 4.73, 4.75 |
| Trigger | |
| Non Signalling..... | 4.92 |
| remote control (RF)..... | 6.41 |
| Trigger delay, I/Q Recorder..... | 6.82, 6.85 |
| Trigger Level, Non Signalling..... | 4.93 |
| Trigger Offset..... | 6.99, 6.102 |
| Trigger output, connector..... | 8.12 |
| Trigger Slope..... | 6.41, 6.42 |
| Trigger Source..... | 4.92, 6.41 |
| Tx / Aux Tx..... | 4.84 |
| TX Path..... | 4.93, 4.95, 6.59, 6.60 |
| Type of CMU IP addressing..... | 4.21, 4.22, 6.20, 6.21 |

U

| | |
|----------------------------------|---------------------|
| Unit..... | 5.10 |
| I/Q Recorder..... | 6.82, 6.86 |
| Universal commands..... | 8.4 |
| Upgrade firmware..... | 1.32 |
| Upper Limit Line, Multitone..... | 4.115, 6.121, 6.132 |
| Upper/lower case (commands)..... | 6.2 |
| USB connector..... | 8.11 |
| User correction (tables)..... | 1.39 |
| USERCOR1.DAT..... | 1.42 |

V

| | |
|-------------------------|--------------|
| Variable band pass..... | 4.106, 6.112 |
| Versions.new..... | 1.28 |
| VGA monitor..... | 1.18 |
| View Info/Rename..... | 4.38 |

W

| | |
|------------------------------|------------------------|
| Wait..... | 4.2 |
| Weighting filter..... | 4.106, 4.117, 4.122 |
| Wideband Power, RF..... | 4.86, 4.87, 6.59, 6.77 |
| Winbatch..... | 7.3 |
| Write log files to disk..... | 1.37 |

X

| | |
|---------------|------|
| XMAXimum..... | 5.39 |
| XMINimum..... | 5.39 |